

EMSKE 50 EMV-Z

Ex-EMC-cable gland, brass with short thread

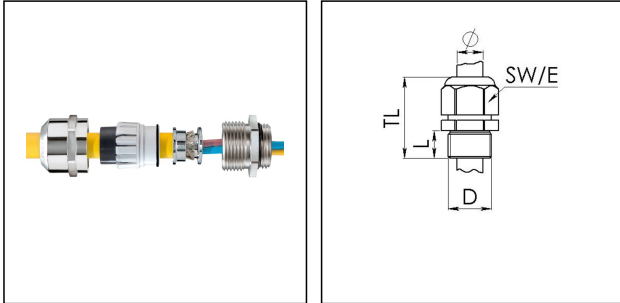

Product illustrations are exemplary and may differ from the chosen product. Further variants and individual customization, we will gladly provide you on request.



Material cable gland	Brass nickel-plated
Material clamping cage	Polyamide
Material sealing gasket	EPDM
Temp. range min	-40 °C
Temp. range max	75 °C
Protection class	IP 66 / IP 68, 5 bar 30min
Marking	II 2 D Ex tb IIIC Db IP68, II 2 G Ex e IIC Gb
Approval	PTB 04 ATEX 1112 X
Thread type	M
Connection thread size D	50
Lead	1,5
Length screw-in thread L	9 mm
Cable diameter min	21 mm
Cable diameter max	35 mm
Cable Diam. below cable shield	33 mm
Cable Diameter UL	24,3 mm - 33,4 mm
Key width SW	55 mm
Collar diameter (E)	61 mm
Total length TL	51 mm - 62 mm
Install. torques fitting	30 N m
Install. torques cap nut	30 N m
Type of cable anchorage	A
Impact category	6
Surface	Nickel-plated
Order no. nickel-plated	10065062

Type	EMSKE 50 EMV-Z
Packing unit	10
ETIM-Classification	EC000441

Recommended accessories

RDE 50	10062188
EMMU-EMV 50	10063216
BS 25	10064015
BS 35	10064017

23.02.2015