

EMSKE 32 EMV-S

Ex-EMC-cable gland, brass

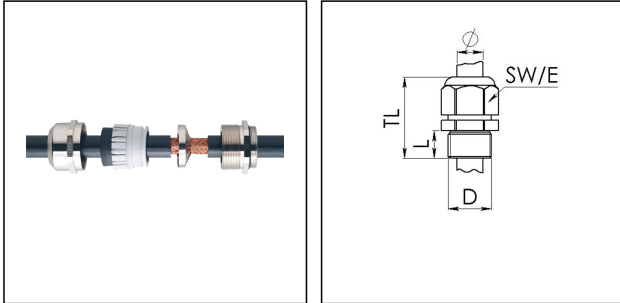

Product illustrations are exemplary and may differ from the chosen product. Further variants and individual customization, we will gladly provide you on request.



Material cable gland	Brass nickel-plated
Material clamping cage	Polyamide
Material sealing gasket	EPDM
Temp. range min	-40 °C
Temp. range max	75 °C
Protection class	IP 66 / IP 68, 5 bar 30min
Marking	II 2 D Ex tb IIIC Db IP68, II 2 G Ex e IIC Gb
Approval	PTB 04 ATEX 1112 X
Thread type	M
Connection thread size D	32
Lead	1,5
Length screw-in thread L	8 mm
Cable diameter min	13 mm
Cable diameter max	21 mm
Cable Diam. below cable shield	20 mm
Key width SW	36 mm
Collar diameter (E)	40 mm
Total length TL	36 mm - 44 mm
Install. torques fitting	20 N m
Install. torques cap nut	20 N m
Type of cable anchorage	A
Impact category	6
Surface	Nickel-plated
Order no. nickel-plated	10102975
Type	EMSKE 32 EMV-S

Recommended accessories

RDE 32	10062186
EMMU-EMV 32	10063214
BS 14	10064011
BS 21	10064014

23.02.2015