

EMSKE 12 EMV-S

Ex-EMC-cable gland, brass

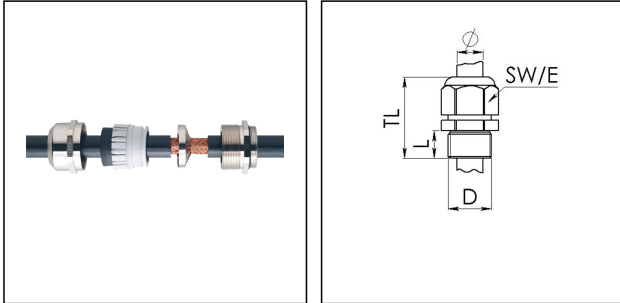

Product illustrations are exemplary and may differ from the chosen product. Further variants and individual customization, we will gladly provide you on request.



Material cable gland	Brass nickel-plated
Material clamping cage	Polyamide
Material sealing gasket	EPDM
Temp. range min	-40 °C
Temp. range max	75 °C
Protection class	IP 66 / IP 68, 5 bar 30min
Marking	II 2 D Ex tb IIIC Db IP68, II 2 G Ex e IIC Gb
Approval	PTB 04 ATEX 1112 X
Thread type	M
Connection thread size D	12
Lead	1,5
Length screw-in thread L	5 mm
Cable diameter min	4 mm
Cable diameter max	7 mm
Cable Diam. below cable shield	5 mm
Key width SW	16 mm
Collar diameter (E)	18 mm
Total length TL	23 mm - 30 mm
Install. torques fitting	4 N m
Install. torques cap nut	4 N m
Type of cable anchorage	A
Impact category	6
Surface	Nickel-plated
Order no. nickel-plated	10102971
Type	EMSKE 12 EMV-S

Recommended accessories

RDE 12	10062183
EMMU-EMV 12	10063210
BS 3	10064001
BS 7	10064005

23.02.2015