



AOKLY GROUP

12V Lithium Ion Battery Quick Guidance

Version: 1.0

Date: 2024-03

版权©广东奥克莱集团有限公司

Copyright Guangdong Aokly Group Co. Ltd

Without consent of the Company, no unit or individual may excerpt or duplicate the document in part of in whole, or disseminate any content in any way.

Trademark Gazette



AOKLY GROUP and other trademarks of Aokly Group belong to Guangdong Aokly Group Co.Ltd, and all other trademarks or registered trademarks as referred to herein belong to their respective owners.

Declaration

- 1.The Manual covers the detailed specification of lithium iron phosphate battery pack; please read the instructions carefully before operation and comply with relevant industrial safety regulations. We accept no responsibility for damages arising from improper operation or any operation in violation of provisions as stipulated herein.
2. The document is subject to change by virtue of product version update or other reasons without prior notice. Unless otherwise agreed herein, the document is only used as the guideline, and no presentations or suggestions may constitute any express warranty.

Contact Information:

Address: Hi-Tech development zone,Yingde City,Guangdong Province,China Tel.:

+86-20-86861998

Safety Instruction

Please read the safety instructions before operating the equipment. The safety precautionary measures as mentioned herein are only used as the supplement to all safety precautions, without representing all safety precautions to be complied with. Please comply with local safety rules and regulations when installing, operating and maintaining the equipment. Only trained professionals are allowed to install, operate and maintain the equipment, and Aokly Group assumes no responsibility for losses arising from violating the general safety operation requirement or violating the safety standard for equipment design, production and use. Installation and maintenance personnel must have the technical ability of operation in high voltage and AC power supply. Do not wear any conductive object such as watch, chain bracelet, bracelet and ring when installing, operating and maintaining the equipment, and keep the equipment away from moisture.



Danger! High Voltage

The high voltage power supply offers the equipment power; direct contact or indirect contact through wet object with high-voltage power supply may cause fatal danger.



Using a special tool:

Working in high voltage and AC power, make sure to use a special tool instead of individual tools.



Static-free:

Static electricity would damage veneer on the electrostatic sensitive components; before touching the plug-in, circuit board or chips, make sure to use correct electrostatic prevention measures.



Disconnect the power supply in operation:

When operating the power supply, you must first cut off power supply, live operation is prohibited.



Disconnect the power supply in operation:

Power system provides DC regulated power supply. DC short circuit could cause fatal damage to the equipment.

目录 Content

1. 产品介绍 Product Introduction	5
1.1 电池充电曲线 Battery discharge curve (@25°C)	5
1.2 充电概况 Charge profiles	5
1.3 电池管理系统 Battery Management System	5
1.3.1 电池管理系统的功能 The functions of a BMS are:	5
1.3.2 保护功能 Protection Function	6
1.4 电缆 Cable	6
2. 电池串联和并联使用 Battery series and parallel use	6
2.1 串联模式 Series connection mode	6
2.2 并联 Parallel connection	7
3. 操作和维护 Operation & Maintenance	7
3.1 操作环境要求 Requirements for Operation Environment	7
3.2 定期维护 Periodic maintenance	7
3.3 储存 Storage	8
4. 一般规则 General rules	8
5. 电池环境 Battery environment	9
5.1 通风 Ventilation	9
5.2 电池位置 Battery orientation	9
5.3 电池环境 Battery environment	9
6. 故障排除和解决方案 Troubleshooting & Solutions	9
7. 电池参数 Battery Parameters	10
8. 附录 appendix	

1. Product Introduction

Lithium iron phosphate (LiFePO₄ or LFP) is the safest of the mainstream li-ion battery types. The nominal voltage of a LFP cell is 3.2V (lead-acid: 2V/cell). A 12.8V LFP battery therefore consists of 4 cells connected in series; and a 25.6V battery consists of 8 cells connected in series. This product is widely used in solar/wind energy storage, golf cart, back-up powers for UPS/EPS, tools and so on.

1.1 Battery discharge curve(@25°C)

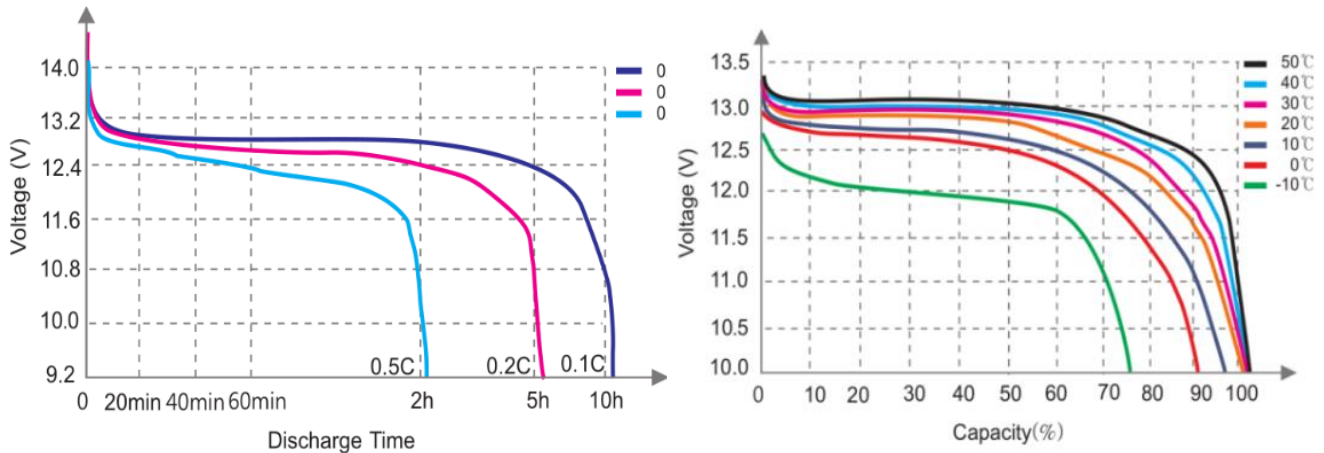

Discharge curves of different currents

Discharge curves at different temperatures

1.2 Charge profiles

Batteries must be charged using a dedicated lithium battery charger. For 12V series batteries, use a 14.6V charger, and for 24V series batteries, use a 29.2V charger. Note that the charging current should be within the specified value.

Standard charge mode:

For 12V series batteries at 5°C~45°C temperature, charged to 14.6V at a constant current of 0.2C, and then charged continuously with constant voltage of 14.6V until the current was current is less than 0.02C.

For 24V series batteries at 5°C~45°C temperature, charged to 29.2V at a constant current of 0.2C, and then charged continuously with constant voltage of 29.2V until the current was current is less than 0.02C.

1.3 Battery Management System

1.3.1 The functions of a BMS are:

If the battery voltage is too low, the battery disconnects the load in time to prevent the battery voltage from being too low.

When the battery is charged, if the voltage is too high, it will actively stop charging to prevent the battery from overvoltage.

If the battery temperature is too high, the output is turned off.

Therefore, in order to prevent damage to lithium ion batteries, BMS is essential.

A BMS is therefore indispensable to prevent damage to Li-ion batteries.

1.3.2 Protection Function

1. Over charge voltage protection
2. Over discharge voltage protection
3. Over current protection
4. Temperature protection
5. Short circuit protection

1.4 Cable

Battery cables should be sized to handle the expected load. Refer to Table 3-1 for the maximum amperage based on the cable/wire gauge size.

Table

Cable/wire size (mm ²)	1	1.5	2.5	4	6	16	25
DC current (A)	18	22	30	39	50	90	120

Note1: Above load base on single copper cable/wire

Note2: lithium ion batteries no need any communication cable.

2. Battery series and parallel use

A 12V battery can be used in series with a maximum of four batteries or four batteries in parallel, Do not exceed this amount, otherwise it will cause battery damage

Before connecting batteries in parallel or series, ensure that the differential pressure between batteries is less than 0.6V to avoid capacity loss and safety risks caused by inconsistent differential pressure between batteries

In order to keep the battery differential pressure under 0.6V, Before connecting the batteries in series, discharge single 12V battery and connect the batteries in series after discharging all the batteries ;

You can increase capacity by connect batteries in parallel, or increase voltage by connect batteries in series, or both, make sure no more than 4 batteries in one bank.

Connection diagram as following:

2.1 Series connection mode

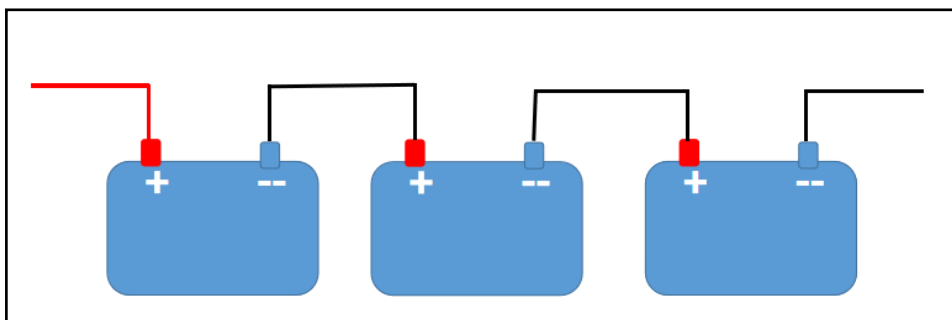

2.2 Parallel connection

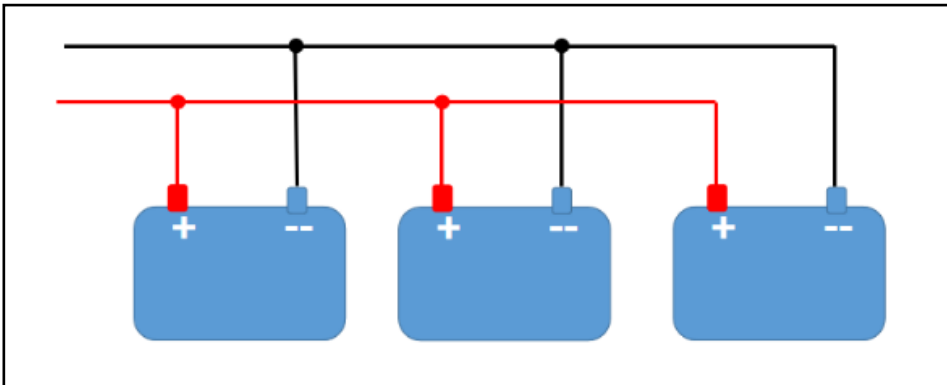

- Connect battery first and make sure external power device is turned off before wiring connection.
- Length of cable between battery module and power plant shall be less than 2.0m. To make sure similar voltage drop of cable for each battery, length of all positive and negative cables should be the similar.
- Color for cable between '+' and positive bus-bar is suggested as red, and cable between '-' and negative breaker or fuse as black or blue.

3. Operation & Maintenance

3.1 Requirements for Operation Environment

Temperature Range (°C)	Discharge	-20 ~ +60
	Charge	0 ~ +45
	Storage	0 ~ +45
Recommended Temperature (°C)	Discharge	+15 ~ + 35
	Charge	+15 ~ + 35
	Storage	+15 ~ + 30
Humidity		5% ~ 90%

3.2 Periodic maintenance

In order to improve the system operation and reliability, it is recommended to complete maintenance operation regularly:

- Please use clean and dry cloth/fabric to clean up the battery and cabinet, if need further cleaning, please use neutral cleanser. Alcohol or ammonia synthesis is forbidden. Pay attention to avoid short

circuit.

- Carrying shall be handled gently, prevent from severe compact
- Prevent battery from splashing liquid
- It is recommended to check the circuit and battery operation every three months

3.3 Storage

- The battery storage shall be in the clean, cool room and temperature no more than 45°C.
- Storing a battery after discharging can result in permanent damage or reduced running time. Before storing the battery for a long time, charge it fully.
- The batteries shall be charged every 6 ~ 12 months (0 ~ 30°C - 12 months, 30 ~ 45°C - 6 months) during storage.

4. General rules



Observe these instructions and keep them located near the Li-ion Battery for future reference. Work on the Li-ion Battery should be carried out by qualified personnel only.



Any uncovered battery material such as electrolyte or powder on the skin or in the eyes must be flushed with plenty of clean water immediately. Then seek medical assistance. Spillages on clothing should be rinsed out with water.



Explosion and fire hazard. Terminals of the Li-ion Battery are always a live; therefore do not place items or tools on the Li-ion Battery. Avoid short circuits, too deep discharges and too high charge currents. Use insulated tools. Do not wear any metallic items such as watches, bracelets, et cetera. In case of fire, you must use a type D, foam or CO2 fire extinguisher.



Never try to open or dismantle the Li-ion Battery. Electrolyte is very corrosive. In normal working conditions contact with the electrolyte is impossible. If the battery casing is damaged do not touch the exposed electrolyte or powder because it is corrosive.



Too deep discharges damage the Li-ion battery seriously and can even be dangerous. Therefore, use of an external safety relay is obligatory.



Li-ion Batteries are heavy. If involved in an accident they can become a projectile! Ensure adequate and secure mounting and always use suitable handling equipment for transportation. Handle with care because Li-ion Batteries are sensitive to mechanical shock.

Disposal of Li-ion batteries

Batteries marked with the recycling symbol must be processed via a recognized recycling agency. By agreement, they may be returned to the manufacturer. Batteries must not be mixed with domestic

or industrial waste.

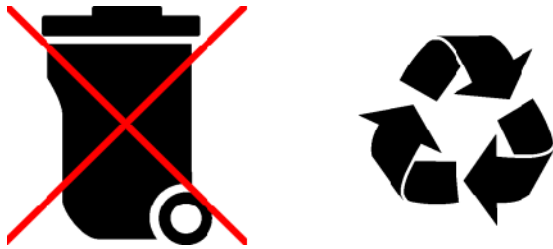

Non-compliance with operating instructions. repairs made with other than original parts. or repairs made without authorization render the warranty void.

5. Battery environment

5.1 Ventilation

Batteries do not release gas during normal use. There are no specific ventilation requirements for batteries installations, although sufficient airflow should be provided to prevent excessive heat build-up.

5.2 Battery orientation

Batteries may be installed in any horizontal or vertical orientation except with the terminals facing downward.

5.3 Battery environment

Batteries should be stored and installed in a clean, cool and dry place, keeping water, oil, and dirt away from the batteries. Battery chargers should also be installed in well-ventilated, clean areas that are easily accessible. Relative humidity should be <90%.

6.Troubleshooting & Solutions

Troubleshooting and Solutions

Troubles	Troubleshooting	Solutions
Battery cannot discharge	Protection against under-voltage	Charge battery
	Protection against over-temperature or under-temperature	Regulate ambient temperature in the range of 5°C to 45°C for discharge
	Battery output is short circuit	Relieve short circuit and charge battery
	Protection against over-current	Remove some unimportant load and charge battery



Troubles	Troubleshooting	Solutions
Battery cannot charge	Battery is fully charged. Normal charge management	Do not need to solve
	Protection against over-voltage	Do not need to solve
	Protection against over-temperature or under-temperature	Regulate ambient temperature in the range of 5°C to 45°C for charge

7. Battery Parameters

Model	Charging Voltage (V)	Maximum discharging current	Size W*D*H(mm)	Weight (Kg)
ALFP-12100	14.6V	100A	329*172*219mm	10.0Kg
ALFP-12150	14.6V	150A	483*170*240mm	17Kg
ALFP-12200	14.6V	200A	522*218*240mm	22Kg

8. Appendix

APP Download instructions

Step 1

Scan the QR code to download the app
Supports Android and Apple systems



xiaoxiangElectric

Step 2

Choose to open in browser, Follow the prompts to download the corresponding operating system app

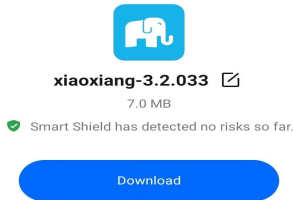

Step 3

Open the software and enter the app to register or log in to an account

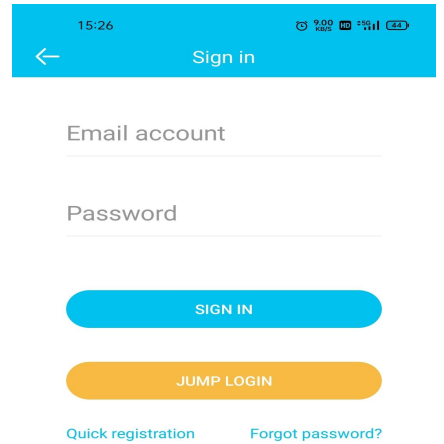

Step 4

After successful login, the app will automatically redirect to the <Device List> interface, Select the device you want to connect to on this interface (According to the MAC address on the back of the Bluetooth module or the built-in Bluetooth aluminum sticker, as shown in the following figure) Or scan the MAC QR code to directly connect to the device.

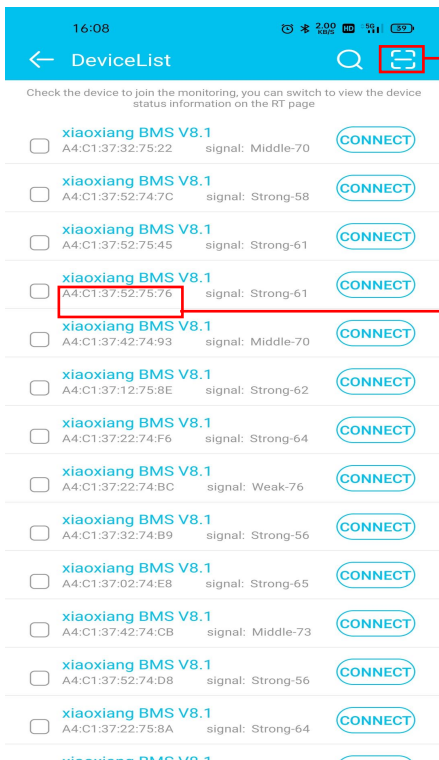

method 1
Scanning the MAC QR code of the tag allows direct access to the corresponding device

Bind device after successful connection

method 1
Select the MAC address of your corresponding device and click connect

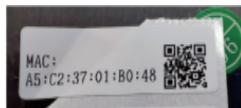

Built in Bluetooth sticker MAC address



MAC address on the back of the Bluetooth module

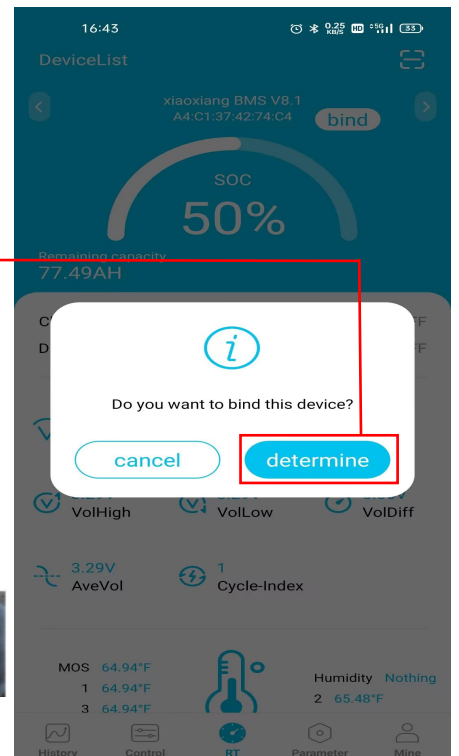

APP interface usage instructions

(real time)interface 1

SOC display drawing, charging switch, discharge switch, Equilibrium state, Multiple temperature parameters, Protection status, And real-time data display.As shown in the following figure.

The initial connection to SOC may not be accurate. Based on the battery pack's capacity setting and 1-2 charging and discharging cycles, SOC will automatically calibrate

Only when the set pressure difference and equilibrium value are reached will the equilibrium be automatically turned on

If the protection board is unable to output protection, there will be a protection status prompt here; Single string undervoltage protection

Discharge is negative, charging is positive; If charging 5A, it will display 5A; Discharge 5A, display -5A

When the cumulative discharge capacity exceeds the set parameter cycle capacity, the number of cycles will be increased once. Charging midway does not affect the measurement

(control)interface 2

Charge switch, discharge switch, and control BMS board data by issuing commands through the APP.As shown in the following figure.

Control the charging and discharging button. If it is turned on, it is in the charging and discharging on state. On the contrary, it is in a closed state

(parameter)interface 3

Basic information, initial settings, as shown in the following diagram.

Basic information interface

Password settings interface

The diagram shows three mobile app screens. The first screen, titled 'Parameter', has a menu with 'Basic Information' and 'Origin Setting'. The second screen, 'Basic Information', shows a 'Bluetooth name' field with the value 'xiaoxiang BMS V8.1' and a 'Set' button. A red box around this field is annotated with 'Customizable Bluetooth name (distinguishing different Bluetooth devices)'. The third screen, 'Password Settings', shows a 'Set the password' field with a 'Set' button. A red box around this field is annotated with 'Can set a six digit connection password; After setting up, enter the password to enter the APP' and 'If you forget your password, you can click <Connect Password> > 5 times in a row to enter management mode, Enter the management password to enter the app and clear the connection password at the same time'. A bottom navigation bar contains icons for History, Control, RT, Parameter, and Mine.

(history)、(mine)interface 4

Display the variation curves of battery maximum and minimum voltage, battery current, remaining capacity, temperature, and other data. Display the last 100 pieces of data, one per minute, as shown in the following figure.

The diagram shows two mobile app screens. The left screen, 'History', displays two line graphs. The top graph plots 'Volt/V' (0 to 3.0) and 'Current/A' (-1.2 to 1.2) over time. The bottom graph plots 'Cap/AH' (0 to 70.0) and 'Current/A' (-1.2 to 1.2) over time. A red box points to the graphs with the text 'Connecting to the APP will record data and generate a curve graph'. The right screen, 'Mine', shows a user profile with ID '13727537448' and a list of settings: 'Perfect data', 'Device management', 'Ignore battery optimization', 'Exit account', and 'Version V 3.2.033'. A red box around 'Device management' is annotated with 'View or unbind bound devices'. A bottom navigation bar contains icons for History, Control, RT, Parameter, and Mine.