

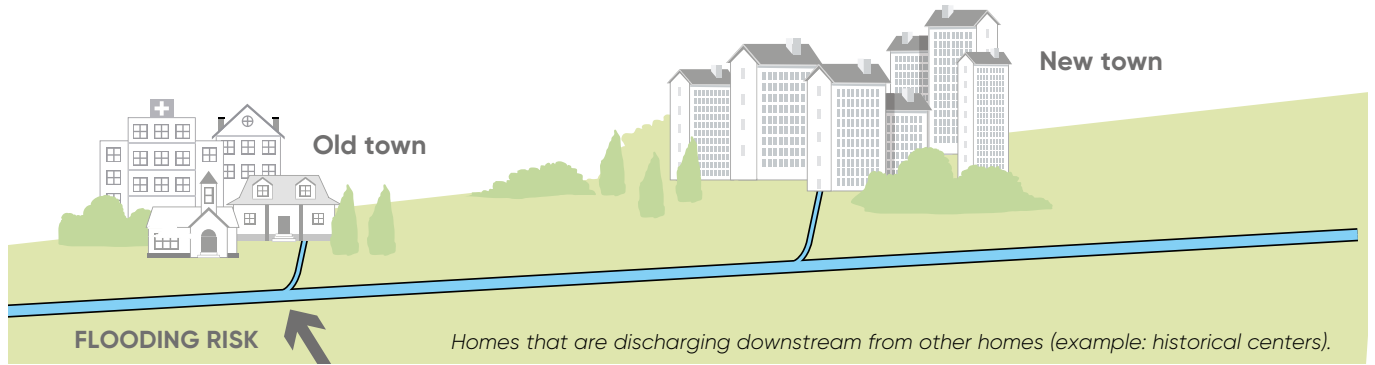

## Ottima and Classica non-return valves

# Reasons to install backflow prevention device



## The causes of backflow

Back flow from the public sewer system is mainly caused by:

- overall under-sizing of the public sewers
- high peak flows in stormwater sewers or combined sewers due to short but intense rainfall (climatic trend throughout the world)
- increase of surface water runoff due to new construction (growing territorial urbanization), causing greater volume of flow
- overflow due to peaks of simultaneous flow in built up areas
- malfunctions or blockages downstream from the grid.

The typical situations that may lead to this problem are various and are related to the urban area involved. Several examples:

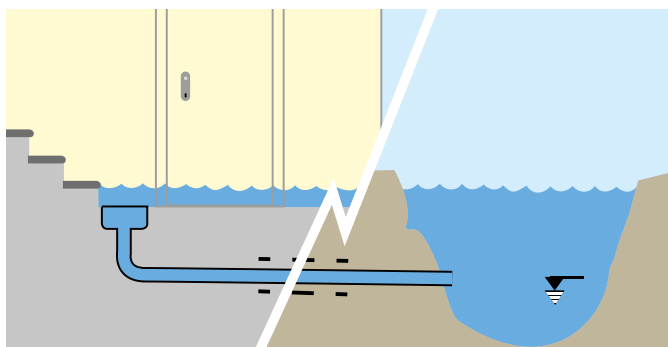
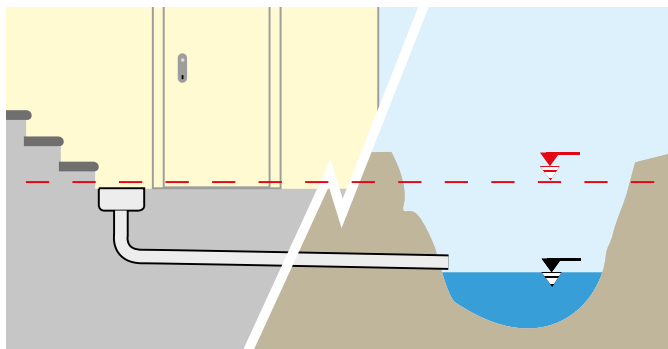

Riverside areas

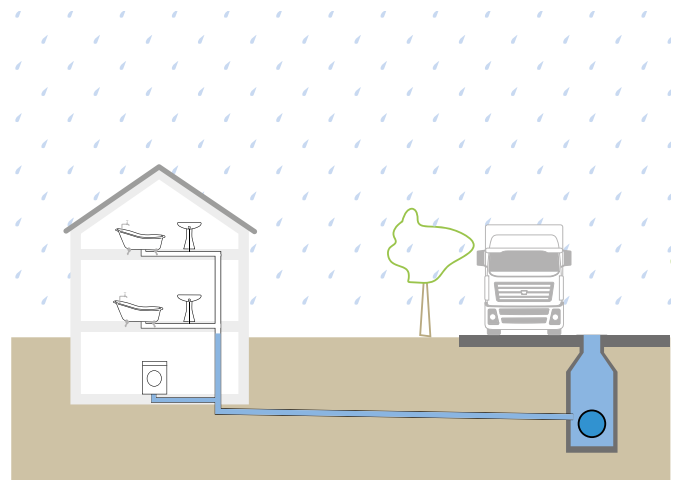

Combined sewers that also collect road drainage

## Basements

These are only some of the many cases in which sewer overflow risk is high and installation of a backflow prevention device is recommended.



## Hydraulic principles: reflux level.

On the grounds of the "Communicating Vessels Principle", water tends to settle at even levels in all branches of the sewer network.

Hence, it is possible to define the concept of "backflow level" as the maximum level in a sewer system before water reflux occurs from the system itself.

All of the utilities below the backflow level of a sewer system (usually basements, cellars and garages, as well as living quarters below street level, face flood risk as grid flows exceed maximum tolerance levels with greater frequency.

Let's schematically examine the consequences of main sewer backflow.

1. Standard use: The main sewer is receptive; the pipes within the home utilities are under safe hydraulic measures.
2. Overflow use – even temporarily: given that the backflow level in this scheme corresponds with street level (over maximum level, which corresponds to manhole height in this case, fluid may seep from the system), any grid overflow shall lead to the distribution of water in all branches communicating with the main sewer, until reaching a back flow level marked with the red dotted line.

Home risk floods following main sewer overflow. The non-return valve is active.

In this case the house is protected against flood risk. This diagram represents a typical scenario that may occur in any home with areas prone to flood risk in regards to the backflow level line.

Unwanted events may take place if the sewer manifold overflows.

Backflow protection may be necessary in separate sewers, where foul and stormwater flow into separate systems, and in cases of combined sewers because backflow typically indirectly involves foul water circuits due to storm water overflow. This problem is normal in areas that do not have separate systems, which concerns the majority of cases.

Discharge water backflow risk is simple to solve by installing a fundamental component in new drainage systems and in modernization of existing grids - the non-return Valve

Its working principle is extremely simple but also very effective.

### NORMAL FUNCTION

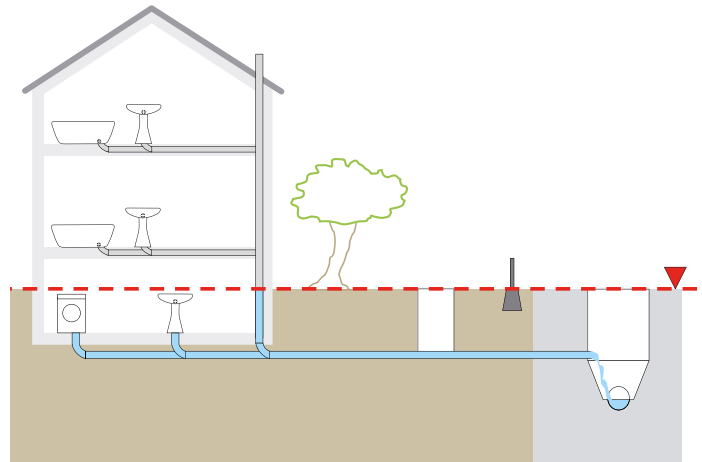

### NON PROTECTED

Back flow event: without non-return valve

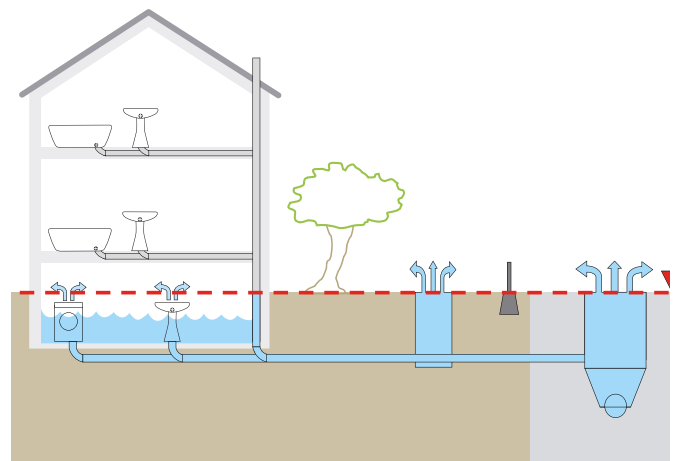

### PROTECTED

Back flow event: with non-return valve

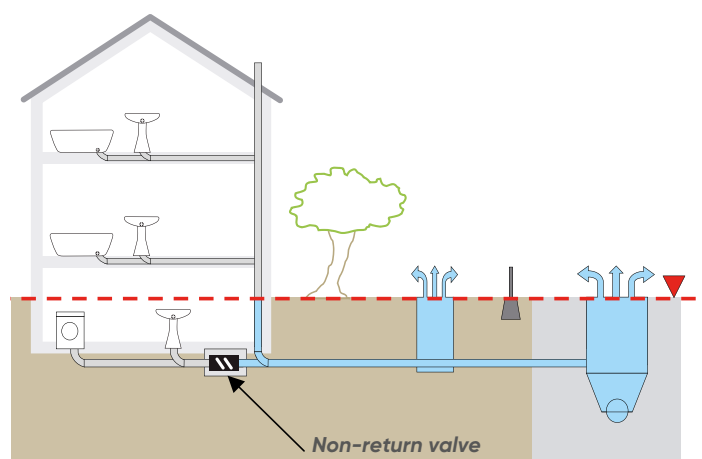

## Legislative aspects of water grid construction and management

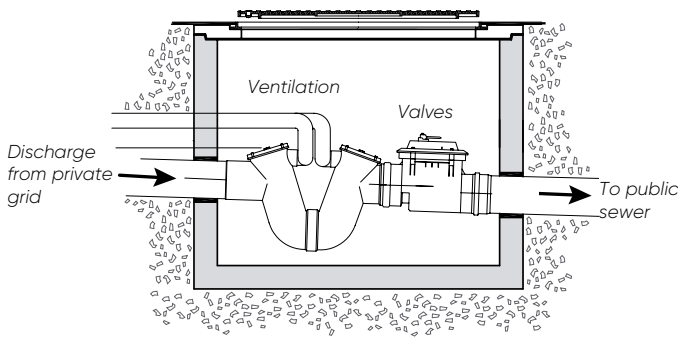

### integrated water utility management

In Italy, as throughout Europe, water grid management has been delegated to Integrated Water Services since the start of the 90s. Water grid management passed from the hands of Municipality Management to subjects referred to as Water Companies, which ensure a benchmark level of quality in return for an utility fee, as by the stipulated utility contract. The various Water Companies in Italy are responsible for service provision and system maintenance and good operating conditions.

Hence, these utilities have introduced a series of technical guidelines concerning various aspects on design and construction of water grids that serve as condition for public and private subjects that intend to benefit from such systems under Contract.

The technical guidelines include the manner of connection to the sewers by private and public users.

### Guidelines

These guidelines must be respected both by enterprises and private citizens alike.

The contractor that executes works for the Utility Company must strictly follow the execution guidelines received. Likewise, the citizen that requires, for example, connection of a new utility must follow these prescriptions according to established procedures.

### Duties

In case of not comply with foregoing prescriptions, the Utility Company is free to decline Contract stipulation for use of public sewer systems; and may press for compensation of any damages caused by the infringing party. Currently, many local Water Companies already expect the installation of a backflow prevention valves when connecting a utility to the public sewers to prevent back flow risk. The image above is an example of prescription. It represents the connection before the public sewage.

## Ottima non-return valve with stainless steel flap AISI 304

The new Ottima non-return valve was designed to meet the highest technological standards on the market. Ottima is manufactured with modern technology that ensures high-product standards and reliability.

### Innovative

The innovation that is expressed through its design:

- increased safety
- search for functionality
- improvement of product features
- new technical requirements

Ottima contains a series of new features that make it a new reference product.



### M/M version is recommended for renovation and installation on pre-existing pipes

The M/M version is a real novelty: this feature, along with its low off-set (7mm – for Ø110 version), actually allows installation on pre-existing piping.

### Costant slope before and after installation

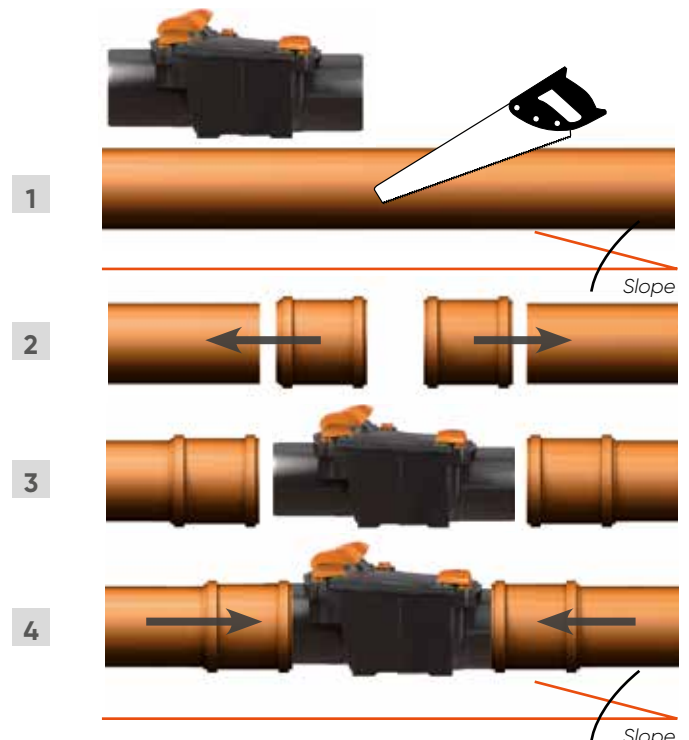

**Minimum offset (7mm)** thanks to the low off-set, pipe slope remains unchanged, both before and after installation.



**Recommended for use with different materials**

The M/M version can be installed on any sort of material. Thanks to the use of transition sleeves, the valve can be mounted in many different materials.

*Example of installation on existing pvc or pp pipes.*



*Transition coupling between different materials*



*Multi-diameter Multi-material*

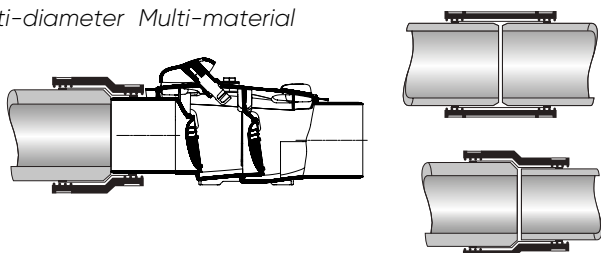

**Double flaps**

Ottima is a Type 2 non-return valve (definition according to standard EN13564), meaning that it is fitted with two automatic protection devices against backflow and with a command seal device. This means double protection in case of backflow and greater guarantee of water-tightness.

**Stainless steel flaps**  
AISI 304



**Opens in extremely reduced spaces** Ottima's cover can be removed without any tools, screwdrivers or wrenches by directly acting on the sealing levers.



*The figure shows valve opening in the vicinity of walls of sewer trap edges. They are manufactured in high-stability nylon polymer for excellent resistance in time, though all parts may be replaced.*



**Standard inox flap:** Ottima is fitted with a series of anti-rodent devices in stainless steel; therefore making it impossible for rodents to travel upwards through water pipelines... Additional protective features!

**No metal parts:** no metal parts ensure resistance to the test of time given the lack of corrosion. All components such as screws, bolts and pins have been eliminated to ensure greater time resistance. The only metal part is the stainless steel anti-rodent device.

**No equipment needed:** Ottima poses a definitive solution to tools required for maintenance. It is designed for full inspection, disassembly and re-assembly without using special tools. Thanks to the lever seal replacing screws and to its internal design, every part can be easily removed and repositioned without the use of special tools.

**Co-injected gaskets:** Ottima is manufactured on a production line that employs management and technology criteria market leading. All seals, spring sheets, lids and couplings are manufactured through direct co-injection. This means that the seals are moulded directly onto the specific part. Therefore, numerous parts are eliminated, water-tightness is increased, maintenance and installation are eased (no gaskets must be removed and remounted, thus eliminating assembly errors).

**Stable base:** Ottima rests on a stable base that facilitates installation and level check operations. But also helps in maintenance, allowing for a stable support.

**Detachable locking lever:** the locking lever is detachable. This is an important feature for installation in public-accessible areas to avoid unauthorized tampering or unwanted actuation. Should the lever be lost, the valve can be locked with a monkey wrench thanks to the hexagonal shape of the mechanism rotational axis. Setting the locking lever in sealed position is fundamental during emergencies that require line cut-off. E.g. downstream maintenance, accidental spillage into sewers. Actuation is confirmed by the "click" sound when locked into place.

## Advice on installation

The non-return valve can be installed both indoors and outside; the installation that allows easy inspection, inside an accessible recess, an inspection pit, or in sight installation on a pipeline with support brackets, is always recommended. Example of indoor installation: in areas such as cellars, washrooms and basements.

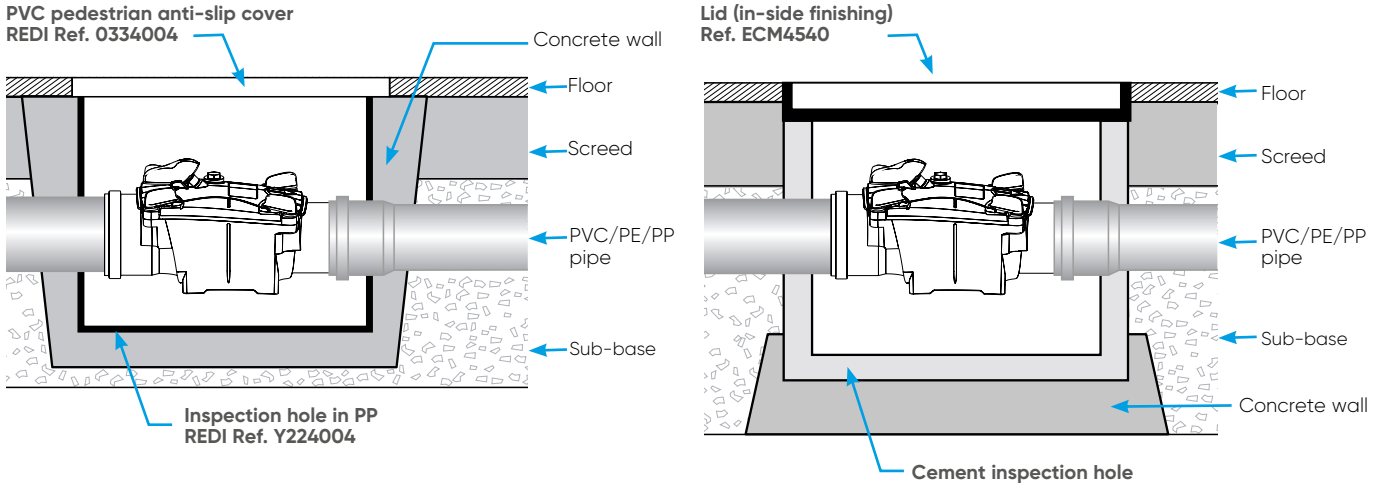

### Examples of installation on an overhead pipeline.

The quota in the examples refer to applications with Ottima Ø100-110, which are greater for Ø125-160.

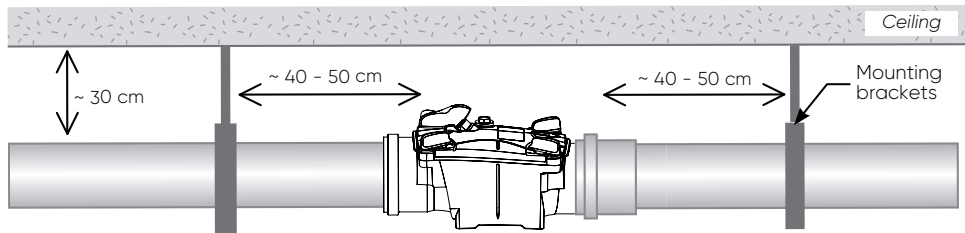

### Example of installation in an overhead pipeline near the ceiling.

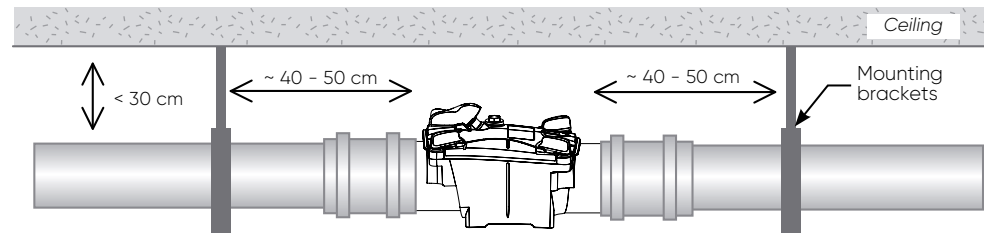

In this case, the Male/Male version allows rapid valve decoupling for inspection and cleaning. This manner of installation is useful for all circumstances of difficult access.

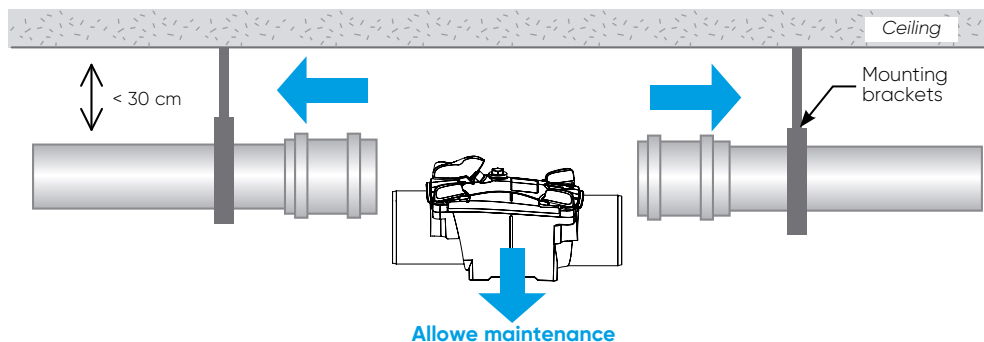

INSTALLATION TYPE

Case 1: Home

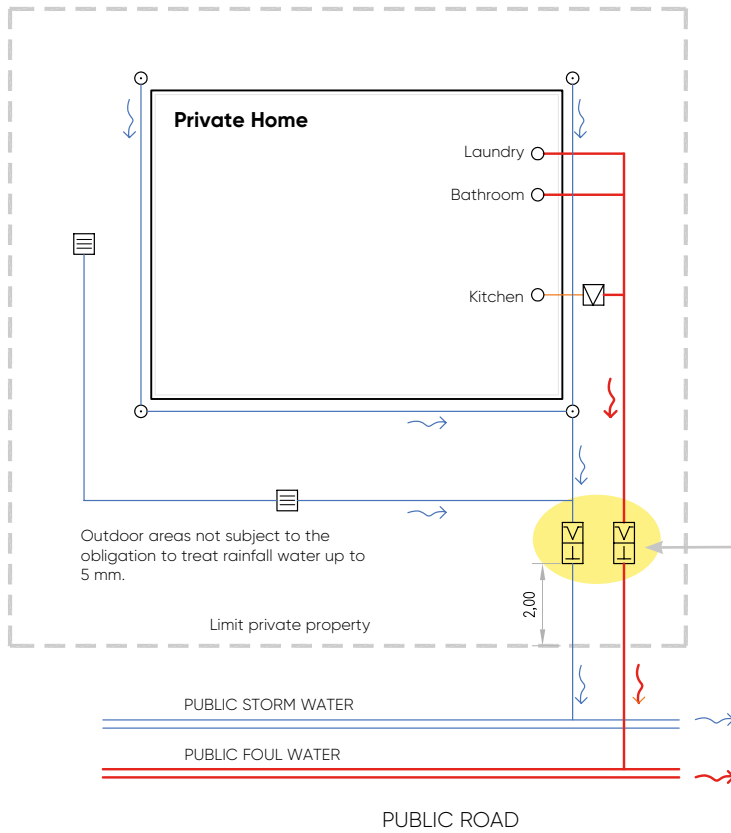

Two examples of non-return valve installation are provided according to Italian laws in force. The first one shows installation in a private home, the second one on a production site. The non-return valve must be installed both on the storm and foul water circuits.

Case 2: Industrial site

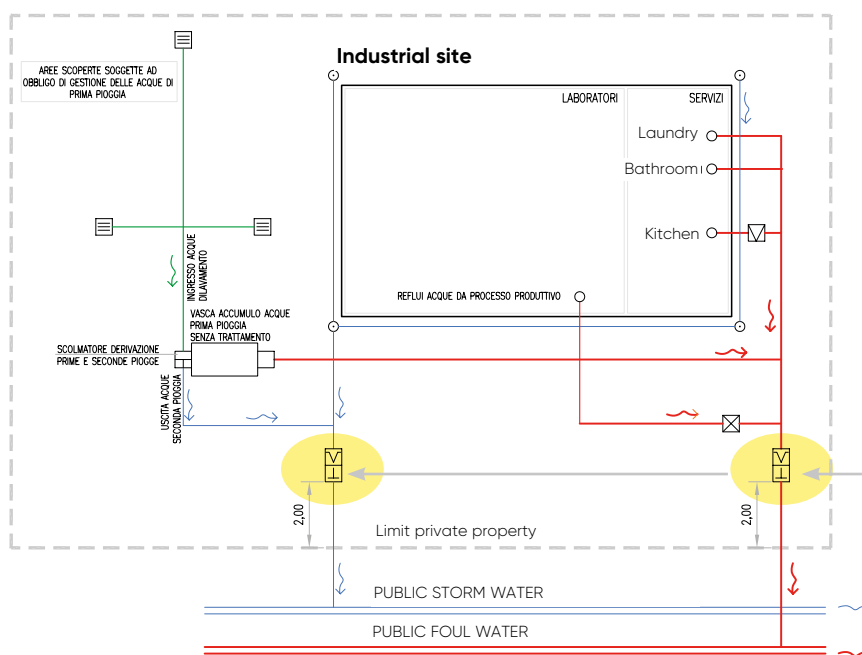

The drawings shown give example of installation in compliance with the most common european standard norms. Regulations may vary according to State and local areas.

## Certification

Redi anti-flooding valves DN 100 ÷ 200 are certified by the German Institute LGA (LGA Kitemark).

Certified anti-flooding valves guarantee the following performance levels:

- Regular flow granted by the opening of the flap, even in presence of minimum pressure rates (0.005 bar).
- Non-deformability and tightness of the product after 600 test cycles at variable temperature (60 seconds at 75° / 60 seconds at 15°).
- Effectiveness of Redi anti-flooding device after 35 cycles of backflow of variable duration from 5 up to 10 minutes and pressure rate from 0,01 up to 0.5 bar.
- Water tightness of the entire valve's body, subject to a pressure rate of 0.5 bar.
- Inlet and outlet of the valves are complying with EN1401 and EN1329.

### CE<sup>11</sup> EN13564: 2002 Antiflooding device made of PVC-U

- Tested features:
- Air proof
  - Thermal resistance
  - Water proof
  - Mechanical resistance
  - Effectiveness test
  - Durability



OTTIMA



OTTIMA



OTTIMA



Classica

## Product specifications

### OTTIMA - Non-return valve Type 2 - (Type 1)

Twin flaps (or single flap) self-closing non-return valve provided with an emergency locking lever.

The device is CE marked, according to the norm EN13564-1 (LGA). Structure and body of the valve are injected in PVC-U.

Joint dimensions are in compliance with EN1401 and EN1329 norms.

The connection to the main can be effected as follows:

- solvent cement
  - push-fit with rubber ring
  - spigot/spigot with multi-material connectors.
- Rubber seals are certified in accordance with the European norm EN681.

By removing the cover of the valve, the structure can be completely inspected. The co-injected seals on the cover (not removable) guarantee the leakage-tightness.

The valve can be assembled and disassembled without using any tool (such as screwdrivers or spanners).

The valve is manufactured to be installed as recommended in EN12056 norm (Installation and testing, instructions for operation, maintenance and use of Waste-water drainage systems).

### Recommended maintenance

According to EN12056, the valve shall be inspected every 6 months by following the inspection procedure:

- remove the cover
- check gaskets conditions
- remove any sludge or debris which could hinder the correct functioning of the device by obstructing the flaps
- lock and unlock the flaps using the locking lever
- assemble and lock the cover again.

Spare parts available on request.

### Classica - Non-return valve

Injection-molded non-return valve made of PVC-U, designed for connections to piping systems conform to EN1329 and EN1401.

- One-flap device with locking lever certified EN13564 Type 1.
- SCJ or RRJ jointing type (Sealing lip-rings conform to EN681-1 and DIN4060).
- Moving parts shall either be detachable or capable of being dismantled on site.
- Airtight and watertight sealed cover.
- CE marking.
- German certification LGA EN13564-1 (DN100 up to DN200)

Suppliers will have to attest that they hold a ISO9001 approved quality system in place as a condition for purchase.

The certificates shown on this catalogue may be subject to revisions and updates. Updated certificates for each product are available on website [www.redi.it](http://www.redi.it)

## NON-RETURN VALVE EN13564-1

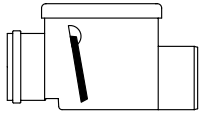
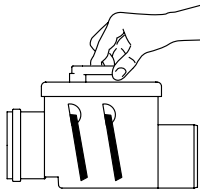
	N° flaps	Emergency closing	Free	Max Temp.	Tightness	Installation	Features
<b>Type 0</b> 	1	NO	90%	75 C°	0,5 bar	horizontal pipe	Equipped with one automatic closing device. Single flap.
<b>Type 1</b> 	1	SI	90%	75 C°	0,5 bar	horizontal pipe	Equipped with one automatic closing device. Single flap. Furthermore it has an emergency closing handle, that can be combined to the flap.
<b>Type 2</b> 	2	SI	90%	75 C°	0,5 bar	horizontal pipe	Equipped with two automatic closing devices. Twin flaps. The emergency closing handle, can be combined with one of both flaps.

## OTTIMA TECHNICAL REQUIREMENTS

Ottima	Ø100	Ø110	Ø125	Ø160
Valve Type	TYPE 1 TYPE 2	TYPE 1 TYPE 2	TYPE 1 TYPE 2	TYPE 1 TYPE 2
Material	U-PVC	U-PVC	U-PVC	U-PVC
EN1401-1329 compliance	OK	OK	OK	OK
Connection type	Glue - M/F - F/F	Glue - M/F - F/F	Glue - M/F - F/F	Glue - M/F - F/F
Fully inspectable	OK	OK	OK	OK
Cover tightness	OK	OK	OK	OK
Removable flap	OK	OK	OK	OK
EN681-1 Seal	OK	OK	OK	OK
EN13564-1	OK	OK	OK	OK
Hot/cold test	OK	OK	OK	OK
Flap tightness	OK	OK	OK	OK
LGA TEST	OK	OK	OK	OK
CE Mark	OK	OK	OK	OK

**TYPE 2**



**Single Socket - RRJ - All plastic smooth materials ØOD**  
**Clapet anti-retour en PVC injecté M/F à joint, 2 clapets**  
**Válvula anti-retorno M/H con junta labiada, clapeta doble**

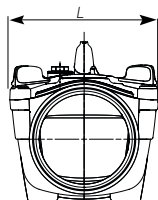
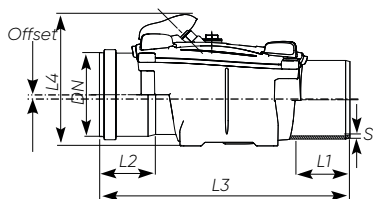

DN (mm)	Reference Black			S (mm)	L (mm)	L1 (mm)	L2 (mm)	L3 (mm)	L4 (mm)	Offset (mm)	Note
100	12R1048	1	60	3,0	171	60	57	338	184	7	
110	12R1148	1	60	3,2	171	65	63	350	184	7	
125	12R1248	1	24	3,2	255	73	69	458	226	9	
160	12R1648	1	24	4,0	255	83	82	491	226	9	

Stainless steel flap AISI 304 Lip Ring



**TYPE 1**

**Single Socket - RRJ - All plastic smooth materials ØOD**  
**Clapet anti-retour en PVC injecté M/F à joint, 1 clapet**  
**Válvula anti-retorno M/H con junta labiada, clapeta única**

DN (mm)	Reference Black			S (mm)	L (mm)	L1 (mm)	L2 (mm)	L3 (mm)	L4 (mm)	Offset (mm)	Note
100	11R1048	1	60	3,0	171	60	57	338	184	7	
110	11R1148	1	60	3,2	171	65	63	350	184	7	
125	11R1248	1	24	3,2	255	73	69	458	226	9	
160	11R1648	1	24	4,0	255	83	82	491	226	9	

Stainless steel flap AISI 304 Lip Ring





*Lip seal version, we recommend to lubricate the gasket to make installation easier*

**SOLVENT CEMENT transition fitting**

 **TYPE 2**
**Single Socket - SCJ - PVC**

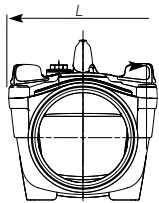
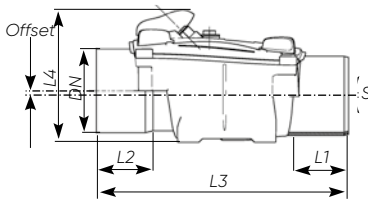

Clapet anti-retour en PVC injecté M/F à coller, 2 clapets  
Válvula anti-retorno M/H para encolar, clapeta doble

DN (mm)	Reference Black			S (mm)	L (mm)	L1 (mm)	L2 (mm)	L3 (mm)	L4 (mm)	Offset (mm)	Note
100	12S1008	1	60	3,0	171	60	53	334	184	7	
110	12S1108	1	60	3,2	171	65	63	350	184	7	
125	12S1208	1	24	3,2	255	73	69	458	226	9	
160	12S1608	1	24	4,0	255	83	82	491	226	9	

 Stainless steel flap AISI 304 

 **TYPE 1**
**Single Socket - SCJ - PVC**

Clapet anti-retour en PVC injecté M/F à coller, 1 clapet  
Válvula anti-retorno M/H para encolar, clapeta única

DN (mm)	Reference Black			S (mm)	L (mm)	L1 (mm)	L2 (mm)	L3 (mm)	L4 (mm)	Offset (mm)	Note
100	11S1008	1	60	3,0	171	60	53	334	184	7	
110	11S1108	1	60	3,2	171	65	63	350	184	7	
125	11S1208	1	24	3,2	255	73	69	458	226	9	
160	11S1608	1	24	4,0	255	83	82	491	226	9	

 Stainless steel flap AISI 304 

**Solvent cement - Colle - Adhesivo**

Pack	Gr.	Reference
Tube	125	COLLA12
Jar	250	COLLA25
Jar	500	COLLA50
Jar	1.000	COLLA00

\* See Accessories and special solutions

**TYPE 2**



**Spigot/Spigot - All materials/PVC (Recommended for renovation)**

**Clapet anti-retour en PVC injecté M/M - 2 clapets**

**Válvula anti-retorno M/M clapeta doble (recomendada para obras de renovación)**

DN (mm)	Reference Black			S (mm)	L (mm)	L1 (mm)	L2 (mm)	L3 (mm)	L4 (mm)	Offset (mm)	Note
100	12M10M8	1	60	3,0	171	60	60	355	184	7	
110	12M11M8	1	60	3,2	171	65	65	365	184	7	
125	12M12M8	1	24	3,2	255	73	73	455	226	9	
160	12M16M8	1	24	4,0	255	83	83	468	226	9	

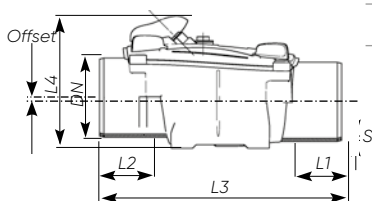

Stainless steel flap AISI 304 **CE**



**TYPE 1**

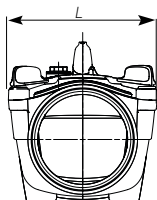

**Spigot/Spigot - All materials/PVC (Recommended for renovation)**

**Clapet anti-retour en PVC injecté M/M - 1 clapet**

**Válvula anti-retorno M/M clapeta única (recomendada para obras de renovación)**

DN (mm)	Reference Black			S (mm)	L (mm)	L1 (mm)	L2 (mm)	L3 (mm)	L4 (mm)	Offset (mm)	Note
100	11M10M8	1	60	3,0	171	60	60	355	184	7	
110	11M11M8	1	60	3,2	171	65	65	365	184	7	
125	11M12M8	1	24	3,2	255	73	73	455	226	9	
160	11M16M8	1	24	4,0	255	83	83	468	226	9	

Stainless steel flap AISI 304 **CE**



Example of installation



Installation with non-plastic materials



Push-fit installation (plastic only)



**TYPE 1**

**Non-return valve**

**Clapet anti-retour - Válvula anti-retorno**

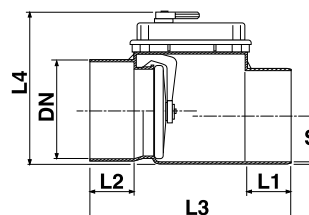
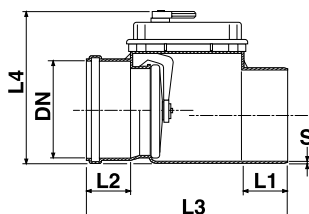

DN (mm)	S (mm)	L1 (mm)	L2 (mm)	L3 (mm)	L4 (mm)	Reference RAL 8023 Red			Note
100	4.0	58	56	300	230	1555052*	1	56	With Lip-ring
110	4.0	61	61	307	230	1555551	1	56	With Lip-ring
125	4.0	68	65	318	230	1556051	1	56	With Lip-ring
160	4.0	74	74	337	255	1551691	1	30	With Lip-ring
200	4.5	100	86	451	300	1552091	1	24	With Lip-ring

100	4.0	58	56	300	230	1555001	1	56	Solvent cement socket
110	4.0	61	61	307	230	1555501	1	56	Solvent cement socket
125	4.0	68	65	318	230	1556001	1	56	Solvent cement socket
140	4.0	69	65	325	255	1551401	1	30	Solvent cement socket
160	4.0	74	74	337	255	1551601	1	30	Solvent cement socket
200	4.5	100	86	451	300	1552001	1	24	Solvent cement socket

\* Grey colour Lip Ring



**TYPE 1**

**Non-return valve stainless steel flap**

**Clapet anti-retour - Válvula anti-retorno con clapeta de acero inox**



Stainless steel flap  
AISI 304

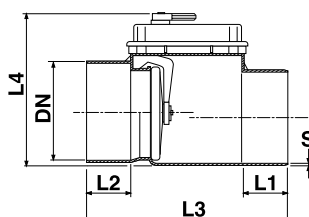
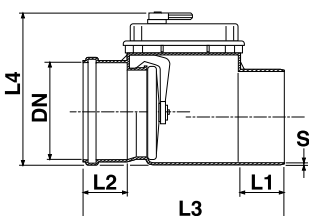

DN (mm)	S (mm)	L1 (mm)	L2 (mm)	L3 (mm)	L4 (mm)	Reference RAL 8023 Red			Note
110	4.0	61	61	307	230	1555651	1	56	With Lip-ring
125	4.0	68	65	318	230	1556151	1	56	With Lip-ring
160	4.0	74	74	337	255	1551791	1	30	With Lip-ring

100	4.0	61	57	300	230	1555101	1	56	Solvent cement socket
110	4.0	61	61	307	230	1555601	1	56	Solvent cement socket
125	4.0	68	65	318	230	1556101	1	56	Solvent cement socket
140	4.0	69	65	325	255	1551501	1	30	Solvent cement socket
160	4.0	74	74	337	255	1551701	1	30	Solvent cement socket

Stainless steel flap AISI 304 Lip Ring

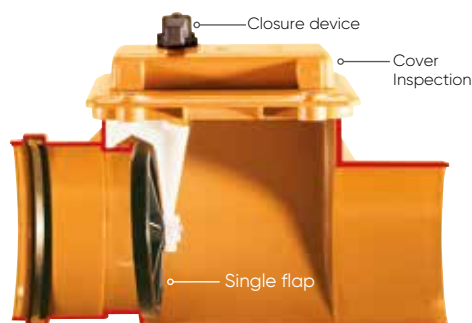



**Non-return valve**  
**Clapet anti-retour - Válvula anti-retorno**

DN (mm)	S (mm)	L1 (mm)	L2 (mm)	L3 (mm)	L4 (mm)	Reference RAL 8023 Red			Note
250	6.2	130	102	520	374	1552591	1	12	With Lip-ring
315	7.7	160	125	615	440	1553091	1	8	With Lip-ring

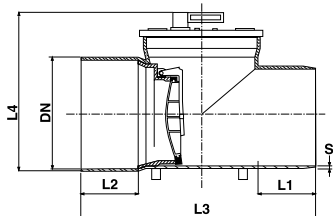
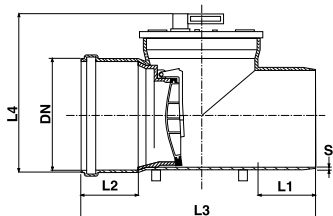

250	6.2	130	102	520	374	1552501	1	12	Solvent cement socket
315	7.7	160	125	615	440	1553001	1	8	Solvent cement socket

Lip Ring **DOP** available



**Non-return valve without emergency closure device**  
**Clapet anti-retour sans levier de verouillage**  
**Válvula anti-retorno sin palanca de cierre**

DN (mm)	S (mm)	L1 (mm)	L2 (mm)	L3 (mm)	L4 (mm)	Reference RAL 8023 Red			Note
400	9.8	245	140	800	480	1554091	1	4	With Lip-ring

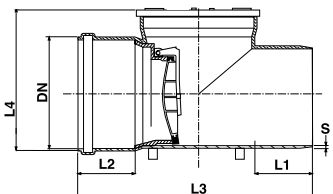

Lip Ring **DOP** available



**Non-return valve senza leva di blocco**

**Clapet anti-retour without emergency closure device**

**Válvula anti-retorno sin palanca de cierre**

DN (mm)	H (mm)	L1 (mm)	L2 (mm)	L3 (mm)	Reference RAL 8023 Red + black	SN			Note
500	645	1100	460	260	T555191	SN4*	1	1	With Lip-ring
630	775	1300	460	260	T556391	SN4*	1	1	With Lip-ring

\* the article is fabricated by using PVC pipe SN4 conform to EN1401

Male/Male version available on request

Lip Ring

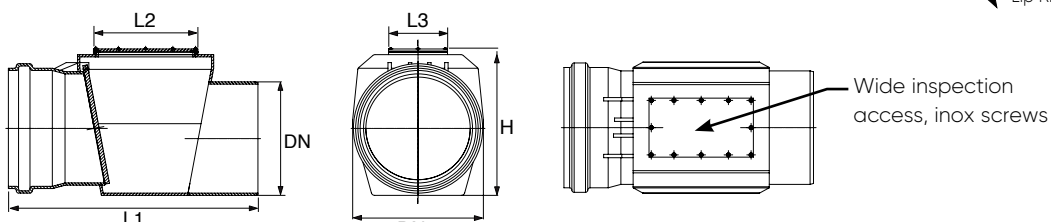

**TYPE O**

**Non-return valve without emergency closure device**

**Clapet anti-retour - Válvula anti-retorno**



DN (mm)	L3 (mm)	L4 (mm)	CN1 (mm)	L3S (mm)	Reference RAL 8023 Red			Riser	Note
110	280	170	154	20	NC879E1	1	90	PVC pipe Ø160 SN2 EN1401	Plastic flap
125	290	170	154	20	NC887E1	1	90	PVC pipe Ø160 SN2 EN1401	Plastic flap
160	396	257	236	25	NC919E1	1	24	PVC pipe Ø200 SN2 EN1401	Plastic flap

Lip Ring

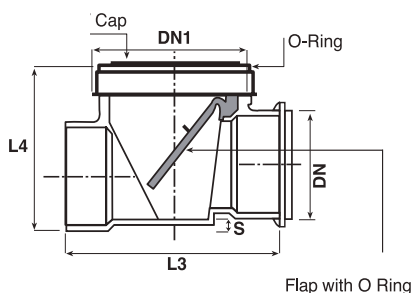

O'RING GASKET guarantees an hermetic seal



Type "O" cap with spirit level for a correct installation.

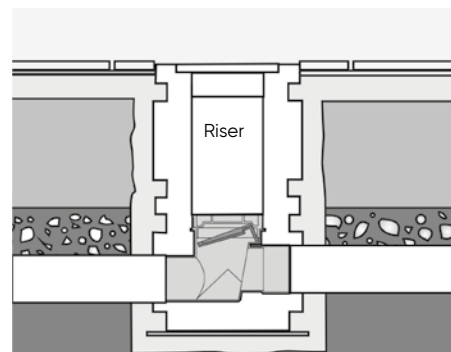



3.1 NON RETURN VALVES

## Spare parts - Pièces de rechang - Repuestos



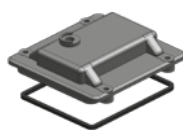

### Valve flap Clapet - Clapeta

DN (mm)	Reference			Note
100	1572206	1	-	PVC
110	1572206	1	-	PVC
125	1572206	1	-	PVC
100	15722IX	1	-	INOX
110	15722IX	1	-	INOX
125	15722IX	1	-	INOX
140	1573306	1	-	PVC
140	15722IX	1	-	INOX
160	1573306	1	-	PVC
160	15716IX	1	-	INOX
200	1574406	1	-	PVC
250	1574406	1	-	PVC
315	1576606	1	-	PVC
400	1577708	1	-	PVC





### Inspection cover Couverture - Tapa

DN (mm)	Reference			Note
100	1562201	1	-	
110	1562201	1	-	
125	1562201	1	-	
140	1563301	1	-	
160	1563301	1	-	
200	1564401	1	-	
250	1565501	1	-	
315	1566601	1	-	
400	16530T1	1	-	





### Locking lever Levier - Maneta



DN (mm)	Reference			Note
100	1582208	1	-	
110	1582208	1	-	
125	1582208	1	-	
140	1583308	1	-	
160	1583308	1	-	
200	1582208	1	-	
250	1585501	1	-	
315	1585501	1	-	



### Flap + support Kit clapet - Kit clapeta



DN (mm)	Reference			Note
100-110	1SP1100	1	-	
125-160	1SP1600	1	-	

### Kit with locking levers Kit de levier de verouillage Maneta + 4 bloqueos

Reference			Note
1KLMA00	1	-	



### Inspection cover with lever Couverture avec levier Tapa registro con bloqueo

DN (mm)	Reference			Note
100-110	1CO1100	1	-	
125-160	1CO1600	1	-	

## FLAP VALVE



Type A INOX FLAP

The flap valves allow the waste water to flow out from a pipe to either a ditch or a pond, preventing back flooding at the same time. The flap is opened by waste water's thrust. Flap's weight and 11° slant keep the device closed when not working.

- Material: PVC-U complying to EN1401.

- Colour: Red RAL 8023 (body) Grey (flap).
- Flap seal, EPDM + CR closed cell expanded rubber.
- Hinge: stainless steel AISI 304 with self locking nut.
- Flap closure tilt 11°.
- Up Ø 200 supplied in carton box.

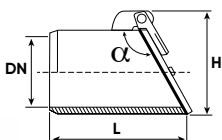
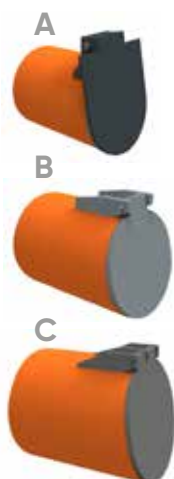

### Flap valve male Clapet de nez - Válvula de clapeta macho

DN (mm)	Ref.			L (mm)	H (mm)	α	Type	RAL Body	Flap
110	P5510M1	1	175	145	140	11°	A	RAL 8023	INOX
125	P5512M1	1	100	165	155	11°	A	RAL 8023	INOX
160	P5516M1	1	100	180	190	11°	A	RAL 8023	INOX
200	P5520M1	1	48	205	230	11°	A	RAL 8023	INOX
250	P5525M1	1	24	260	280	11°	B	RAL 8023	
315	P5530M1	1	8	300	350	11°	B	RAL 8023	
400	P5540M1	1	8	350	430	11°	C	RAL 8023	
500	P5550M1	1	4	400	530	11°	C	RAL 8023	
630	P5563M1	1	-	500	660	11°	C	RAL 8023	

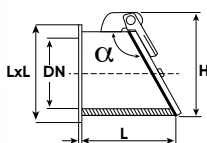
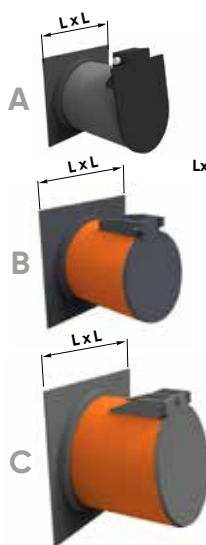

### Flap valve, flange Clapet de nez - Válvula de clapeta brida

DN (mm)	LxL (mm)	Ref.			L (mm)	H (mm)	S (mm)	α	Type	RAL Body	Flap
110	160	P551002	1	175	145	140	5	11°	A	RAL 7037	INOX
125	160	P551202	1	100	165	155	5	11°	A	RAL 7037	INOX
160	199	P551602	1	96	180	190	5	11°	A	RAL 7037	INOX
200	250	P552002	1	36	205	230	5	11°	A	RAL 7037	INOX
250	320	P552501	1	24	260	280	5	11°	B	RAL 8023	
315	370	P553001	1	18	300	350	6	11°	B	RAL 8023	
400	480	P554001	1	1	350	430	8	11°	C	RAL 8023	
500	600	P555001	1	10	400	530	10	11°	C	RAL 8023	
630	730	P556301	1	-	500	660	12	11°	C	RAL 8023	

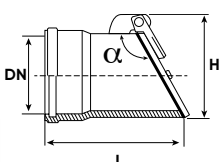
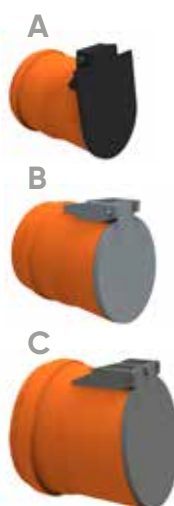



### Flap valve, soket Clapet de nez - Válvula de clapeta hembra

DN (mm)	Ref.			L (mm)	H (mm)	α	Type	RAL Body	Flap
110	P5510F1	1	175	145	140	11°	A	RAL 8023	INOX
125	P5512F1	1	100	165	155	11°	A	RAL 8023	INOX
160	P5516F1	1	100	180	190	11°	A	RAL 8023	INOX
200	P5520F1	1	48	205	230	11°	A	RAL 8023	INOX
250	P5525F1	1	12	260	280	11°	B	RAL 8023	
315	P5530F1	1	20	300	350	11°	B	RAL 8023	
400	P5540F1	1	-	350	430	11°	C	RAL 8023	
500	P5550F1	1	2	400	530	11°	C	RAL 8023	
630	P5563F1	1	-	500	660	11°	C	RAL 8023	

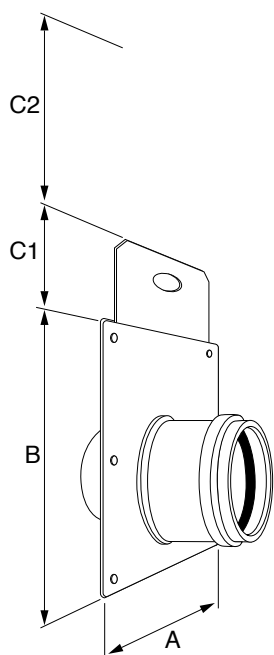
## Non-return valves



### Guillotine valve Clapet guillotine - Válvula de guillotina

DN (mm)	Reference			A (mm)	B (mm)	C1 (mm)	C2 (mm)	Note
110	P5510G1	1	-	172	300	74	110	
125	P5512G1	1	-	194	311	82	142	
160	P5516G1	1	-	225	335	95	180	
200	P5520G1	1	-	264	374	100	219	
250	P5525G1	1	-	330	430	110	250	
315	P5530G1	1	-	425	540	115	340	
400	P5540G1	1	-	510	583	110	450	
500	P5550G1	1	-	-	-	-	-	on request

Material: PVC-U

