



INDICATIVE PRODUCT IMAGE

Product file

Code	RCS3250608ED
Range	RCS
Model	Cubic
Application	LBP
PED	0
Rows number	6
Total surface	16.7 m ²
Defrosting (Watt)	1950 W
Net weight	30.3 kg
Inlet connection	12 mm-1/2" sae
Outlet connection	22 mm
Drain connection	1" Gas (33mm)
Fin spacing	8
Circuit volume	6.92 dm ³

Fan-motor

Type	Shielded poles
Fan-motors no.	3
Diameter	254 mm
Power supply	230/1/50-60
High speed	1300 rpm
Power consumption	240 W
Current consumption	1.05 A
Air flow	2622 m ³ /h
Air throw	13 m

Technical data - RCS3250608ED

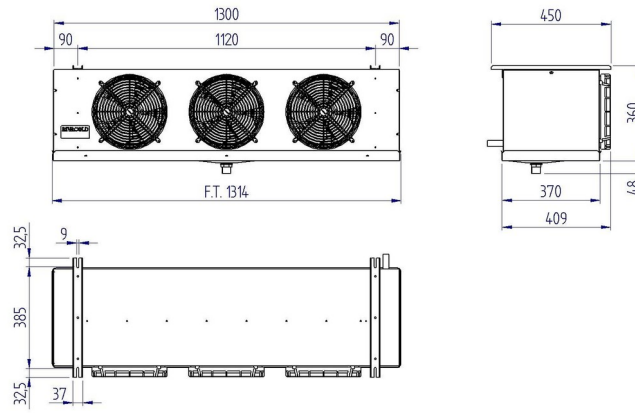

Refrigerating capacity table (W) - RCS3250608ED

High speed - RCS3250608ED

$\Delta T \setminus$ Cold room Temp	-40 °C	-35 °C	-30 °C	-25 °C	-20 °C	-15 °C	-10 °C	-5 °C	0 °C	2 °C	4 °C
5 K	1518	1650	1782	1903	2013	2123	2244	2387	2574	2607	2640
6 K	1738	1958	2178	2321	2475	2607	2761	2926	3135	3146	3168
7 K	1958	2233	2508	2739	2904	3080	3267	3454	3685	3707	3729
8 K	2145	2475	2805	3102	3322	3542	3762	3993	4257	4301	4334
9 K	2277	2673	3069	3432	3740	3971	4235	4499	4807	4862	4917
10 K	2475	2882	3289	3718	4092	4378	4686	4994	5335	5412	5478

Values referred to :
Gas R452A



INDICATIVE PRODUCT IMAGE

General features

- RCS range unit coolers have been designed to be installed inside cold rooms suited for fresh and frozen goods storage
- Their shape, being extremely compact, make their installation possible also in cold rooms having very small dimensions
- RCS range is available in different combinations of fin spacing dimensions and tube rows properly sized according to the needed applications.
- The ED version is supplied with mounted defrosting heaters and is suitable for being used at low temperature applications.
- The fan motors operate in the suction mode and prevent the condensate forming on the fan
- The coil is made of aluminium fins, 12 mm copper tube and a geometry of 37,5 x 32,5
- RCS unit coolers can be classified in three groups according to the needed cold room temperature (Tc): 4mm fin spacing for a Tc from -5°C to +15°C; 6mm fin spacing for a Tc from -20°C to +15°C; 8mm fin spacing for a Tc from -40°C to +4°C
- Each fin spacing group is also available with 4 and 6 rows.
- The coils are tested with nitrogen at a pressure of 25 bar.
- The fan motor models in use have the following features:
 - Manufactured following EN 60335-1 laws, with internal thermal protection
 - Fan diameter 250mm
 - Power supply 230-240V/1/50-60Hz
 - IP44 protection rate
 - F insulation class
 - Operating temperature from -40°C to +40°C
 - Electrics made in conformity with 2006/95/CE Low Tension directive
- The housing is made of aluminium
- The manufacturing solutions used give the housing strength and guarantee the absence of vibrations during the functioning.
- Screws, washers and nuts are made of stainless steel