



INDICATIVE PRODUCT IMAGE

Product file

Code	RCS1250406ED
Range	RCS
Model	Cubic
Application	MBP
PED	0
Rows number	4
Total surface	4.9 m ²
Defrosting (Watt)	750 W
Net weight	13.9 kg
Inlet connection	12 mm-1/2" sae
Outlet connection	12 mm
Drain connection	1" Gas (33mm)
Fin spacing	6
Circuit volume	1.72 dm ³

Fan-motor

Type	Shielded poles
Fan-motors no.	1
Diameter	254 mm
Power supply	230/1/50-60
High speed	1300 rpm
Power consumption	80 W
Current consumption	0.35 A
Air flow	917 m ³ /h
Air throw	8 m

Technical data - RCS1250406ED

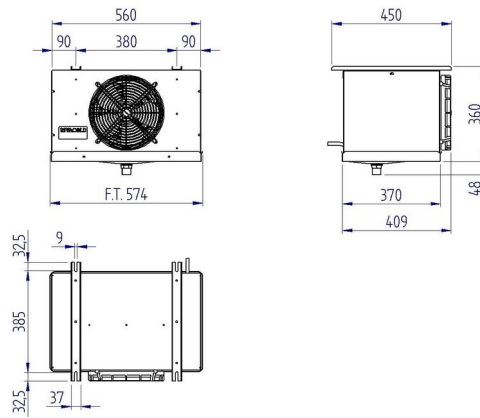

Refrigerating capacity table (W) - RCS1250406ED

High speed - RCS1250406ED

$\Delta T \setminus$ Cold room Temp	-20 °C	-15 °C	-10 °C	-5 °C	0 °C	2 °C	4 °C	6 °C	8 °C	10 °C	12 °C	15 °C
5 K	500 ⁽¹⁾	521	546	577	617	622	627	634	648	664	682	710
6 K	627 ⁽¹⁾	656	694	722	770	774	779	789	798	817	836	865
7 K	751 ⁽¹⁾	789	827	874	922	926	931	941	950	969	979	993
8 K	874 ⁽¹⁾	922	969	1026	1083	1093	1102	1112	1121	1131	1159	1202
9 K	988 ⁽¹⁾	1055	1112	1169	1235	1245	1254	1264	1283	1302	1321	1349
10 K	1093 ⁽¹⁾	1169	1235	1311	1387	1397	1406	1425	1435	1444	1482	1539

(1) Application outside the recommended range

Values referred to :
Gas R449A Mid



INDICATIVE PRODUCT IMAGE

General features

- RCS range unit coolers have been designed to be installed inside cold rooms suited for fresh and frozen goods storage
- Their shape, being extremely compact, make their installation possible also in cold rooms having very small dimensions
- RCS range is available in different combinations of fin spacing dimensions and tube rows properly sized according to the needed applications.
- The ED version is supplied with mounted defrosting heaters and is suitable for being used at low temperature applications.
- The fan motors operate in the suction mode and prevent the condensate forming on the fan
- The coil is made of aluminium fins, 12 mm copper tube and a geometry of 37,5 x 32,5
- RCS unit coolers can be classified in three groups according to the needed cold room temperature (Tc): 4mm fin spacing for a Tc from -5°C to +15°C; 6mm fin spacing for a Tc from -20°C to +15°C; 8mm fin spacing for a Tc from -40°C to +4°C
- Each fin spacing group is also available with 4 and 6 rows.
- The coils are tested with nitrogen at a pressure of 25 bar.
- The fan motor models in use have the following features:
 - Manufactured following EN 60335-1 laws, with internal thermal protection
 - Fan diameter 250mm
 - Power supply 230-240V/1/50-60Hz
 - IP44 protection rate
 - F insulation class
 - Operating temperature from -40°C to +40°C
 - Electrics made in conformity with 2006/95/CE Low Tension directive
- The housing is made of aluminium
- The manufacturing solutions used give the housing strength and guarantee the absence of vibrations during the functioning.
- Screws, washers and nuts are made of stainless steel