



INDICATIVE PRODUCT IMAGE

Product file

Code	RCS2250408ED
Range	RCS
Model	Cubic
Application	LBP
PED	0
Rows number	4
Total surface	7.4 m ²
Defrosting (Watt)	1350 W
Net weight	21.4 kg
Inlet connection	12 mm-1/2" sae
Outlet connection	16 mm
Drain connection	1" Gas (33mm)
Fin spacing	8
Circuit volume	3.16 dm ³

Fan-motor

Type	Shielded poles
Fan-motors no.	2
Diameter	254 mm
Power supply	230/1/50-60
High speed	1300 rpm
Power consumption	160 W
Current consumption	0.7 A
Air flow	1964 m ³ /h
Air throw	10 m

Technical data - RCS2250408ED

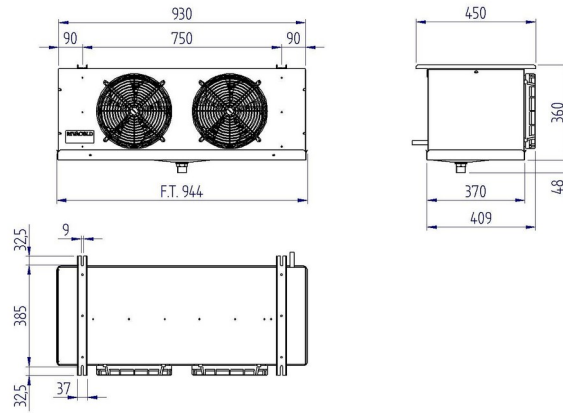

Refrigerating capacity table (W) - RCS2250408ED

High speed - RCS2250408ED

$\Delta T \setminus$ Cold room Temp	-40 °C	-35 °C	-30 °C	-25 °C	-20 °C	-15 °C	-10 °C	-5 °C	0 °C	2 °C	4 °C
5 K	866	913	960	994	1032	1068	1111	1177	1254	1260	1265
6 K	1067	1133	1199	1265	1309	1353	1408	1474	1562	1573	1584
7 K	1276	1353	1430	1518	1584	1639	1705	1782	1870	1881	1892
8 K	1408	1540	1672	1760	1848	1925	2002	2090	2200	2211	2222
9 K	1540	1705	1870	2013	2101	2200	2299	2398	2519	2530	2541
10 K	1661	1859	2057	2233	2343	2475	2585	2695	2838	2860	2871

Values referred to :
Gas R452A



INDICATIVE PRODUCT IMAGE

General features

- RCS range unit coolers have been designed to be installed inside cold rooms suited for fresh and frozen goods storage
- Their shape, being extremely compact, make their installation possible also in cold rooms having very small dimensions
- RCS range is available in different combinations of fin spacing dimensions and tube rows properly sized according to the needed applications.
- The ED version is supplied with mounted defrosting heaters and is suitable for being used at low temperature applications.
- The fan motors operate in the suction mode and prevent the condensate forming on the fan
- The coil is made of aluminium fins, 12 mm copper tube and a geometry of 37,5 x 32,5
- RCS unit coolers can be classified in three groups according to the needed cold room temperature (Tc): 4mm fin spacing for a Tc from -5°C to +15°C; 6mm fin spacing for a Tc from -20°C to +15°C; 8mm fin spacing for a Tc from -40°C to +4°C
- Each fin spacing group is also available with 4 and 6 rows.
- The coils are tested with nitrogen at a pressure of 25 bar.
- The fan motor models in use have the following features:
 - Manufactured following EN 60335-1 laws, with internal thermal protection
 - Fan diameter 250mm
 - Power supply 230-240V/1/50-60Hz
 - IP44 protection rate
 - F insulation class
 - Operating temperature from -40°C to +40°C
 - Electrics made in conformity with 2006/95/CE Low Tension directive
- The housing is made of aluminium
- The manufacturing solutions used give the housing strength and guarantee the absence of vibrations during the functioning.
- Screws, washers and nuts are made of stainless steel