

EX-EMVS 50

Ex-stop end, brass, with mounted o-ring

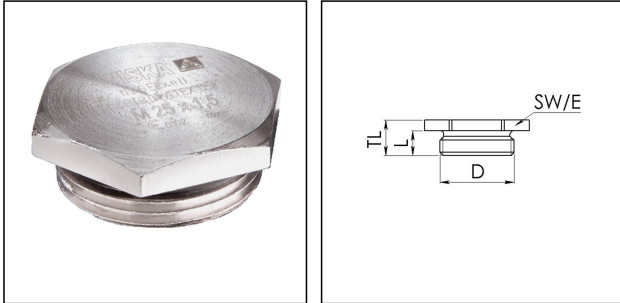

Product illustrations are exemplary and may differ from the chosen product. Further variants and individual customization, we will gladly provide you on request.



Material	Brass nickel-plated
Material sealing gasket	EPDM
Temp. range min	-40 °C
Temp. range max	120 °C
Protection class	IP 68
Marking	II 2 G Ex e IIC Gb, II 2 D Ex tb IIIC Db
Approval	PTB 05 ATEX 1106, IECEx PTB 14.0024
Thread type	M
Connection thread size D	50
Lead	1,5
Length screw-in thread L	9 mm
Key width SW	54 mm
Collar diameter (E)	62 mm
Total length TL	15 mm
Surface	Nickel-plated
Order no. nickel-plated	10065337
Type	EX-EMVS 50
Packing unit	1
ETIM-Classification	EC000032

Recommended accessories

EMMU 50	10063147
----------------	----------

06.08.2015

