

EMSKV-L 25 LT

Cable gland LowTemp, brass with long thread

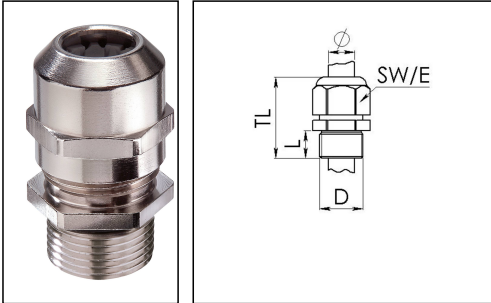

Product illustrations are exemplary and may differ from the chosen product. Further variants and individual customization, we will gladly provide you on request.



Material cable gland	Brass nickel-plated
Material clamping cage	Polyamide
Material sealing gasket	Silicone
Temp. range min	-60 °C
Temp. range max	100 °C
Intermittent temp. range	120 °C
Protection class	IP 69K, IP 68, 5 bar 30 min
Thread type	M
Connection thread size D	25
Lead	1,5
Length screw-in thread L	12 mm
Cable diameter min	9 mm
Cable diameter max	17 mm
Key width SW	29 mm
Collar diameter (E)	32 mm
Total length TL	38 mm - 47 mm
Type of cable anchorage	A
Install. torques cap nut	15 N m
Impact category	6
Surface	Nickel-plated
Order no. nickel-plated	10065811
Packing unit	50
Type	EMSKV-L 25 LT
ETIM-Classification	EC000441

Recommended accessories

RDE 25 LT

10063910

06.08.2015

