

EMSKV 40 LT

Cable gland LowTemp, brass with short thread

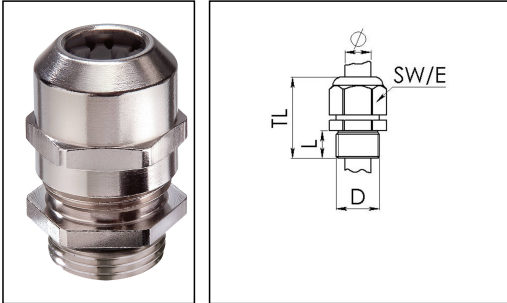

Product illustrations are exemplary and may differ from the chosen product. Further variants and individual customization, we will gladly provide you on request.



Material cable gland	Brass nickel-plated
Material clamping cage	Polyamide
Material sealing gasket	Silicone
Temp. range min	-60 °C
Temp. range max	100 °C
Intermittent temp. range	120 °C
Protection class	IP 69K, IP 68, 5 bar 30 min
Thread type	M
Connection thread size D	40
Lead	1,5
Length screw-in thread L	8 mm
Cable diameter min	16 mm
Cable diameter max	28 mm
Key width SW	46 mm
Collar diameter (E)	51 mm
Total length TL	44 mm - 55 mm
Type of cable anchorage	A
Install. torques cap nut	25 N m
Impact category	6
Surface	Nickel-plated
Order no. nickel-plated	10065805
Packing unit	10
Type	EMSKV 40 LT
ETIM-Classification	EC000441

Recommended accessories

EMMU 40	10063146
RDE 40 LT	10063960

06.08.2015

