

## EMSKV 25 LT

Cable gland LowTemp, brass with short thread

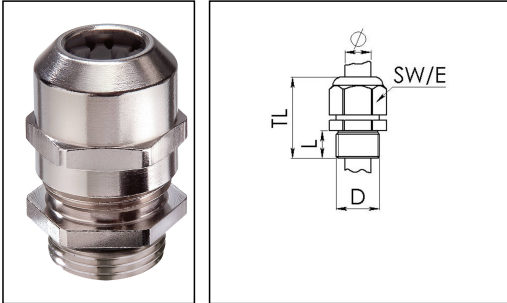

Product illustrations are exemplary and may differ from the chosen product. Further variants and individual customization, we will gladly provide you on request.



Material cable gland	Brass nickel-plated
Material clamping cage	Polyamide
Material sealing gasket	Silicone
Temp. range min	-60 °C
Temp. range max	100 °C
Intermittent temp. range	120 °C
Protection class	IP 69K, IP 68, 5 bar 30 min
Thread type	M
Connection thread size D	25
Lead	1,5
Length screw-in thread L	7 mm
Cable diameter min	9 mm
Cable diameter max	17 mm
Key width SW	29 mm
Collar diameter (E)	32 mm
Total length TL	33 mm - 42 mm
Type of cable anchorage	A
Install. torques cap nut	15 N m
Impact category	6
Surface	Nickel-plated
Order no. nickel-plated	10065803
Packing unit	50
Type	EMSKV 25 LT
ETIM-Classification	EC000441

Recommended accessories

<b>EMMU 25</b>	10063144
<b>RDE 25 LT</b>	10063910

06.08.2015

