

ESKV 25 LT

Cable gland LowTemp, polyamide with short thread

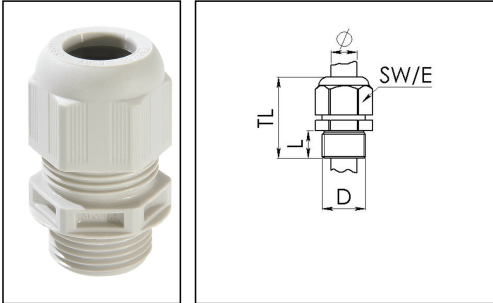

Product illustrations are exemplary and may differ from the chosen product. Further variants and individual customization, we will gladly provide you on request.



Material cable gland	Polyamide
Material sealing gasket	Silicone
Protection class	IP 69K, IP 68, 5 bar 30 min
Temp. range min	-60 °C
Temp. range max	100 °C
Intermittent temp. range	120 °C
Glow wire test	750 °C
Thread type	M
Connection thread size D	25
Lead	1,5
Length screw-in thread L	10 mm
Cable diameter min	9 mm
Cable diameter max	17 mm
Key width SW	29 mm
Collar diameter (E)	32 mm
Total length TL	38 mm - 47 mm
Type of cable anchorage	A
Install. torques fitting	10 N m
Impact category	4
Install. torques cap nut	4 N m
Product Color	RAL 7035
Type	ESKV 25 LT
Order no. RAL 7035	10062779
Packing unit	50
ETIM-Classification	EC000441

Recommended accessories

RDE 25 LT	10063910
ORD-S 25	10101760

06.08.2015

