

## NMSKV 2

Cable gland, brass

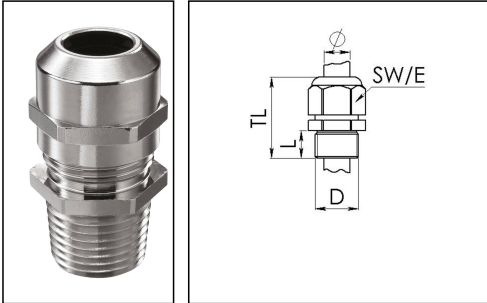

Product illustrations are exemplary and may differ from the chosen product. Further variants and individual customization, we will gladly provide you on request.



Material cable gland	Brass nickel-plated
Material clamping cage	Polyamide
Material sealing gasket	EPDM
Temp. range min	-40 °C
Temp. range max	100 °C
Intermittent temp. range	120 °C
Protection class	IP 68, 5 bar 30 min, IP 69K
Thread type	NPT
Connection thread size D	2"
Length screw-in thread L	21 mm
Cable diameter min	34 mm
Cable diameter max	48 mm
Cable Diameter UL	38,1 mm - 47,5 mm
Key width SW	68 mm
Collar diameter (E)	75 mm
Type of cable anchorage	A
Install. torques fitting	40 N m
Install. torques cap nut	40 N m
Impact category	6
Total length TL	56 mm - 67 mm
Surface	Nickel-plated
Order no. nickel-plated	10065487
Type	NMSKV 2
Packing unit	10
ETIM-Classification	EC000441

Recommended accessories

<b>RDE 63</b>	10062189
<b>BS 38</b>	10064018
<b>NMMU 2</b>	10100979
<b>MFD 63/01/131-01/118-03/084-02/064</b>	10101114
<b>MFD 63/03/065</b>	10101201
<b>MFD 63/02/065-01/090</b>	10101223

06.08.2015

