

NMSKV 1 1/4

Cable gland, brass

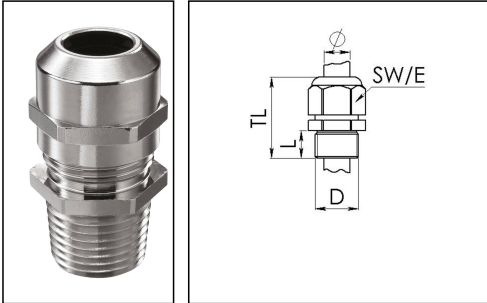

Product illustrations are exemplary and may differ from the chosen product. Further variants and individual customization, we will gladly provide you on request.



Material cable gland	Brass nickel-plated
Material clamping cage	Polyamide
Material sealing gasket	EPDM
Temp. range min	-40 °C
Temp. range max	100 °C
Intermittent temp. range	120 °C
Protection class	IP 68, 5 bar 30 min, IP 69K
Thread type	NPT
Connection thread size D	1 1/4"
Length screw-in thread L	20 mm
Cable diameter min	16 mm
Cable diameter max	28 mm
Cable Diameter UL	17,4 mm - 26,4 mm
Key width SW	46 mm
Collar diameter (E)	51 mm
Type of cable anchorage	A
Install. torques fitting	20 N m
Install. torques cap nut	20 N m
Impact category	6
Total length TL	50 mm - 58 mm
Surface	Nickel-plated
Order no. nickel-plated	10065485
Type	NMSKV 1 1/4
Packing unit	10
ETIM-Classification	EC000441

Recommended accessories

RDE 40	10062187
BS 20	10064013
MFD 40/08/060	10064346
MFD 40/07/080	10064347
MFD 40/07/070	10064348
NMMU 1 1/4	10100977
MFD 40/04/100	10101017
MFD 40/09/069	10101427
MFD 40/03/125	10102054
MFD 40/06/065	10102171
MFD 40/06/090	10102172

06.08.2015

