

NSKV 3/8

Cable gland, polyamide

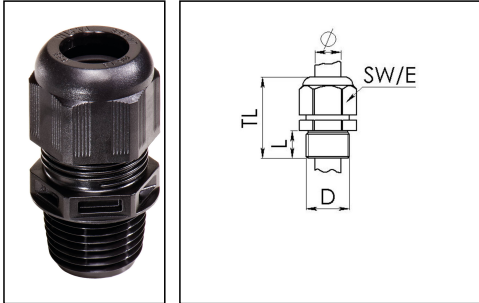

Product illustrations are exemplary and may differ from the chosen product. Further variants and individual customization, we will gladly provide you on request.



Material cable gland	Polyamide
Material sealing gasket	EPDM
Temp. range min	-40 °C
Temp. range max	100 °C
Intermittent temp. range	120 °C
Protection class	IP 69K, IP 68, 5 bar 30 min
Thread type	NPT
Connection thread size D	3/8"
Length screw-in thread L	15 mm
Cable diameter min	4,5 mm
Cable diameter max	10 mm
Cable Diameter UL	6 mm - 8,6 mm
Key width SW	20 mm
Collar diameter (E)	22 mm
Total length TL	35 mm - 41 mm
Glow wire test	750 °C
Install. torques cap nut	1,5 N m
Type of cable anchorage	A
Install. torques fitting	3,5 N m
Impact category	2
Product Color	RAL 9005
Order no. RAL 9005	10061867
Type	NSKV 3/8
Packing unit	50
ETIM-Classification	EC000441

Recommended accessories

RDE 16	10062184
BS 6	10064004

06.08.2015

