

NSKV 2

Cable gland, polyamide

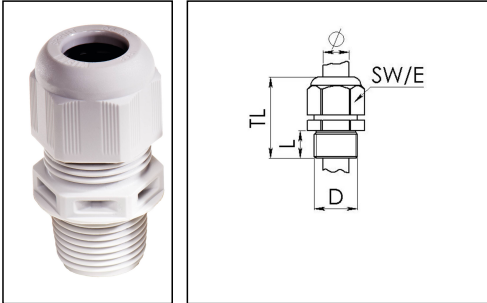

Product illustrations are exemplary and may differ from the chosen product. Further variants and individual customization, we will gladly provide you on request.



Material cable gland	Polyamide
Material sealing gasket	EPDM
Temp. range min	-40 °C
Temp. range max	100 °C
Intermittent temp. range	120 °C
Protection class	IP 69K, IP 68, 5 bar 30 min
Thread type	NPT
Connection thread size D	2"
Length screw-in thread L	18 mm
Cable diameter min	34 mm
Cable diameter max	48 mm
Cable Diameter UL	38,1 mm - 47,5 mm
Key width SW	68 mm
Collar diameter (E)	75 mm
Total length TL	69 mm - 83 mm
Glow wire test	750 °C
Install. torques cap nut	30 N m
Type of cable anchorage	A
Install. torques fitting	30 N m
Impact category	5
Product Color	RAL 7035
Order no. RAL 7035	10062736
Type	NSKV 2
Packing unit	3
ETIM-Classification	EC000441

Recommended accessories

RDE 63	10062189
BS 38	10064018

06.08.2015

