

NOTIFICATION OF TEST RESULTS

Issued to: WAGO Kontakttechnik GmbH & Co. KG
Hansastraße 27, 32423 Minden/Westfalen, Germany

For the product: terminal block for copper conductors

Trade name: WAGO

Type/Model: TOPJOB S 2006

Manufactured by: WAGO Kontakttechnik GmbH & Co. KG
Hansastraße 27, 32423 Minden/Westfalen, Germany

Ratings: 6 mm², 10 mm², max 57 A, max. 1000 Vac / 1500 Vdc, max. 12 kV

Additional information: This NTR replaces NTR NL-7653 issued on 6 December 2017, due to the fact that that 1000 Vac / 1500 Vdc (pollution degree 2) and factory locations are added.
See annex for factory locations

A sample of the product has been tested and found to be in conformity with the current HD/EN and equivalent national standard

EN 60947-7-1:2009, EN 60947-7-2:2009, EN 60947-7-3:2009

As shown in the Test Report

2256631.52, 2256631.53, 2221172.52, 2221172.53

This Notification of Test Results is the result of testing a sample of the product submitted, in accordance with the provisions of the relevant specific standard.

This Notification of Test Results has been established by a body, which participates in the CENELEC Certification Agreement (CCA) of 11th September 1973 as amended on 29th March 1983. Any other body participating in the CCA will take this Notification as a basis for granting a national mark of conformity or a national approval as specified in the CCA, as long as the standard referred to above is still in force in the country of that body.

Arnhem, 9 July 2021

Number: NTR NL 7877

DEKRA Certification B.V.



H.R.M. Barends
Certification Manager

© Integral publication of this attestation and adjoining reports is allowed

CCA

CENELEC CERTIFICATION AGREEMENT

ACCORD DE CERTIFICATION DU CENELEC

DEKRA Certification B.V. Meander 1051, 6825 MJ Arnhem P.O. Box 5185, 6802 ED Arnhem, The Netherlands
T +31 88 96 83000 F +31 88 96 83100 www.dekra-product-safety.com Company registration 09085396

Annex

Ref. no. NTR NL 7877
Page 1 of 6

CCA

**CENELEC CERTIFICATION AGREEMENT
ACCORD DE CERTIFICATION DU CELENEC**

Factory locations

Wago Elwag sp.z.o.o.
ul. Piekna 58 a
50-506, Wroclaw
Poland

Wago Elwag
Innowacyjna 2
55-330 Wroblowice
Poland

Wago Pvt. Ltd.
C-27, Sector-58, Phase III
201301 Noida Uttar Pradesh
India

Wago Electronic (Tianjin) Co. Ltd.
No. 5 Quanhui Road
Wu Qing Development Area
301700 Tianjin
China

WAGO Kontakttechnik GmbH & Co. KG
Hansastraße 27, 32423 Minden/Westfalen
Germany

WAGO Kontakttechnik GmbH & Co. KG, Werk Sondershausen
Waldstrasse 1, 99706, Sondershausen
Germany

WAGO Contact S.A.
Route de l'Industrie 19, CP 168, 1564, Domdidier
Switzerland

WAGO Kontakttechnik GmbH & Co. KG
Cammer Str. 17,
32423 Minden
Germany

CCA**CENELEC CERTIFICATION AGREEMENT****ACCORD DE CERTIFICATION DU CELENEC**

Product	: terminal blocks
Trade name(s)	: WAGO
Type(s)/model(s)	: TOPJOB S 2006
Material	: thermoplastic material
Rated connecting capacity	: 6 mm ² / 10 mm ² rigid and flexible
Connectable conductors	: 0,5 mm ² - 10 mm ² rigid and flexible
Method of mounting	: for mounting on top hat rail 35 mm
Rated current	: 41 A (6 mm ²) 57 A (10 mm ²)
Rated voltage	: 800 V (pollution degree 3) 1000 Vac / 1500 Vdc (pollution degree 2)
Rated impulse withstand voltage	: 8 kV
Type	: 2006 with suffixes -1201, -1202, -1203, -1204, -1205, -1206, -1208, -1209
Description	: 2 conductor through terminal block, with screwless-type terminals, 1-pole
Type	: 2006-1207
Description	: 2 conductor earth terminal block, with screwless-type terminals, 1-pole
Type	: 2006 with suffixes -1301, -1302, -1303, 1304, -1305, -1306, -1308, -1309
Description	: 3 conductor through terminal block, with screwless-type terminals, 1-pole
Type	: 2006-1307
Description	: 3 conductor earth terminal block, with screwless-type terminals, 1-pole
Current	: 41 A (6 mm ²) 51 A (10 mm ²)
Rated voltage	: 250 V (pollution degree 3)
Rated impulse withstand voltage	: 4 kV
Type	: 2006-7114
Description	: 1 conductor N-disconnect terminal block, with screwless terminals and 1 connection for busbar (10 x 3 mm), 1-pole
Type	: 2006-7111
Description	: 1 conductor power distribution disconnect terminal, with screwless terminals and 1 connection for busbar (10 x 3 mm), 1-pole

CCA**CENELEC CERTIFICATION AGREEMENT****ACCORD DE CERTIFICATION DU CELENEC**

Current : 30 A (6 mm²)
Rated voltage : 800 V (pollution degree 3)
Rated impulse withstand voltage : 8 kV
Type : 2006 with suffixes -1601, -1602, 1603, -1604
Description : 2 conductor through terminal block (permanently closed disconnect part), with screwless type terminals, 1-pole

Type : 2006 with suffixes -1661, -1662, -1663, -1664
Description : 2 conductor carrier terminal block, with screwless-type terminals, 1-pole

Current : 30 A (6 mm²)
Rated voltage : 800 V (pollution degree 3)
Rated impulse withstand voltage : 8 kV
Type : 2006 with suffixes -1671, -1672, -1673, -1674, -1675
Description : 2 conductor disconnect terminal block, with screwless type terminals, 1-pole

Type : optional suffixes for disconnect terminal blocks
.../400-0000

Description : disconnect knife rotated by 180°

Type : .../401-0000

Description : with mechanical locking element

Type : 2006-... with suffixes -1671, -1675 with additional suffixes
/1000-848 provided with LED 24 V
/1000-849 provided with LED 48 V
/1000-850 provided with neon light 120 V
/1000-851 provided with neon light 230 V
Description : ground conductor disconnect terminal block, with screwless type terminals, 2-poles

CCA**CENELEC CERTIFICATION AGREEMENT****ACCORD DE CERTIFICATION DU CELENEC**

Current	: 25 A (6 mm ²)
Rated voltage	: 500 V (pollution degree 3)
Rated impulse withstand voltage	: 8 kV (adjacent terminal block) 4 kV (internal)
Type	: 2006 with suffixes -1681, -1682, -1683, -1684
Description	: 2 conductor fuse terminal block for mini-automotive blade Style fuses, with screwless type terminals, 1-pole
Type	: 2006-1681 with suffixes /1000-429 with blown fuse indication 12 V, anode of LED on the right side /1000-449 with blown fuse indication 12 V, anode of LED on the left side /1000-413 with blown fuse indication 24 V, anode of LED on the right side /1000-434 with blown fuse indication 24 V, anode of LED on the left side /1000-414 with blown fuse indication 48 V, anode of LED on the right side /1000-435 with blown fuse indication 48 V, anode of LED on the left side
Current	: 10 A (6 mm ²)
Rated voltage	: 800 V (pollution degree 3)
Rated impulse withstand voltage	: 8 kV (adjacent terminal block) 6 kV (internal)
Type	: 2006 with suffixes -1611, -1612, -1613, - 1614, -1615 with optional suffixes / 1000-541; 12-30 V / 1000-542; 30-65 V / 1000-836; 230 V / 1000-859; 380-500 V / 1000-867; 120 V
Description	: 2 conductor fuse disconnect terminal block with pivoting fuseholder, with screwless type terminals, fuse size 5x20 mm, 1-pole exclusive short circuit protection: separate arrangement: PvK 2,5W compound arrangement: PvK 2,5W overload and short circuit protection: separate arrangement: Pv 2,5 W compound arrangement: Pv 1,6 W

CCA**CENELEC CERTIFICATION AGREEMENT****ACCORD DE CERTIFICATION DU CELENEC**

Type	: 2006 with suffixes -1621, -1622, -1623, 1624 with optional suffixes / 1000-541; 12-30 V / 1000-542; 30-65 V / 1000-836; 230 V / 1000-859; 380-500 V / 1000-867; 120 V
Description	: 2 conductor fuse disconnect terminal block with pivoting fuseholder, with screwless type terminals, fuse size 5x30 mm, 1-pole exclusive short circuit protection: separate arrangement: PvK 2,5W compound arrangement: PvK 2,5W overload and short circuit protection: separate arrangement: Pv 2,5 W compound arrangement: Pv 1,6 W
Current	: 10 A (6 mm ²)
Voltage	: 800 V (pollution degree 3)
Fuse size	: 5x30 mm
Type	: 2006 with suffixes -1631, -1632, -1633, -1634 additional suffixes / 0099-0000 / 1000-541; 12-30 V / 1000-542; 30-65 V / 1000-836; 230 V / 1000-859; 380-500 V / 1000-867; 120 V / 1099-541; 12-30 V / 1099-542; 30-65 V / 1099-836; 230 V / 1099-859; 380-500 V / 1099-867; 120 V
Description	: 2 conductor fuse disconnect terminal block with pivoting fuseholder, with screwless type terminals, fuse size 1/4 x 1 1/4, 1 pole exclusive short circuit protection: separate arrangement: PvK 2,5 W compound arrangement: PvK 2,5 W

CCA**CENELEC CERTIFICATION AGREEMENT****ACCORD DE CERTIFICATION DU CELENEC**

overload and short circuit protection
separate arrangement: Pv 2,5 W
compound arrangement: Pv 1,6 W

Current : 10 A (6 mm²)
Rated voltage : 800 V (pollution degree 3)
Fuse size : 1/4 x 1 1/4
Type : 2006-911 with suffixes
/1000-541 (12 V - 30 V)
/1000-542 (30 V - 65 V)
/1000-867 (120 V)
/1000-836 (230 V)
Description : fuse plug with pull tab suffixes provided with indicator light

Current : 10 A
Rated voltage : 800 V (pollution degree 3)
Fuse size : 5x30 mm
Type : 2006-921 with suffixes
/1000-541 (12 V - 30 V)
/1000-542 (30 V - 65 V)
/1000-867 (120 V)
/1000-836 (230 V)
/1000-859 (380 V - 500 V)
Description : fuse plug with pull tab provided with indicator light

Current : 30 A (6 mm²)
Rated voltage : 1000 Vac / 1500 Vdc (pollution degree 3)
Rated impulse withstand voltage : 12 kV

Type : 2006 with suffixes -8601, -8604
Description : 2 conductor through terminal block, with screwless type terminals, provided with disconnect part, which cannot be operated

Type : 2006 with suffixes -8664, -8661
Description : 2 conductor carrier terminal block, with screwless type terminals, 1 pole

Type : 2006 with suffixes -8671, -8674
Description : 2 conductor disconnect terminal block, with screwless type terminals, 1 pole





OD ECS 040-1
January 2019

Responsible CB



TEST REPORT SUMMARY

Report Number..... : **2256631.52**
Date of issue..... : **2021-07-06**
Tested by (name, function, signature): **W.C. van Ginkel**
 Technician Industrial Safety 
Witnessed by (name, function, signature):
Approved by (name, function, signature):
Supervised by (name, function, signature): **H.L. Schendstok**
 (Project Manager Industrial Safety) 

Testing Laboratory..... : **DEKRA Certification B.V.**
Address : **Meander 1051, 6825 MJ Arnhem, The Netherlands**
Testing procedure : ENEC CCA NTR
 ENEC based on IECCE CBTC with number:
Customer Testing Procedure..... : TMP/CTF Stage 1 WMT/CTF Stage 2 SMT/CTF Stage 3

Applicant : **WAGO Kontakttechnik GmbH & Co. KG**
Address : **Hansastraße 27, 32423 Minden/Westfalen, Germany**
Manufacturer : **WAGO Kontakttechnik GmbH & Co. KG**
Address : **Hansastraße 27, 32423 Minden/Westfalen, Germany**

Product..... : **Terminal blocks for copper conductors**
Model/Type reference : **TOPJOB S 2006**
Trademark : 
Ratings : **6 mm², 10 mm², max 57 A, max. 1000 Vac / 1500 Vdc, max. 12 kV**

Certification Scheme : ENEC CCA Other: _____
Standard(s)..... : **EN 60947-7-1: 2009, in conjunction with EN 60947-1: 2007 + A1:2012 + A2:2014**
 The text of the a.m. European Standard was approved by CENELEC is equivalent with the corresponding IEC Publication.
 The text of the a.m. European Standard was approved by CENELEC with agreed common modifications and is not equivalent with the corresponding IEC Publication. An EU Deviation Addendum has to be issued.

This EN test report consists of the following parts:
 IEC Test Report Number..... : **2256631.52**
 EU Deviation Addendum..... :

Copyright © 2019, ETICS Brussels, Belgium. All rights reserved.
This ECS document together with the test report is only valid if signed by an approved ENEC or CCA Testing Laboratory and accompanied by the associated ENEC Licence or CCA Notification of Test Results, issued by a Certification Body member of ECS.



Test Report issued under the responsibility of:



TEST REPORT
IEC 60947-7-1
Low-voltage switchgear and controlgear
Part 7: Ancillary equipment
Section One: Terminal blocks for copper conductors

Report Number..... : 2256631.52
Date of issue : 2021-07-06
Total number of pages..... 48

Name of Testing Laboratory preparing the Report..... : DEKRA Certification B.V.
Meander 1051, 6825 MJ Arnhem, The Netherlands

Applicant's name : WAGO Kontakttechnik GmbH & Co. KG
Address : HansasträÙe 27, 32423 Minden/Westfalen, Germany

Test specification:

Standard..... : IEC 60947-7-1:2009 (Third Edition) in conjunction with IEC 60947-1 (Fifth Edition) + A1:2012 + A2:2014
Test procedure..... : CB Scheme
Non-standard test method..... : N/A

Test Report Form No. : IEC60947_7_1B
Test Report Form(s) Originator : DEKRA Certification B.V.
Master TRF : Dated 2015-10

Copyright © 2015 IEC System of Conformity Assessment Schemes for Electrotechnical Equipment and Components (IECEE System). All rights reserved.

This publication may be reproduced in whole or in part for non-commercial purposes as long as the IECEE is acknowledged as copyright owner and source of the material. IECEE takes no responsibility for and will not assume liability for damages resulting from the reader's interpretation of the reproduced material due to its placement and context.

If this Test Report Form is used by non-IECEE members, the IECEE/IEC logo and the reference to the CB Scheme procedure shall be removed.

This report is not valid as a CB Test Report unless signed by an approved CB Testing Laboratory and appended to a CB Test Certificate issued by an NCB in accordance with IECEE 02.

General disclaimer:

The test results presented in this report relate only to the object tested.
This report shall not be reproduced, except in full, without the written approval of the Issuing CB Testing Laboratory. The authenticity of this Test Report and its contents can be verified by contacting the NCB, responsible for this Test Report.

Test item description..... :	terminal blocks for copper conductors
Trade Mark..... :	
Manufacturer..... :	WAGO Kontakttechnik GmbH & Co. KG
Model/Type reference..... :	TOPJOB S 2006
Ratings..... :	6 mm², 10 mm², max 57 A, max. 1000 Vac / 1500 Vdc, max. 12 kV

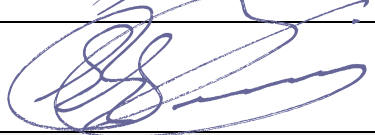
Responsible Testing Laboratory (as applicable), testing procedure and testing location(s):		
<input checked="" type="checkbox"/>	CB Testing Laboratory:	DEKRA Certification B.V.
Testing location/ address.....:		Meander 1051, 6825 MJ Arnhem, The Netherlands
<input type="checkbox"/>	Associated CB Testing Laboratory:	
Testing location/ address.....:		
Tested by (name, function, signature).....:		W.C. van Ginkel (Technician Industrial Safety) 
Approved by (name, function, signature)....:		H.L. Schendstok (Project Manager Industrial Safety) 
<input type="checkbox"/>	Testing procedure: CTF Stage 1:	
Testing location/ address.....:		
Tested by (name, function, signature).....:		
Approved by (name, function, signature)....:		
<input type="checkbox"/>	Testing procedure: CTF Stage 2:	
Testing location/ address.....:		
Tested by (name + signature)		
Witnessed by (name, function, signature)..:		
Approved by (name, function, signature)....:		
<input type="checkbox"/>	Testing procedure: CTF Stage 3:	
<input type="checkbox"/>	Testing procedure: CTF Stage 4:	
Testing location/ address.....:		
Tested by (name, function, signature).....:		
Witnessed by (name, function, signature)..:		
Approved by (name, function, signature)....:		
Supervised by (name, function, signature) :		

List of Attachments (including a total number of pages in each attachment): N/A	
Summary of testing:	
Tests performed (name of test and test clause):	Testing location:
<p>Project 2160584.70 Through terminal blocks: Complete examination</p> <p>All tests are carried out on 2006-1301 unless otherwise stated.</p> <p>Project 2166989.50 This test report replaces Test Report 2160854.70 issued on 6 March 2013, due to the fact that types are added.</p> <p>Project 2173612.50 This Test Report replaces test Report 2166989.50 issued on 5 February 2104, due to the fact that types are added.</p> <p>Project 2221172.50 This Test Report replaces test Report 2173612.50 issued on 15 October 2014, due to the fact that types are added, with other colours. No additional tests were necessary.</p> <p>Project 2256631.52 This Test report replaces Test Report 2221172.50 issued on 2017-11-28, due to the fact that the rated voltage of 1000 Vac / 1500 Vdc is added. The following tests are carried out on 2006-1306:</p> <ul style="list-style-type: none"> - Clauses 8.4.2 - Clause 8.4.3 <p>Further are added additional factory locations.</p>	<p>DEKRA Certification B.V. Meander 1051, 6825 MJ Arnhem The Netherlands</p>

Summary of compliance with National Differences (List of countries addressed): N/A

The product fulfils the requirements of EN 60947-7-1: 2009.

Copy of marking plate:

The artwork below may be only a draft. The use of certification marks on a product must be authorized by the respective NCBs that own these marks.

Example:

WAGO

WAGO TOP JOB S 2006

1000 V 6 mm² 30 A

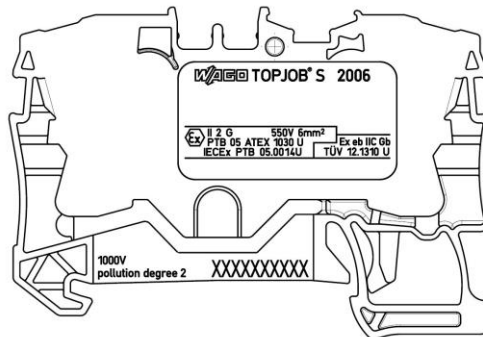

Test item particulars	
Classification of installation and use	
Supply Connection	
Particulars: test item vs. test requirements	
- method of fixing	mounting on top hat rail 35 mm
- number of poles	1 pole
- type of clamping units	screwless-type terminal
- ability to receive conductors	unprepared conductors, flexible or rigid
- number of terminals on terminal assembly	2 and 3
- rated cross-section (mm ²)	6 mm² (10 mm² for 57 A)
- rated connecting capacity (mm ²)	0,5 mm² - 10 mm² rigid and flexible
- rated insulation voltage (U_i)	250 V – 1000 Vac / 1500 Vdc (see page 44 - 46)
- rated impulse withstand voltage (U_{imp})	4 kV / 8 kV / 12 kV
- Conventional free air thermal current (I_{th})	30 A
Possible test case verdicts:	
- test case does not apply to the test object	N/A
- test object does meet the requirement	P (Pass)
- test object does not meet the requirement	F (Fail)
Testing	
Date of receipt of test item	2014-08 / 2021-05
Date (s) of performance of tests	2014-08 / 2021-05
General remarks:	
"(See Enclosure #)" refers to additional information appended to the report. "(See appended table)" refers to a table appended to the report.	
Throughout this report a <input checked="" type="checkbox"/> comma / <input type="checkbox"/> point is used as the decimal separator.	
Manufacturer's Declaration per sub-clause 4.2.5 of IEC 60947-1:	
The application for obtaining a CB Test Certificate includes more than one factory location and a declaration from the Manufacturer stating that the sample(s) submitted for evaluation is (are) representative of the products from each factory has been provided	<input checked="" type="checkbox"/> Yes <input type="checkbox"/> Not applicable
When differences exist; they shall be identified in the General product information section.	

Name and address of factory (ies)	<p>Wago Elwag sp.z.o.o. ul. Piekna 58 a 50-506, Wroclaw, Poland</p> <p>Wago Elwag Innowacyjna 2 55-330 Wroblowice, Poland</p> <p>Wago Pvt. Ltd. C-27, Sector-58, Phase III 201301 Noida Uttar Pradesh, India</p> <p>Wago Electronic (Tianjin) Co. Ltd. No. 5 Quanhui Road Wu Qing Development Area 301700 Tianjin, China</p> <p>WAGO Kontakttechnik GmbH & Co. KG Hansastraße 27, 32423 Minden/Westfalen Germany</p> <p>WAGO Kontakttechnik GmbH & Co. KG, Werk Sondershausen Waldstrasse 1, 99706, Sondershausen Germany</p> <p>WAGO Contact S.A. Route de l'Industrie 19, CP 168, 1564, Domdidier, Switzerland</p> <p>WAGO Kontakttechnik GmbH & Co. KG Cammer Str. 17, 32423 Minden Germany</p>
General product information:	See pages 44 to 49

IEC 60947-7-1			
Clause	Requirement – Test	Result - Remark	Verdict
5.1	MARKING		
	Terminal block shall be marked with:		
	- manufacturer's name or trademark		P
	- type designation	TOPJOB S 2006	P
5.2	The following information shall be stated by the manufacturer if applicable, e.g. in the manufacturer's data sheet, or his catalogue or on the packing unit:		
	- manufacturer's claim for compliance with IEC 60 947-7-1	IEC 60947-7-1 (catalogue)	P
	- rated cross-section	6 mm² or 10 mm² (catalogue)	P
	- rated connecting capacity	0,5 mm² - 10 mm² (catalogue)	P
	- rated insulation voltage (Ui)	250 V, 800 V, 1000 V (catalogue) (see page 46 - 48)	P
	- rated impulse withstand voltage (Uimp)	4 kV, 8 kV, 12 kV (catalogue)	P
	- conventional free air thermal current (Ith)	30 A (catalogue)	N
	- service conditions if different from those of Cl. 6.		N

7.	CONSTRUCTION		
7.1	Constructional requirements		
7.1.1	Clamping units		
7.1.7.1	All parts of clamping units which maintain contact and carry current shall be of metal having adequate mechanical strength		P
	Clamping units connections shall be such that necessary contact pressure is maintained		P
	Clamping units shall be so constructed that the conductor is clamped between suitable surfaces without damage to the conductor and terminal		P

IEC 60947-7-1			
Clause	Requirement – Test	Result - Remark	Verdict
	Clamping units shall not allow the conductor to be displaced or to be displaced themselves in a manner detrimental to the operation of equipment and the insulation voltage shall not be reduced below the rated value		P
	Clamping units shall allow the conductor to be connected by means ensuring that a reliable mechanical linkage and electrical contact is properly maintained		P
	Clamping units shall be able to withstand the forces that can be applied through the connected conductors		P
	Contact pressure is not transmitted through insulation materials		P
7.1.2	Mounting		
	Terminal blocks shall be provided with means that allow them to be securely attached to a rail or a mounting surface (see 8.3.2)		P
7.1.3	Clearances and creepage distances		
	For clearances and creepage distances see 8.4.2		
7.1.4	Terminal identification and marking:		
	- terminals intended exclusively for the neutral conductor		P
	- other terminals		
	- terminal blocks shall have provision, or at least space, for identification marks or numbers for each terminal or terminal assembly to be related to the circuit of which it is to form a part		P
	- For the identification of the terminal block the colour combination green-yellow is not allowed		P
7.1.5	Resistance to abnormal heat and fire		

IEC 60947-7-1			
Clause	Requirement – Test	Result - Remark	Verdict
	Needle flame test for insulation materials of terminal blocks (see 8.5)	5 s	P
7.1.6	Rated cross-section and rated connecting capacity		
	Terminal blocks are so designed that conductors of the rated cross-section and/or the rated connecting capacity can be accepted	0,5 mm² - 10 mm²	P
8	TESTS		
8.3	Verification of mechanical characteristics		
8.3.2	Attachment of the terminal block on its support (types 2006-1301, 2006-1601, 2006-8601)		
	mounting rail	top hat rail 35 mm	—
	Tightening torque (Nm)	-	—
	steel pin diameter (mm)	2,8 mm	—
	force (N)	5 N	—
	During the test, no terminal block shall work free from its rail or support, nor suffer any other damage		P
8.3.3	Mechanical properties of clamping units		
8.3.3.1	Test of mechanical strength of clamping units		
8.2.4.1	Mechanical strength of clamping units (IEC60947-1)		
	rated cross-section of a rigid conductor (mm ²) ...	6 mm²	—
	diameter of thread (mm)	-	—
	torque (Nm)	-	—
	5 times on 2 clamping units at the centre terminal block out of 5 terminal blocks	5 times inserted and removed	P
	Voltage drop before and after mechanical strength test		
	rated cross-section of a rigid conductor (mm ²) ...	6 mm²	—
	test current (A) d.c.	4,1 A	—
	voltage drop (mV) before mechanical strength test not exceeding 3,2 mV	1,89 mV – 2,11 mV	P

IEC 60947-7-1			
Clause	Requirement – Test	Result - Remark	Verdict
	If the measured value exceeds 3,2 mV, the voltage drop is determined on each individual clamping unit separately, which shall not exceed 1,6 mV		N
	voltage drop (mV) after mechanical strength test not exceeding 150% of the value measured before mechanical strength test :	1,97 mV – 2,05 mV	P
8.2.4.1	Mechanical strength of clamping units (IEC60947-1)		
	rated cross-section of a rigid conductor (mm ²) ... :	10 mm²	—
	diameter of thread (mm)	-	—
	torque (Nm)	-	—
	5 times on 2 clamping units at the centre terminal block out of 5 terminal blocks		P
	Voltage drop before and after mechanical strength test		
	rated cross-section of a rigid conductor (mm ²) ... :	10 mm²	—
	test current (A) d.c. :	5,7 A	—
	voltage drop (mV) before mechanical strength test not exceeding 3,2 mV	1,87 mV – 1,72 mV	P
	If the measured value exceeds 3,2 mV, the voltage drop is determined on each individual clamping unit separately, which shall not exceed 1,6 mV		N/A
	voltage drop (mV) after mechanical strength test not exceeding 150% of the value measured before mechanical strength test :	1,93 mV – 1,68 mV	P
	minimum cross-section of a flexible conductor (mm ²)	0,5 mm²	—
	test current (A) d.c. :	0,6 A	—
	voltage drop (mV) before mechanical strength test not exceeding 3,2 mV	1,32 mV – 1,24 mV	P
	If the measured value exceeds 3,2 mV, the voltage drop is determined on each individual clamping unit separately, which shall not exceed 1,6 mV		N/A

IEC 60947-7-1			
Clause	Requirement – Test	Result - Remark	Verdict
	voltage drop (mV) after mechanical strength test not exceeding 150% of the value measured before mechanical strength test	1,38 mV – 1,18 mV	P
8.3.3.2	Testing for damage to and accidental loosening of conductors of a terminal block (flexion test)		
	conductor of the smallest cross-section (mm ²) ... :	0,5 mm² rigid and flexible	—
	number of conductors of the smallest cross-section	1	—
	torque (Nm)	screwless	—
	diameter of bushing hole (mm)	6,5 mm	—
	height between the equipment and the platen (mm)	260 mm	—
	mass at the conductor(s) (kg)	0,3 kg	—
	135 continuous revolutions: the conductor shall neither slip out of the terminal nor break near the clamping unit		P
	Pull-out test		
	force (N)	30 N	—
	1 min, the conductor shall neither slip out of the terminal nor break near the clamping unit		
	conductor of the rated cross-section (mm ²)	6 mm² rigid and flexible	—
	number of conductors of the rated cross-section :	1	—
	torque (Nm)	screwless	—
	diameter of bushing hole (mm)	9,5 mm	—
	height between the equipment and the platen (mm)	280 mm	—
	mass at the conductor(s) (kg)	1,4 kg	—
	135 continuous revolutions: the conductor shall neither slip out of the terminal nor break near the clamping unit		P
	Pull-out test		
	force (N)	80 N	—

IEC 60947-7-1			
Clause	Requirement – Test	Result - Remark	Verdict
	1 min, the conductor shall neither slip out of the terminal nor break near the clamping unit		P
	conductor of the largest cross-section (mm ²) :	10 mm² rigid and flexible	—
	number of conductors of the largest cross-section :	1	—
	torque (Nm) :	screwless	—
	diameter of bushing hole (mm) :	9,5 mm	—
	height between the equipment and the platen (mm) :	280 mm	—
	mass at the conductor(s) (kg) :	2 kg	—
	135 continuous revolutions: the conductor shall neither slip out of the terminal nor break near the clamping unit		P
	Pull-out test		
	force (N) :	90 N	—
	1 min, the conductor shall neither slip out of the terminal nor break near the clamping unit		P
	conductor of the largest or smallest cross-section (mm ²) :		—
	number of conductors of the largest or smallest cross-section :		—
	torque (Nm) :		—
	diameter of bushing hole (mm) :		—
	height between the equipment and the platen (mm) :		—
	mass at the conductor(s) (kg) :		—
	135 continuous revolutions: the conductor shall neither slip out of the terminal nor break near the clamping unit		N/A
	Pull-out test		
	force (N) :		—

IEC 60947-7-1			
Clause	Requirement – Test	Result - Remark	Verdict
	1 min, the conductor shall neither slip out of the terminal nor break near the clamping unit		N/A
8.3.3.4	Verification of rated cross section and rated connecting capacity		
	One conductor of the two next smaller cross-sections can be unhindered and connected in each clamping unit of one terminal block (up to 35 mm ²)	2,5 mm²	P
8.4.2	Verification of clearances and creepage distances (type 2006-1306)		
	Conductor type and conductor cross-section	10 mm² rigid	—
	Conductor end length (mm)	13 - 15 mm	—
	Type of support	top hat rail 35 mm	—
8.4.2.2	Clearances		
	Case A mm)	8 mm	P
	Case B mm)	3 mm	
	Measured mm)	12,5 mm	
	Rated impulse withstand voltage U _{imp} (kV)	8 kV	P
8.4.2.3	Creepage distances:		
	- pollution degree	3	—
	- comparative tracking index (V)	600 V	—
	- material group	I	—
	- rated insulation voltage U _i (V)	800 V	—
	- minimum creepage distances (mm)	10 mm	—
	- measured creepage distances (mm)	> 14 mm	—
	- pollution degree	2	—
	- comparative tracking index (V)	600 V	—
	- material group	I	—
	- rated insulation voltage U _i (V)	1000 Vac / 1500 Vdc	—
	- minimum creepage distances (mm)	5 mm / 8 mm	—
	- measured creepage distances (mm)	> 14 mm	—
8.4.2	Verification of clearances and creepage distances (type 2006-7114)		
	Conductor type and conductor cross-section	10 mm² rigid	—

IEC 60947-7-1			
Clause	Requirement – Test	Result - Remark	Verdict
	Conductor end length (mm)	13 – 15 mm	—
	Type of support	Top hat rail 35 mm	—
8.4.2.2	Clearances		
	Case A mm) :	3 mm	P
	Case B mm) :	1,2 mm	
	Measured mm) :	12,5 mm	
	Rated impulse withstand voltage Uimp (kV)	4 kV	P
8.4.2.3	Creepage distances:		
	- pollution degree :	3	—
	- comparative tracking index (V) :	600 V	—
	- material group :	I	—
	- rated insulation voltage Ui (V) :	250 V	—
	- minimum creepage distances (mm) :	3,2 mm	—
	- measured creepage distances (mm) :	> 3,2 mm	—
8.4.2	Verification of clearances and creepage distances (type 2006-1601)		
	Conductor type and conductor cross-section	10 mm² rigid	—
	Conductor end length (mm)	13 – 15 mm	—
	Type of support	Top hat rail 35 mm	—
8.4.2.2	Clearances		
	Case A mm) :	8 mm	P
	Case B mm) :	3 mm	
	Measured mm) :	11,25 mm	
	Rated impulse withstand voltage Uimp (kV)	8 kV	P
8.4.2.3	Creepage distances:		
	- pollution degree :	3	—
	- comparative tracking index (V) :	600 V	—
	- material group :	I	—
	- rated insulation voltage Ui (V) :	800 V	—
	- minimum creepage distances (mm) :	10 mm	—
	- measured creepage distances (mm) :	> 11,25 mm	—

IEC 60947-7-1			
Clause	Requirement – Test	Result - Remark	Verdict
8.4.2	Verification of clearances and creepage distances (type 2006-8601)		
	Conductor type and conductor cross-section	10 mm² rigid	—
	Conductor end length (mm)	13 - 15 mm	—
	Type of support	Top hat rail 35 mm	—
8.4.2.2	Clearances		
	Case A mm) :	14 mm	P
	Case B mm) :	4,5 mm	
	Measured mm) :	14,68 mm	
	Rated impulse withstand voltage Uimp (kV)	12 kV	P
8.4.2.3	Creepage distances:		
	- pollution degree :	3	—
	- comparative tracking index (V) :	600 V	—
	- material group :	I	—
	- rated insulation voltage Ui (V) :	1000 Vac / 1500 Vdc	—
	- minimum creepage distances (mm) :	20 mm	—
	- measured creepage distances (mm) :	> 25 mm	—
8.4	Verification of electrical characteristics		
8.4.3	Dielectric tests (types 2006-1306 and 2006-1601)		
	Dielectric test, Uimp indicated:		
	- five terminal blocks connected with unfavourable cross-section (mm ²) / type / conductor end length (mm) :	10 mm², rigid, 13 - 15 mm	—
	- rated impulse withstand voltage (kV) :	8 kV	—
	- test Uimp main circuits (kV) :	9,8 kV	P
	Dielectric test, Uimp not indicated:		
	- five terminal blocks connected with unfavourable cross-section (mm ²) / type / conductor end length (mm) :	10 mm², rigid, 13 - 15 mm	—
	- rated insulation voltage (V) :	800 V	—

IEC 60947-7-1			
Clause	Requirement – Test	Result - Remark	Verdict
	- test voltage for 60 sec (V)	2000 V tested for 5 s According to IEC 60947-1 A2:2014 re-testing according to 60 s is not necessary	P
8.4.3	Dielectric tests (type 2006-1306)		
	Dielectric test, Uimp indicated:		
	- five terminal blocks connected with unfavourable cross-section (mm ²) / type / conductor end length (mm)	10 mm², rigid, 13 - 15 mm	—
	- rated impulse withstand voltage (kV)	8 kV	—
	- test Uimp main circuits (kV)	9,8 kV	P
	Dielectric test, Uimp not indicated:		
	- five terminal blocks connected with unfavourable cross-section (mm ²) / type / conductor end length (mm) :	10 mm², rigid, 13 - 15 mm	—
	- rated insulation voltage (V)	1000 Vac /1500 Vdc	—
	- test voltage for 60 sec (V)	2200 Vac / 3820 Vdc	P
8.4.3	Dielectric tests (types 2006-7114)		
	Dielectric test, Uimp indicated:		
	- five terminal blocks connected with unfavourable cross-section (mm ²) / type / conductor end length (mm)	10 mm², rigid, 13 - 15 mm	—
	- rated impulse withstand voltage (kV)	4 kV	—
	- test Uimp main circuits (kV)	4,8 kV	P
	Dielectric test, Uimp not indicated:		
	- five terminal blocks connected with unfavourable cross-section (mm ²) / type / conductor end length (mm) :	10 mm², rigid, 13 - 15 mm	—
	- rated insulation voltage (V)	250 V	—

IEC 60947-7-1			
Clause	Requirement – Test	Result - Remark	Verdict
	- test voltage for 60 sec (V)	1500 V tested for 5 s According to IEC 60947-1 A2:2014 re-testing according to 60 s is not necessary	P
8.4.3	Dielectric tests (type 2006-8601)		
	Dielectric test, Uimp indicated:		
	- five terminal blocks connected with unfavourable cross-section (mm ²) / type / conductor end length (mm)	10 mm², rigid, 13 - 15 mm	—
	- rated impulse withstand voltage (kV)	12 kV	—
	- test Uimp main circuits (kV)	14,8 kV	P
	Dielectric test, Uimp not indicated:		
	- five terminal blocks connected with unfavourable cross-section (mm ²) / type / conductor end length (mm) :	10 mm², rigid, 13 - 15 mm	—
	- rated insulation voltage (V)	1000 Vac / 1500 Vdc	—
	- test voltage for 60 sec (V)	3820 V dc tested for 5 s According to IEC 60947-1 A2:2014 re-testing according to 60 s is not necessary	P
8.4.5	Temperature-rise test (type 2006-1301)		
	Temperature-rise conditions:		
	- test current (A)	41 A	—
	- cross-section of the conductor (mm ²)	6 mm²	—
	- torque (Nm)	screwless	—
	- temperature-rise does not exceed 45 K	28 K - 39 K	
	Voltage drop before and after temperature-rise test:		
	- test current (A) d.c.	4,1 A	—
	- voltage drop (mV) before temperature-rise test not exceeding 3,2 mV	1,71 mV – 2,11 mV	P

IEC 60947-7-1			
Clause	Requirement – Test	Result - Remark	Verdict
	If the measured value exceeds 3,2 mV, the voltage drop is determined on each individual clamping unit separately, which shall not exceed 1,6 mV		N/A
	- voltage drop (mV) after temperature-rise test not exceeding 150% of the value measured before temperature-rise test	1,74 mV – 2,11 mV	P

8.4.5	Temperature-rise test (type 2006-1301)		
	Temperature-rise conditions:		
	- test current (A)	57 A	—
	- cross-section of the conductor (mm ²)	10 mm ²	—
	- torque (Nm)	screwless	—
	- temperature-rise does not exceed 45 K	28 K - 39 K	P
	Voltage drop before and after temperature-rise test:		
	- test current (A) d.c.	5,7 A	—
	- voltage drop (mV) before temperature-rise test not exceeding 3,2 mV	1,61 mV – 1,81 mV	P
	If the measured value exceeds 3,2 mV, the voltage drop is determined on each individual clamping unit separately, which shall not exceed 1,6 mV		N/A
	- voltage drop (mV) after temperature-rise test not exceeding 150% of the value measured before temperature-rise test	1,57 mV – 1,86 mV	P

8.4.5	Temperature-rise test (type 2006-8601)		
	Temperature-rise conditions:		
	- test current (A)	30 A (terminal block is provided with disconnect part, which cannot be operated.	—
	- cross-section of the conductor (mm ²)	6 mm ²	—
	- torque (Nm)	screwless	—
	- temperature-rise does not exceed 45 K	21,8 K - 29,3 K	P

IEC 60947-7-1			
Clause	Requirement – Test	Result - Remark	Verdict
	Voltage drop before and after temperature-rise test:		
	- test current (A) d.c. :	4,1 A	—
	- voltage drop (mV) before temperature-rise test not exceeding 3,2 mV		N/A
	If the measured value exceeds 3,2 mV, the voltage drop is determined on each individual clamping unit separately, which shall not exceed 1,6 mV	0,55 mV – 1,16 mV	P
	- voltage drop (mV) after temperature-rise test not exceeding 150% of the value measured before temperature-rise test	0,58 mV – 1,71 mV	P
8.4.6	Short-time withstand current test (type 2006-3101)		
	- rated cross-section of the conductor (mm ²)	6 mm²	—
	- torque (Nm)	screwless	—
	- test current (A)	720 A	—
	- duration of the test current (s)	1 s	—
	At the end of the test, continuity shall exist on the test sample assembly and the terminal blocks shall not show any cracking, breakage or other critical damage		P
	Voltage drop before and after short-time withstand current test		
	- test current (A) d.c. :	4,1	—
	- voltage drop (mV) before short-time withstand current test not exceeding 3,2 mV	1,99 mV	P
	If the measured value exceeds 3,2 mV, the voltage drop is determined on each individual clamping unit separately, which shall not exceed 1,6 mV		N
	- voltage drop (mV) after short-time withstand current test not exceeding 150% of the value measured before short-time withstand current test	2,15 mV	P
	- rated cross-section of the conductor (mm ²)	10 mm²	—
	- torque (Nm)	screwless	—

IEC 60947-7-1			
Clause	Requirement – Test	Result - Remark	Verdict
	- test current (A)	1200 A	—
	- duration of the test current (s)	1 s	—
	At the end of the test, continuity shall exist on the test sample assembly and the terminal blocks shall not show any cracking, breakage or other critical damage		P
	Voltage drop before and after short-time withstand current test		
	- test current (A) d.c.	5,7 A	—
	- voltage drop (mV) before short-time withstand current test not exceeding 3,2 mV	1,68 mV	P
	If the measured value exceeds 3,2 mV, the voltage drop is determined on each individual clamping unit separately, which shall not exceed 1,6 mV		N
	- voltage drop (mV) after short-time withstand current test not exceeding 150% of the value measured before short-time withstand current test	1,89 mV	P
8.4.6	Short-time withstand current test (type 2006-8601)		
	- rated cross-section of the conductor (mm ²)	6 mm²	—
	- torque (Nm)	screwless	—
	- test current (A)	720 A	—
	- duration of the test current (s)	1 s	—
	At the end of the test, continuity shall exist on the test sample assembly and the terminal blocks shall not show any cracking, breakage or other critical damage		P
	Voltage drop before and after short-time withstand current test		
	- test current (A) d.c.	4,1	—
	- voltage drop (mV) before short-time withstand current test not exceeding 3,2 mV		N/A

IEC 60947-7-1			
Clause	Requirement – Test	Result - Remark	Verdict
	If the measured value exceeds 3,2 mV, the voltage drop is determined on each individual clamping unit separately, which shall not exceed 1,6 mV	0,91	P
	- voltage drop (mV) after short-time withstand current test not exceeding 150% of the value measured before short-time withstand current test :	0,95	P
8.4.7	Ageing test (for screwless-type terminal blocks only) (type 2006-1301)		
	Maximum ambient temperature (°C)	40 °C /	—
	Rated cross-section rigid or stranded < 10 mm ² solid, > 10 mm ² stranded (mm ²)	6 mm²	—
	Test current (A) according 8.4.5	41 A	—
	Heating cabinet is increased, in each cycle to (°C) :		—
	Test current (A) d.c. for measurement of the voltage drop	4,1 A	—
	Voltage drop after 0 cycles:		
	- requirement: ≤ 3,2 mV (mV)	1 – 1,40 mV 2 – 1,20 mV 3 – 1,60 mV 4 – 1,70 mV 5 – 1,80 mV	P
	If the measured value exceeds 3,2 mV, the voltage drop is determined on each individual clamping unit separately, which shall not exceed 1,6 mV		P
	Voltage drop after the 24th cycle:		
	- requirement: 4,8 mV (mV)	1 – 1,40 mV 2 – 1,20 mV 3 – 1,60 mV 4 – 1,70 mV 5 – 1,80 mV	P
	Voltage drop after the 48th cycle		

IEC 60947-7-1			
Clause	Requirement – Test	Result - Remark	Verdict
	- requirement: $\leq 4,8$ mV or 1,5 times the value measured after the 24th cycle (mV)	1 – 1,40 mV 2 – 1,20 mV 3 – 1,60 mV 4 – 1,70 mV 5 – 1,80 mV	P
	Voltage drop after the 72nd cycle:		
	- requirement: $\leq 4,8$ mV or 1,5 times the value measured after the 24th cycle (mV)	1 – 1,40 mV 2 – 1,20 mV 3 – 1,60 mV 4 – 1,70 mV 5 – 1,80 mV	P
	Voltage drop after the 96th cycle:		
	- requirement: $\leq 4,8$ mV or 1,5 times the value measured after the 24th cycle (mV)	1 – 1,40 mV 2 – 1,20 mV 3 – 1,60 mV 4 – 1,70 mV 5 – 1,80 mV	P
	Voltage drop after the 120th cycle:		
	- requirement: $\leq 4,8$ mV or 1,5 times the value measured after the 24th cycle (mV)	1 – 1,40 mV 2 – 1,20 mV 3 – 1,60 mV 4 – 1,70 mV 5 – 1,80 mV	P
	Voltage drop after the 144th cycle:		
	- requirement: $\leq 4,8$ mV or 1,5 times the value measured after the 24th cycle (mV)	1 – 1,40 mV 2 – 1,20 mV 3 – 1,60 mV 4 – 1,70 mV 5 – 1,80 mV	P
	Voltage drop after the 168th cycle:		

IEC 60947-7-1			
Clause	Requirement – Test	Result - Remark	Verdict
	- requirement: $\leq 4,8$ mV or 1,5 times the value measured after the 24th cycle (mV)	1 – 1,40 mV 2 – 1,20 mV 3 – 1,60 mV 4 – 1,70 mV 5 – 1,80 mV	P
	Voltage drop after the 192nd cycle:		
	- requirement: $\leq 4,8$ mV or 1,5 times the value measured after the 24th cycle (mV)	1 – 1,40 mV 2 – 1,20 mV 3 – 1,60 mV 4 – 1,70 mV 5 – 1,80 mV	P
	Pull-out test		
	force (N)	80 N	—
	1 min, the conductor shall neither slip out of the terminal nor break near the clamping unit		P
8.4.7	Ageing test (for screwless-type terminal blocks only) (type 2006-1301)		
	Maximum ambient temperature (°C)	40 °C /	—
	Rated cross-section rigid or stranded < 10 mm ² solid, > 10 mm ² stranded (mm ²)	10 mm²	—
	Test current (A) according 8.4.5	57 A	—
	Heating cabinet is increased, in each cycle to (°C)		—
	Test current (A) d.c. for measurement of the voltage drop	5,7 A	—
	Voltage drop after 0 cycles:		
	- requirement: $\leq 3,2$ mV (mV)	1 – 1,62 mV 2 – 1,75 mV 3 – 1,45 mV 4 – 1,45 mV 5 – 1,50 mV	P

IEC 60947-7-1			
Clause	Requirement – Test	Result - Remark	Verdict
	If the measured value exceeds 3,2 mV, the voltage drop is determined on each individual clamping unit separately, which shall not exceed 1,6 mV		N/A
	Voltage drop after the 24th cycle:		
	- requirement: 4,8 mV (mV)	1 – 1,69 mV 2 – 1,81 mV 3 – 1,49 mV 4 – 1,49 mV 5 – 1,53 mV	P
	Voltage drop after the 48th cycle		
	- requirement: $\leq 4,8$ mV or 1,5 times the value measured after the 24th cycle (mV)	1 – 1,64 mV 2 – 1,81 mV 3 – 1,49 mV 4 – 1,49 mV 5 – 1,53 mV	P
	Voltage drop after the 72nd cycle:		
	- requirement: $\leq 4,8$ mV or 1,5 times the value measured after the 24th cycle (mV)	1 – 1,65 mV 2 – 1,82 mV 3 – 1,49 mV 4 – 1,50 mV 5 – 1,53 mV	P
	Voltage drop after the 96th cycle:		
	- requirement: $\leq 4,8$ mV or 1,5 times the value measured after the 24th cycle (mV)	1 – 1,65 mV 2 – 1,83 mV 3 – 1,49 mV 4 – 1,50 mV 5 – 1,53 mV	P
	Voltage drop after the 120th cycle:		

IEC 60947-7-1			
Clause	Requirement – Test	Result - Remark	Verdict
	- requirement: $\leq 4,8$ mV or 1,5 times the value measured after the 24th cycle (mV)	1 – 1,66 mV 2 – 1,84 mV 3 – 1,49 mV 4 – 1,50 mV 5 – 1,53 mV	P
	Voltage drop after the 144th cycle:		
	- requirement: $\leq 4,8$ mV or 1,5 times the value measured after the 24th cycle (mV)	1 – 1,66 mV 2 – 1,84 mV 3 – 1,49 mV 4 – 1,50 mV 5 – 1,54 mV	P
	Voltage drop after the 168th cycle:		
	- requirement: $\leq 4,8$ mV or 1,5 times the value measured after the 24th cycle (mV)	1 – 1,66 mV 2 – 1,84 mV 3 – 1,49 mV 4 – 1,50 mV 5 – 1,54 mV	P
	Voltage drop after the 192nd cycle:		
	- requirement: $\leq 4,8$ mV or 1,5 times the value measured after the 24th cycle (mV)	1 – 1,66 mV 2 – 1,84 mV 3 – 1,49 mV 4 – 1,50 mV 5 – 1,54 mV	P
	Pull-out test		
	force (N)	90 N	—
	1 min, the conductor shall neither slip out of the terminal nor break near the clamping unit		P
8.5	Verification of thermal characteristics is checked by the needle flame test.		P
	Before the test, the terminal blocks are stored for 24 h in an atmosphere having a temperature between 15°C and 35°C and a relative humidity		P

IEC 60947-7-1			
Clause	Requirement – Test	Result - Remark	Verdict
	between 45% and 75%		
	The flame is applied for 10 s. for insulation walls <1 mm and / or an area < 100 mm ² , the flame is applied for 5 s.	5 s	P
	The terminal blocks are considered to have passed the test if the duration of burning is < 30s in case of ignition. Moreover, the tissue paper on the pinewood board shall not ignite if burning or glowing particles fall from the terminal block.		P
8.6	Verification of EMC characteristics		
	Subclause 8.4 of IEC 60947-1 applies with the following addition:		N/A
8.6.1	Immunity		N/A
	Terminal blocks within the scope of this standard are not sensitive of electromagnetic disturbances and therefore no immunity tests are necessary.		N/A
8.6.2	Emission		N/A
	Terminal blocks within the scope of this standard do not generate electromagnetic disturbances and therefore no emission tests are necessary.		N/A

IEC 60947-7-1			
Clause	Requirement – Test	Result - Remark	Verdict
Annex A	vacant		N/A
Annex B	informative		N/A
	Items subject to agreement between manufacturer and user		
Annex C	vacant		N/A
Annex D	ADDITIONAL REQUIREMENTS FOR TEST DISCONNECT TERMINALBLOCKS		
D5	Product information		
	- service life in number of cycles	200 x	P
D6.	Normal service, mounting and transport conditions		
	Clause 6 applies.		P
D7	Construction and performance conditions		
	Clause 7 applies with the following additions		
D7.1	Constructional requirements		
D7.1.3	Clearances and creepages are not required to be measured over the open disconnect contacts (Gap). However, the rated impulse withstand voltage (Uimp) stated by the manufacturer according to table 13 of IEC 60947-1, without using the altitude correction factor, shall be verified across the open disconnect contacts (gap) (see D.7.2.2)	4 kV (2006-7114) 8 kV (2006-1601) 12 kV (2006-8671)	P
D7.1.7	Disconnect unit		
	For longitudinal and perpendicular disconnection, test disconnect terminal blocks may be equipped with disconnect units, for instance of the following type: - plug - knife	Slide (2006-7114) Knife (2006-1601) Knife (2006-8671)	P

IEC 60947-7-1			
Clause	Requirement – Test	Result - Remark	Verdict
	- slide (with or without busbar)		
	the position of the disconnect unit shall be recognizable in normal use and shall not be changed unintentionally		P

D.7.2.2	Dielectric properties		
	Dielectric test, Uimp indicated:		
	- five terminal blocks connected with unfavourable cross-section (mm ²) / type / conductor end length tested over open disconnect contacts (gap) (mm)	10 mm², rigid, 13 - 15 mm	—
	- rated impulse withstand voltage (kV)	4 kV (2006-7114) 8 kV (2006-1601) 12 kV (2006-8671)	—
	- test Uimp without altitude correction factor (kV) :	4 kV (2006-7114) 8 kV (2006-1601) 12 kV (2006-8671)	P
D.8.4.5	Temperature-rise test		
	Temperature-rise conditions: (type 2006-7114)		
	- test current (A)	41 A	—
	- cross-section of the conductor (mm ²)	6 mm²	—
	- torque (Nm)	screwless	—
	- torque disconnect unit (Nm)	screwless	—
	- temperature-rise does not exceed 45 K	33 K – 40 K	P
	Voltage drop before and after temperature-rise test:		
	- test current (A) d.c.	4,1 A	—

IEC 60947-7-1			
Clause	Requirement – Test	Result - Remark	Verdict
	- voltage drop (mV) before temperature-rise test not exceeding 1,6 mV times the total of conductor clamping unit and disconnect unit contact points	1,21 mV – 1,32 mV	P
	If the measured value exceeds this calculated value, the voltage drop is measured on each individual conductor clamping unit and disconnect unit contact point. it shall not exceed 1,6 mV on any conductor clamping unit and disconnect unit contact point		N
	- voltage drop (mV) after temperature-rise test not exceeding 150% of the value measured before temperature-rise test	1,18 mV – 1,31 mV	P
D.8.4.5	Temperature-rise test		
	Temperature-rise conditions: (type 2006-7114)		
	- test current (A)	51 A	—
	- cross-section of the conductor (mm ²)	10 mm²	—
	- torque (Nm)	screwless	—
	- torque disconnect unit (Nm)	screwless	—
	- temperature-rise does not exceed 45 K	29 K - 38 K	P
	Voltage drop before and after temperature-rise test:		
	- test current (A) d.c.	5,7 A	—
	- voltage drop (mV) before temperature-rise test not exceeding 1,6 mV times the total of conductor clamping unit and disconnect unit contact points	1,65 mV – 1,88 mV	P
	If the measured value exceeds this calculated value, the voltage drop is measured on each individual conductor clamping unit and disconnect unit contact point. it shall not exceed 1,6 mV on any conductor clamping unit and disconnect unit contact point		N

IEC 60947-7-1			
Clause	Requirement – Test	Result - Remark	Verdict
	- voltage drop (mV) after temperature-rise test not exceeding 150% of the value measured before temperature-rise test	1,62 mV – 1,71 mV	P
D.8.4.5	Temperature-rise test		
	Temperature-rise conditions: (type 2006-1601)		
	- test current (A)	30 A	—
	- cross-section of the conductor (mm ²)	6 mm²	—
	- torque (Nm)	screwless	—
	- torque disconnect unit (Nm)	screwless	—
	- temperature-rise does not exceed 45 K	20 K - 28 K	P
	Voltage drop before and after temperature-rise test:		
	- test current (A) d.c.	4,1 A	—
	- voltage drop (mV) before temperature-rise test not exceeding 1,6 mV times the total of conductor clamping unit and disconnect unit contact points	4 x 1,6 mV = 6,4 mV 3,02 mV – 3,31 mV	P
	If the measured value exceeds this calculated value, the voltage drop is measured on each individual conductor clamping unit and disconnect unit contact point. it shall not exceed 1,6 mV on any conductor clamping unit and disconnect unit contact point		N
	- voltage drop (mV) after temperature-rise test not exceeding 150% of the value measured before temperature-rise test	3,10 mV – 3,35 mV	P
D.8.4.5	Temperature-rise test		
	Temperature-rise conditions: (type 2006-8671)		
	- test current (A)	30 A	—
	- cross-section of the conductor (mm ²)	6 mm²	—
	- torque (Nm)	screwless	—
	- torque disconnect unit (Nm)	screwless	—
	- temperature-rise does not exceed 45 K	21,8 K – 29,3 K	P

IEC 60947-7-1			
Clause	Requirement – Test	Result - Remark	Verdict
	Voltage drop before and after temperature-rise test:		
	- test current (A) d.c. :	4,1 A	—
	- voltage drop (mV) before temperature-rise test not exceeding 1,6 mV times the total of conductor clamping unit and disconnect unit contact points	4 x 1,6 mV = 6,4 mV 3,8 mV – 5,81 mV	P
	If the measured value exceeds this calculated value, the voltage drop is measured on each individual conductor clamping unit and disconnect unit contact point. it shall not exceed 1,6 mV on any conductor clamping unit and disconnect unit contact point		N
	- voltage drop (mV) after temperature-rise test not exceeding 150% of the value measured before temperature-rise test	4,08 mV - 4,62 mV	P
D.8.4.6	Short-time withstand current test (type 2006-7114)		
	- rated cross-section of the conductor (mm ²)	10 mm²	—
	- torque (Nm)	screwless	—
	- torque disconnect unit (Nm)	screwless	—
	- test current (A)	1200 A	—
	- duration of the test current (s)		—
	At the end of the test, continuity shall exist on the test sample assembly and the terminal blocks shall not show any cracking, breakage or other critical damage		P
	Voltage drop before and after short-time withstand current test		
	- test current (A) d.c. :	5,7 A	—
	- voltage drop (mV) before temperature-rise test not exceeding 1,6 mV times the total of conductor clamping unit and disconnect unit contact points	1,15 mV	P

IEC 60947-7-1			
Clause	Requirement – Test	Result - Remark	Verdict
	If the measured value exceeds this calculated value, the voltage drop is measured on each individual conductor clamping unit and disconnect unit contact point. it shall not exceed 1,6 mV on any conductor clamping unit and disconnect unit contact point		N
	- voltage drop (mV) after temperature-rise test not exceeding 150% of the value measured before temperature-rise test	1,28 mV	P
D.8.4.6	Short-time withstand current test (type 2006-1601)		
	- rated cross-section of the conductor (mm ²)	4 mm²	—
	- torque (Nm)	screwless	—
	- torque disconnect unit (Nm)	screwless	—
	- test current (A)	480 A	—
	- duration of the test current (s)		—
	At the end of the test, continuity shall exist on the test sample assembly and the terminal blocks shall not show any cracking, breakage or other critical damage		P
	Voltage drop before and after short-time withstand current test		
	- test current (A) d.c.	3,2 A	—
	- voltage drop (mV) before temperature-rise test not exceeding 1,6 mV times the total of conductor clamping unit and disconnect unit contact points	4 x 1,6 mV = 6,4 mV 3,34 mV	P
	If the measured value exceeds this calculated value, the voltage drop is measured on each individual conductor clamping unit and disconnect unit contact point. it shall not exceed 1,6 mV on any conductor clamping unit and disconnect unit contact point		N

IEC 60947-7-1			
Clause	Requirement – Test	Result - Remark	Verdict
	- voltage drop (mV) after temperature-rise test not exceeding 150% of the value measured before temperature-rise test	3,26 mV	P
D.8.4.6	Short-time withstand current test (type 2006-8671)		
	- rated cross-section of the conductor (mm ²)	6 mm²	—
	- torque (Nm)	screwless	—
	- torque disconnect unit (Nm)	screwless	—
	- test current (A)	720 A	—
	- duration of the test current (s)		—
	At the end of the test, continuity shall exist on the test sample assembly and the terminal blocks shall not show any cracking, breakage or other critical damage		P
	Voltage drop before and after short-time withstand current test		
	- test current (A) d.c.	4,1 A	—
	- voltage drop (mV) before temperature-rise test not exceeding 1,6 mV times the total of conductor clamping unit and disconnect unit contact points	4 x 1,6 mV = 6,4 mV 3,99 mV	P
	If the measured value exceeds this calculated value, the voltage drop is measured on each individual conductor clamping unit and disconnect unit contact point. it shall not exceed 1,6 mV on any conductor clamping unit and disconnect unit contact point		N
	- voltage drop (mV) after temperature-rise test not exceeding 150% of the value measured before temperature-rise test	3,52 mV	P

IEC 60947-7-1			
Clause	Requirement – Test	Result - Remark	Verdict
D.8.4.7	Ageing test for test disconnect terminal blocks with screwless-type clamping units See clause 8.4.7		
	Maximum ambient temperature (°C)	40 °C /	—
	Rated cross-section rigid or stranded < 10 mm ² solid, > 10 mm ² stranded (mm ²)		—
	Test current (A) according D.8.4.5		—
	Torque disconnect unit (Nm)		—
	Heating cabinet is increased, in each cycle to (°C)		—
	Test current (A) d.c. for measurement of the voltage drop		—
	Voltage drop after 0 cycles:		
	- requirement: ≤ 1,6 mV (mV) the voltage drop is determined on each individual clamping unit separately	1 - 2 - 3 - 4 - 5 -	N/A
	Voltage drop after the 24th cycle:		
	- requirement: 2,4 mV (mV)	1 - 2 - 3 - 4 - 5 -	N/A
	Voltage drop after the 48th cycle		
	- requirement: ≤ 2,4 mV or 1,5 times the value measured after the 24th cycle, whichever is the lower (mV)	1 - 2 - 3 - 4 - 5 -	N/A
	Voltage drop after the 72nd cycle:		

IEC 60947-7-1			
Clause	Requirement – Test	Result - Remark	Verdict
	- requirement: $\leq 2,4$ mV or 1,5 times the value measured after the 24th cycle, whichever is the lower (mV)	1 - 2 - 3 - 4 - 5 -	N/A
	Voltage drop after the 96th cycle:		
	- requirement: $\leq 2,4$ mV or 1,5 times the value measured after the 24th cycle, whichever is the lower (mV)	1 - 2 - 3 - 4 - 5 -	N/A
	Voltage drop after the 120th cycle:		
	- requirement: $\leq 2,4$ mV or 1,5 times the value measured after the 24th cycle, whichever is the lower (mV)	1 - 2 - 3 - 4 - 5 -	N/A
	Voltage drop after the 144th cycle:		
	- requirement: $\leq 2,4$ mV or 1,5 times the value measured after the 24th cycle, whichever is the lower (mV)	1 - 2 - 3 - 4 - 5 -	N/A
	Voltage drop after the 168th cycle:		
	- requirement: $\leq 2,4$ mV or 1,5 times the value measured after the 24th cycle, whichever is the lower (mV)	1 - 2 - 3 - 4 - 5 -	N/A
	Voltage drop after the 192nd cycle:		

IEC 60947-7-1			
Clause	Requirement – Test	Result - Remark	Verdict
	- requirement: $\leq 2,4$ mV or 1,5 times the value measured after the 24th cycle, whichever is the lower (mV)	1 - 2 - 3 - 4 - 5 -	N/A
	Pull-out test		
	force (N)		—
	1 min, the conductor shall neither slip out of the terminal nor break near the clamping unit		N/A
D.8.5.1	Service life (type 2006-7114)		
	- rated cross-section of the conductor (mm ²)	10 mm²	—
	- torque (Nm)	screwless	—
	- torque disconnect unit (Nm)	screwless	—
	- number of operating cycles	200 x	—
	Entire test apparatus is stored for 168 h in dry heat at a temperature of 85 °C		P
	Voltage drop before and after service life		
	- test current (A) d.c.	5,7 A	—
	- voltage drop (mV) before service life test not exceeding 1,6 mV times the total of conductor clamping unit and disconnect unit contact points :	1,48 mV – 1,61 mV	P
	If the measured value exceeds this calculated value, the voltage drop is measured on each individual conductor clamping unit and disconnect unit contact point. it shall not exceed 1,6 mV on any conductor clamping unit and disconnect unit contact point		N
	- voltage drop (mV) after service life test not exceeding 150% of the value measured before service life test	1,51 mV – 1,68 mV	P

IEC 60947-7-1			
Clause	Requirement – Test	Result - Remark	Verdict
D.8.5.1	Service life (type 2006-1601)		
	- rated cross-section of the conductor (mm ²)	6 mm²	—
	- torque (Nm)	screwless	—
	- torque disconnect unit (Nm)	screwless	—
	- number of operating cycles	200 x	—
	Entire test apparatus is stored for 168 h in dry heat at a temperature of 85 °C		P
	Voltage drop before and after service life		
	- test current (A) d.c.	4,1 A	—
	- voltage drop (mV) before service life test not exceeding 1,6 mV times the total of conductor clamping unit and disconnect unit contact points :	4 x 1,6 mV = 6,4 mV 3,18 mV - 3,32 mV	P
	If the measured value exceeds this calculated value, the voltage drop is measured on each individual conductor clamping unit and disconnect unit contact point. it shall not exceed 1,6 mV on any conductor clamping unit and disconnect unit contact point		N
	- voltage drop (mV) after service life test not exceeding 150% of the value measured before service life test	3,21 mV – 3,36 mV	P
D.8.5.1	Service life (type 2006-8671)		
	- rated cross-section of the conductor (mm ²)	6 mm²	—
	- torque (Nm)	screwless	—
	- torque disconnect unit (Nm)	screwless	—
	- number of operating cycles	200 x	—
	Entire test apparatus is stored for 168 h in dry heat at a temperature of 85 °C		P
	Voltage drop before and after service life		
	- test current (A) d.c.	4,1 A	—

IEC 60947-7-1			
Clause	Requirement – Test	Result - Remark	Verdict
	- voltage drop (mV) before service life test not exceeding 1,6 mV times the total of conductor clamping unit and disconnect unit contact points :	4 x 1,6 mV = 6,4 mV 0,53 – 0,93	P
	If the measured value exceeds this calculated value, the voltage drop is measured on each individual conductor clamping unit and disconnect unit contact point. it shall not exceed 1,6 mV on any conductor clamping unit and disconnect unit contact point		N
	- voltage drop (mV) after service life test not exceeding 150% of the value measured before service life test		
D.8.4.5	Emission		
	Terminal blocks within the scope of this standard are not sensitive of electromagnetic disturbances and therefore no immunity tests are necessary.		P
8.6.2	Emission		
	Terminal blocks within the scope of this standard do not generate electromagnetic disturbances and therefore no emission tests are necessary.		P

IEC 60947-7-1			
Clause	Requirement – Test	Result - Remark	Verdict

8.4.2	TABLE: Clearance And Creepage Distance Measurements type 2006-1306					
clearance cl and creepage distance dcr at/of:	Uimp (V)	U r.m.s. (V)	Required cl (mm)	cl (mm)	required dcr (mm)	dcr (mm)
Live parts to adjacent live parts Live parts to support	8000	800	8	12,5	10	> 14
Supplementary information:						

8.4.2	TABLE: Clearance And Creepage Distance Measurements type 2006-1306					
clearance cl and creepage distance dcr at/of:	Uimp (V)	U r.m.s. (V)	Required cl (mm)	cl (mm)	required dcr (mm)	dcr (mm)
Live parts to adjacent live parts Live parts to support	8000	1000 Vac / 1500 Vdc	8	12,5	5 / 8	> 14
Supplementary information:						

8.4.2	TABLE: Clearance And Creepage Distance Measurements type 2006-7114					
clearance cl and creepage distance dcr at/of:	Uimp (V)	U r.m.s. (V)	Required cl (mm)	cl (mm)	required dcr (mm)	dcr (mm)
Live parts to adjacent live parts Live parts to support	4000	250	3	12,5	3,2	> 3,2
Supplementary information:						

8.4.2	TABLE: Clearance And Creepage Distance Measurements type 2006-1601					
clearance cl and creepage distance dcr at/of:	Uimp (V)	U r.m.s. (V)	Required cl (mm)	cl (mm)	required dcr (mm)	dcr (mm)
Live parts to adjacent live parts Live parts to support	8000	800	8	11,25	10	> 11,25
Supplementary information:						

IEC 60947-7-1			
Clause	Requirement – Test	Result - Remark	Verdict

8.4.2	TABLE: Clearance And Creepage Distance Measurements type 2006-8601					
clearance cl and creepage distance dcr at/of:	Uimp (V)	U r.m.s. (V)	Required cl (mm)	cl (mm)	required dcr (mm)	dcr (mm)
Live parts to adjacent live parts	12000	1000 Vac 1500 Vdc	14	14,68	20	> 25
Live parts to support						
Supplementary information:						

8.4.3	TABLE: Dielectric Strength types 2006-1306 and 2006-1601		
Test voltage applied between:	Test potential applied (V)	Breakdown / flashover (Yes/No)	
Terminal block and adjacent terminal block	2000 V	No	
Terminal block and mounting rail	2000 V	No	
Supplementary information:			

8.4.3	TABLE: Dielectric Strength types 2006-1306		
Test voltage applied between:	Test potential applied (V)	Breakdown / flashover (Yes/No)	
Terminal block and adjacent terminal block	2200 Vac / 3820 Vdc	No	
Terminal block and mounting rail	2200 Vac / 3820 Vdc	No	
Supplementary information:			

8.4.3	TABLE: Dielectric Strength type 2006-7114		
Test voltage applied between:	Test potential applied (V)	Breakdown / flashover (Yes/No)	
Terminal block and adjacent terminal block	1500 V	No	
Terminal block and mounting rail	1500 V	No	
Supplementary information:			

8.4.3	TABLE: Dielectric Strength type 2006-8601		
Test voltage applied between:	Test potential applied (V)	Breakdown / flashover (Yes/No)	
Terminal block and adjacent terminal block	3820 V	No	
Terminal block and mounting rail	3820 V	No	
Supplementary information:			

IEC 60947-7-1			
Clause	Requirement – Test	Result - Remark	Verdict
8.4.5	TABLE: Heating Test type 2006-8601		
	Test voltage (V):	< 3 V	—
	Ambient (°C):	22,1 °C	—
Thermocouple Locations		max. temperature-rise measured, (K)	max. temperature-rise limit, (K)
CU 1 upper level		27,3	45
CU 2 upper level		28,6	45
CU 3 upper level		25,9	45
CU 4 upper level		26,8	45
CU 5 upper level		21,8	45
Fuse knife		29,3	45
Supplementary information: CU = clamping unit			

Remarks

Product data	
Product	: terminal blocks
Trade name(s)	: WAGO
Type(s)/model(s)	: TOPJOB S 2006
Material	: thermoplastic material
Rated connecting capacity	: 6 mm ² / 10 mm ² rigid and flexible
Connectable conductors	: 0,5 mm ² - 10 mm ² rigid and flexible
Method of mounting	: for mounting on top hat rail 35 mm
Rated current	: 41 A (6 mm ²) 57 A (10 mm ²)
Rated voltage	: 800 V (pollution degree 3) 1000 Vdc / 1500 Vdc (pollution degree 2)
Rated impulse withstand voltage	: 8 kV
Type	: 2006 with suffixes -1201, -1202, -1203, -1204, -1205, -1206, -1208, -1209
Description	: 2 conductor through terminal block, with screwless-type terminals, 1-pole
Type	: 2006-1207
Description	: 2 conductor earth terminal block, with screwless-type terminals, 1-pole
Type	: 2006 with suffixes -1301, -1302, -1303, 1304, -1305, -1306, -1308, -1309
Description	: 3 conductor through terminal block, with screwless-type terminals, 1-pole
Type	: 2006-1307
Description	: 3 conductor earth terminal block, with screwless-type terminals, 1-pole

Remarks

Current	: 41 A (6 mm ²) 51 A (10 mm ²)
Rated voltage	: 250 V (pollution degree 3)
Rated impulse withstand voltage	: 4 kV
Type	: 2006-7114
Description	: 1 conductor N-disconnect terminal block, with screwless terminals and 1 connection for busbar (10 x 3 mm), 1-pole
Type	: 2006-7111
Description	: 1 conductor power distribution disconnect terminal, with screwless terminals and 1 connection for busbar (10 x 3 mm), 1-pole
Current	: 30 A (6 mm ²)
Rated voltage	: 800 V (pollution degree 3)
Rated impulse withstand voltage	: 8 kV
Type	: 2006 with suffixes -1601, -1602, 1603, -1604
Description	: 2 conductor through terminal block (permanently closed disconnect part), with screwless type terminals, 1-pole
Type	: 2006 with suffixes -1661, -1662, -1663, -1664
Description	: 2 conductor carrier terminal block, with screwless-type terminals, 1-pole

Remarks

Current	: 30 A (6 mm ²)
Rated voltage	: 800 V (pollution degree 3)
Rated impulse withstand voltage	: 8 kV
Type	: 2006 with suffixes -1671, -1672, -1673, -1674, -1675
Description	: 2 conductor disconnect terminal block, with screwless type terminals, 1-pole
Type	: optional suffixes for disconnect terminal blocks .../400-0000
Description	: disconnect knife rotated by 180°
Type	: .../401-0000
Description	: with mechanical locking element
Type	: 2006-... with suffixes -1671, - 1675 with additional suffixes /1000-848 provided with LED 24 V /1000-849 provided with LED 48 V /1000-850 provided with neon light 120 V /1000-851 provided with neon light 230 V
Description	: ground conductor disconnect terminal block, with screwless type terminals, 2-poles

Remarks

Current	: 30 A (6 mm ²)
Rated voltage	: 1000 Vac / 1500 Vdc (pollution degree 3)
Rated impulse withstand voltage	: 12 kV
Type	: 2006 with suffixes -8601, -8604
Description	: 2 conductor through terminal block, with screwless type terminals, provided with disconnect part, which cannot be operated
Type	: 2006 with suffixes -8664, -8661
Description	: 2 conductor carrier terminal block, with screwless type terminals, 1 pole
Type	: 2006 with suffixes -8671, -8674
Description	: 2 conductor disconnect terminal block, with screwless type terminals, 1 pole

Remarks

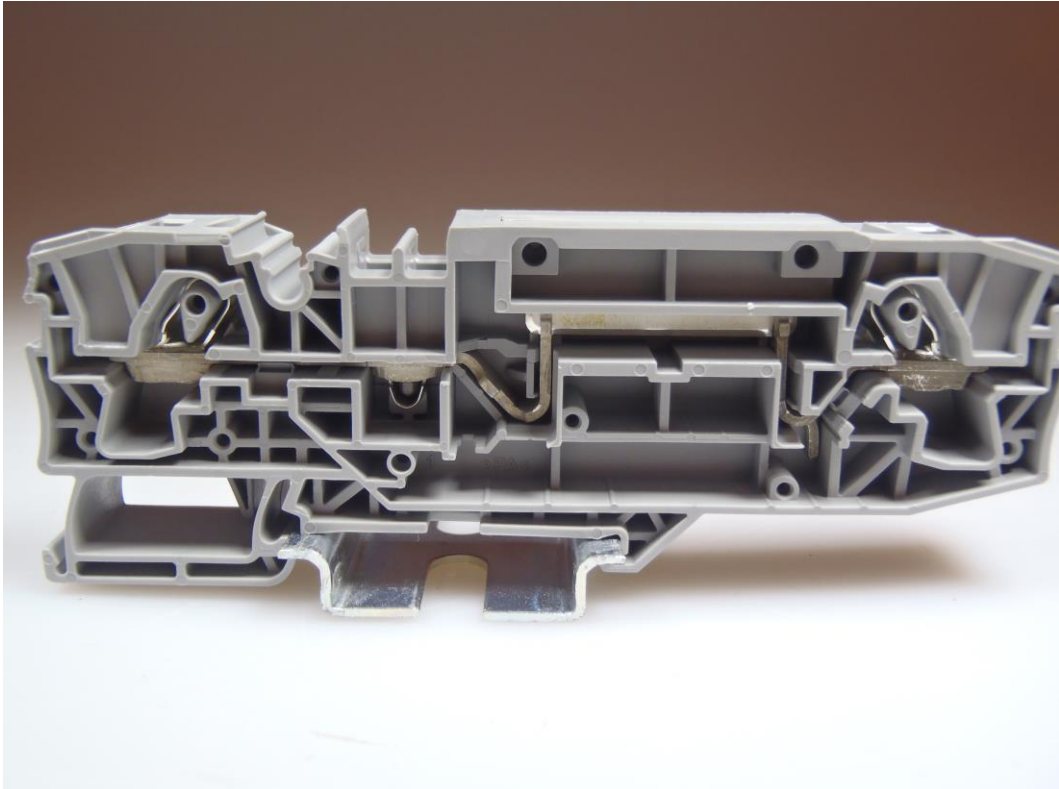

Type 2006-8601

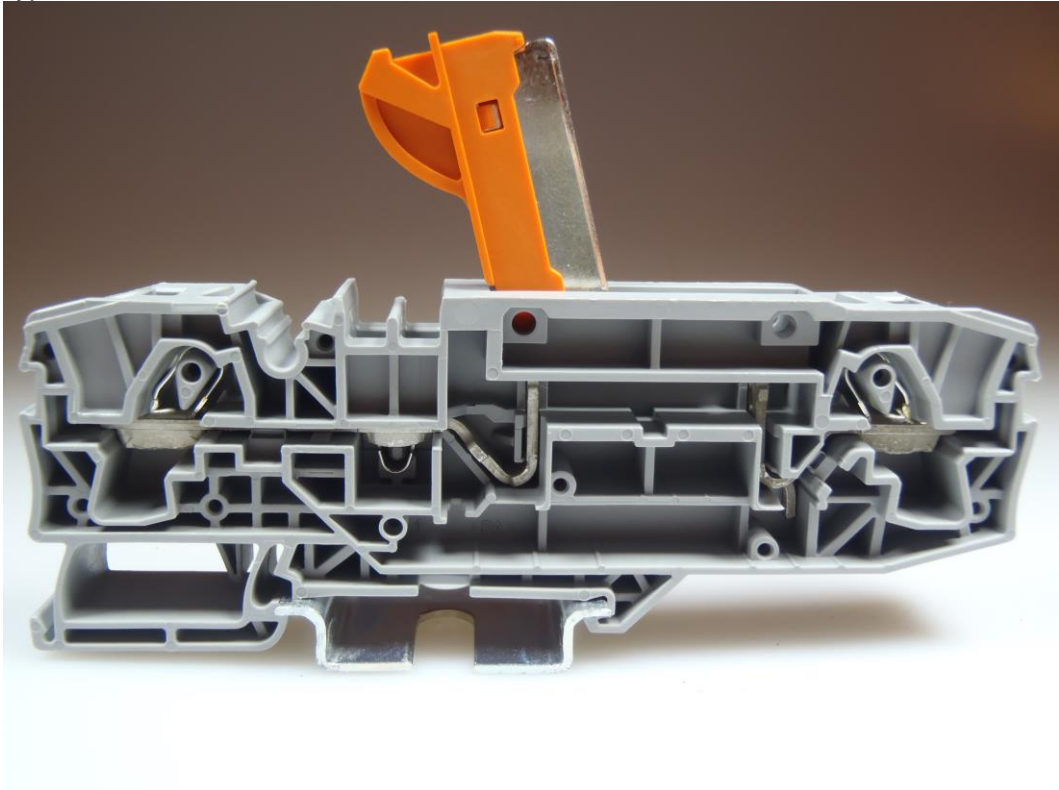

Type 2006-8671

Remarks

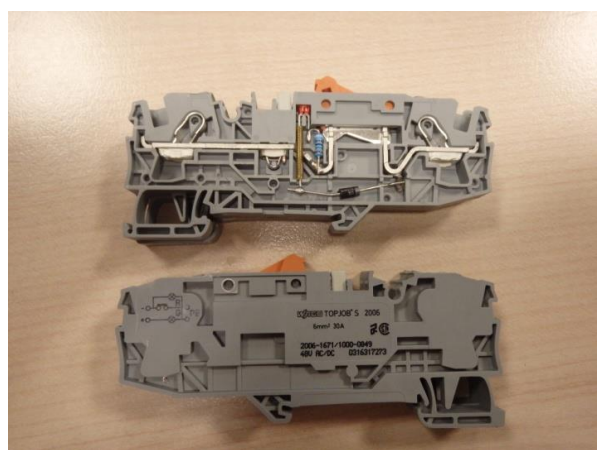
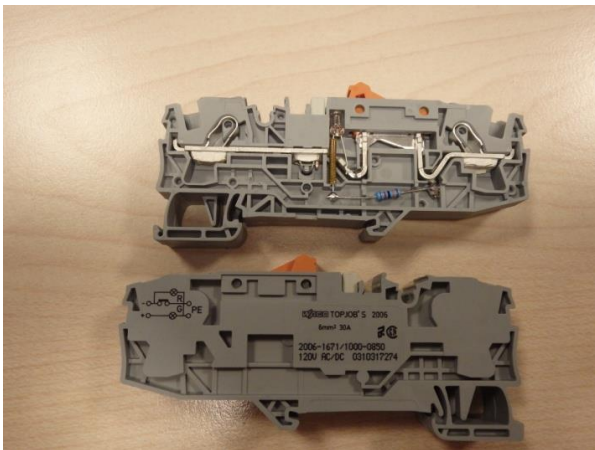
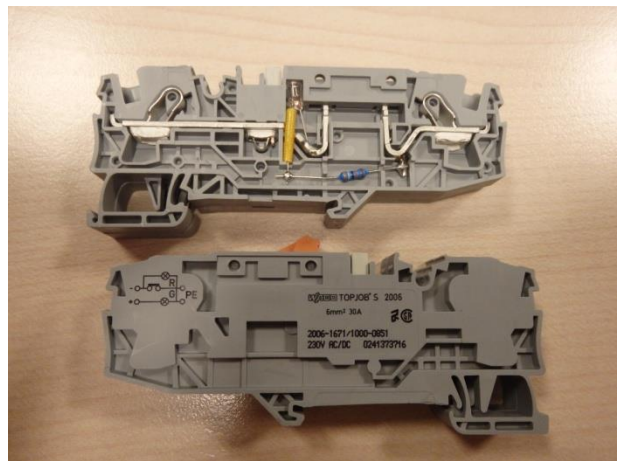
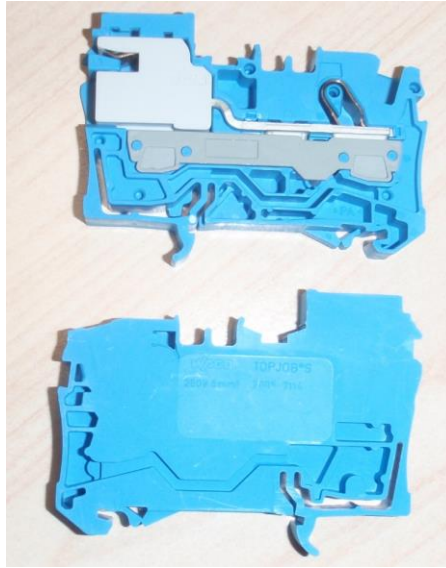
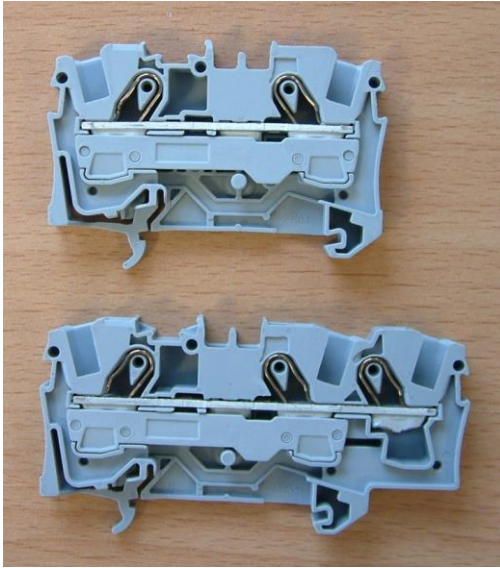





OD ECS 040-1
January 2019

Responsible CB



TEST REPORT SUMMARY

Report Number..... : **2256631.53**
Date of issue..... : **2021-07-06**
Tested by (name, function, signature): **W.C. van Ginkel**
 Technician Industrial Safety 
Witnessed by (name, function, signature):
Approved by (name, function, signature):
Supervised by (name, function, signature): **H.L. Schendstok**
 (Project Manager Industrial Safety) 

Testing Laboratory..... : **DEKRA Certification B.V.**
Address : **Meander 1051, 6825 MJ Arnhem, The Netherlands**
Testing procedure : ENEC CCA NTR
 ENEC based on IECIEE CBTC with number:
Customer Testing Procedure..... : TMP/CTF Stage 1 WMT/CTF Stage 2 SMT/CTF Stage 3

Applicant : **WAGO Kontakttechnik GmbH & Co. KG**
Address : **Hansastraße 27, 32423 Minden/Westfalen, Germany**
Manufacturer : **WAGO Kontakttechnik GmbH & Co. KG**
Address : **Hansastraße 27, 32423 Minden/Westfalen, Germany**

Product..... : **Protective conductor terminal blocks for copper conductors**
Model/Type reference : **TOPJOB S 2006**
Trademark : 
Ratings : **6 mm², 10 mm²**

Certification Scheme : ENEC CCA Other: _____
Standard(s)..... : **EN 60947-7-2: 2009, in conjunction with EN 60947-1: 2007 + A1:2012 + A2:2014**
 The text of the a.m. European Standard was approved by CENELEC is equivalent with the corresponding IEC Publication.
 The text of the a.m. European Standard was approved by CENELEC with agreed common modifications and is not equivalent with the corresponding IEC Publication. An EU Deviation Addendum has to be issued.

This EN test report consists of the following parts:
 IEC Test Report Number..... : **2256631.53**
 EU Deviation Addendum..... :

Copyright © 2019, ETICS Brussels, Belgium. All rights reserved.
This ECS document together with the test report is only valid if signed by an approved ENEC or CCA Testing Laboratory and accompanied by the associated ENEC Licence or CCA Notification of Test Results, issued by a Certification Body member of ECS.



Test Report issued under the responsibility of:



TEST REPORT IEC 60947-7-2 Low-voltage switchgear and controlgear Part 7: Ancillary equipment Section Two: Protective terminal blocks for copper conductors	
Report Number.....	2256631.53
Date of issue	2021-07-06
Total number of pages.....	30
Name of Testing Laboratory preparing the Report.....	DEKRA Certification B.V. Meander 1051, 6825 MJ Arnhem, The Netherlands
Applicant's name	WAGO Kontakttechnik GmbH & Co. KG
Address	Hansastraße 27, 32423 Minden/Westfalen, Germany
Test specification:	
Standard.....	IEC 60947-7-2:2009 (Third Edition) in conjunction with IEC 60947-1 (Fifth Edition) + A1:2012 + A2:2014
Test procedure.....	CB Scheme
Non-standard test method.....	N/A
Test Report Form No.	IEC60947_7_2B
Test Report Form(s) Originator	DEKRA Certification B.V.
Master TRF	Dated 2016-01
Copyright © 2016 IEC System of Conformity Assessment Schemes for Electrotechnical Equipment and Components (IECEE System). All rights reserved.	
This publication may be reproduced in whole or in part for non-commercial purposes as long as the IECEE is acknowledged as copyright owner and source of the material. IECEE takes no responsibility for and will not assume liability for damages resulting from the reader's interpretation of the reproduced material due to its placement and context.	
If this Test Report Form is used by non-IECEE members, the IECEE/IEC logo and the reference to the CB Scheme procedure shall be removed.	
This report is not valid as a CB Test Report unless signed by an approved CB Testing Laboratory and appended to a CB Test Certificate issued by an NCB in accordance with IECEE 02.	
General disclaimer:	
The test results presented in this report relate only to the object tested. This report shall not be reproduced, except in full, without the written approval of the Issuing CB Testing Laboratory. The authenticity of this Test Report and its contents can be verified by contacting the NCB, responsible for this Test Report.	

Test item description	Protective conductor terminal blocks for copper conductors
Trade Mark.....	
Manufacturer	WAGO Kontakttechnik GmbH & Co. KG
Model/Type reference	TOPJOB S 2006
Ratings	6 mm ² or 10 mm ²

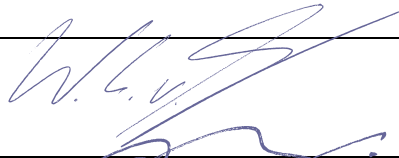
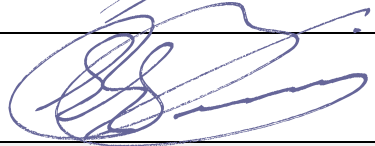
Responsible Testing Laboratory (as applicable), testing procedure and testing location(s):		
<input checked="" type="checkbox"/>	CB Testing Laboratory:	DEKRA Certification B.V.
Testing location/ address		Meander 1051, 6825 MJ Arnhem, The Netherlands
<input type="checkbox"/>	Associated CB Testing Laboratory:	
Testing location/ address		
Tested by (name, function, signature)		W.C. van Ginkel (Technician Industrial Safety) 
Approved by (name, function, signature) .. :		H.L. Schendstok (Project Manager Industrial Safety) 
<hr/>		
<input type="checkbox"/>	Testing procedure: CTF Stage 1:	
Testing location/ address		
Tested by (name, function, signature)		
Approved by (name, function, signature) .. :		
<hr/>		
<input type="checkbox"/>	Testing procedure: CTF Stage 2:	
Testing location/ address		
Tested by (name + signature)		
Witnessed by (name, function, signature) . :		
Approved by (name, function, signature) .. :		
<hr/>		
<input type="checkbox"/>	Testing procedure: CTF Stage 3:	
<input type="checkbox"/>	Testing procedure: CTF Stage 4:	
Testing location/ address		
Tested by (name, function, signature)		
Witnessed by (name, function, signature) . :		
Approved by (name, function, signature) .. :		
Supervised by (name, function, signature) :		
<hr/>		

List of Attachments (including a total number of pages in each attachment): N/A	
Summary of testing:	
<p>Tests performed (name of test and test clause):</p> <p>Complete examination</p> <p>Project 2160584.71 Additional tests are carried out at type 2006-1307 unless otherwise stated</p> <p>Project: 2166989.51 This Test Report replaces test Report 2160584.71 issued on 6 March 2014 due to the fact that types are added.</p> <p>Project 2221172.51 This Test Report replaces test Report 2166989.51 issued on 5 February 2014 due to the fact that types are added in test report 2221172.50.</p> <p>Project 2256631.53 This Test report replaces Test Report 2221172.51 issued on 2017-11-28, due to the fact that the rated voltage of 1000 Vac / 1500 Vdc is added. The following tests are carried out on 2006-1307: - Clause 8.4.3 Further are added additional factory locations.</p>	<p>Testing location:</p> <p>DEKRA Certification B.V. Meander 1051, 6825 MJ Arnhem, The Netherlands</p>
Summary of compliance with National Differences (List of countries addressed): N/A	
<input checked="" type="checkbox"/> The product fulfils the requirements of EN 60947-7-2: 2009.	

Copy of marking plate:

The artwork below may be only a draft. The use of certification marks on a product must be authorized by the respective NCBs that own these marks.

**TOPJOB S 2006****IEC 60947-7-2****6 mm²**

Test item particulars..... :	
Classification of installation and use	Protective conductor terminal blocks for copper conductors
Supply Connection	N/A
Particulars: test item vs. test requirements	
- method of fixing	mounting on top hat rail 35 mm
- number of poles.....	1 pole
- type of clamping unit.....	screwless terminal
- ability to receive conductors	unprepared conductors, flexible or rigid
- number of terminals on terminal assembly	2 and 3
- PE or PEN functions.....	PE or PEN function
- rated cross-section (mm ²)	6 mm² or 10 mm²
- rated connecting capacity (mm ²)	0,5 mm² - 10 mm² rigid and flexible
Possible test case verdicts:	
- test case does not apply to the test object	N/A
- test object does meet the requirement	P (Pass)
- test object does not meet the requirement	F (Fail)
Testing	
Date of receipt of test item	12-2013 / 05-2021
Date (s) of performance of tests.....	12-2013 / 05-2021
General remarks:	
<p>"(See Enclosure #)" refers to additional information appended to the report. "(See appended table)" refers to a table appended to the report.</p> <p>Throughout this report a <input checked="" type="checkbox"/> comma / <input type="checkbox"/> point is used as the decimal separator.</p>	
Manufacturer's Declaration per sub-clause 4.2.5 of IEC 60947-2:	
The application for obtaining a CB Test Certificate includes more than one factory location and a declaration from the Manufacturer stating that the sample(s) submitted for evaluation is (are) representative of the products from each factory has been provided	<input checked="" type="checkbox"/> Yes <input type="checkbox"/> Not applicable
When differences exist; they shall be identified in the General product information section.	

Name and address of factory (ies)

**Wago Elwag sp.z.o.o.
ul. Piekna 58 a
50-506, Wroclaw, Poland**

**Wago Elwag
Innowacyjna 2
55-330 Wroblowice, Poland**

**Wago Pvt. Ltd.
C-27, Sector-58, Phase III
201301 Noida Uttar Pradesh, India**

**Wago Electronic (Tianjin) Co. Ltd.
No. 5 Quanhui Road
Wu Qing Development Area
301700 Tianjin, China**

**WAGO Kontakttechnik GmbH & Co. KG
Hansastraße 27, 32423 Minden/Westfalen
Germany**

**WAGO Kontakttechnik GmbH & Co. KG, Werk
Sondershausen
Waldstrasse 1, 99706, Sondershausen
Germany**

**WAGO Contact S.A.
Route de l'Industrie 19, CP 168, 1564,
Domdidier, Switzerland**

**WAGO Kontakttechnik GmbH & Co. KG
Cammer Str. 17,
32423 Minden
Germany**

General product information:

See page 30 up to 31.

IEC 60947-7-2			
Clause	Requirement – Test	Result - Remark	Verdict
5	PRODUCT INFORMATION		
5.1	Marking		
	Terminal block shall be marked with:		
	- manufacturer's name or trademark		P
	- type designation	TOPJOB S 2006	P
5.2	The following information shall be stated by the manufacturer if applicable, e.g. in the manufacturer's data sheet, or his catalogue or on the packing unit:		
	- manufacturer's claim for compliance with IEC 60 947-7-2	IEC 60947-7-2	P
	- rated cross-section	6 mm ² or 10 mm ²	P
	- rated connecting capacity	0,5 mm ² - 10 mm ² rigid and flexible	P
	- service conditions if different from those of Cl. 6.		P
	The manufacturer shall declare if the protective conductor terminal block rated equal to or above 10 mm ² (AWG 8) is intended for PE function only.		N
7.	CONSTRUCTION		
7.1	Constructional requirements		
7.1.1	Terminals		
	Terminals shall permit a reliable connection between the conductor clamping unit and the clamping unit to the support		P
7.1.7.1	All parts of terminals which maintain contact and carry current shall be of metal having adequate mechanical strength		P
	Clamping units connections shall be such that necessary contact pressure is maintained		P

IEC 60947-7-2			
Clause	Requirement – Test	Result - Remark	Verdict
	Clamping units shall be so constructed that the conductor is clamped between suitable surfaces without damage to the conductor and terminal		P
	Clamping units shall not allow the conductor to be displaced or to be displaced themselves in a manner detrimental to the operation of equipment and the insulation voltage shall not be reduced below the rated value		P
	Clamping units shall allow the conductor to be connected by means ensuring that a reliable mechanical linkage and electrical contact is properly maintained		P
	Clamping units shall be able to withstand the forces that can be applied through the connected conductors		P
	Contact pressure is not transmitted through insulation materials		P
7.1.2	Connection of support		
	Protective conductor terminal blocks are provided with means that allow them to be securely attached to the corresponding support without risk of galvanic corrosion		P
	The design of the protective conductor terminal blocks shall clearly show how the fixation has to be made to ensure the correct conducting connection to appropriate support		P
	The clamping connection to the support shall only be released by means of tools		P
7.1.3	Clearances and creepage distances		
	Clearances and creepage distances do not apply to protective conductor terminal blocks		P
7.1.4	Terminal identification and marking:		

IEC 60947-7-2			
Clause	Requirement – Test	Result - Remark	Verdict
	- terminal blocks shall have provision, or at least space, for identification marks or numbers for each terminal or terminal assembly to be related to the circuit of which it is to form a part		P
	- any partial insulated protective conductor terminal blocks shall be coloured green and yellow		P
7.1.5	Resistance to abnormal heat and fire		
	Needle flame test for insulation materials of terminal blocks (see 8.5)	5 s	P
7.1.6	Rated cross section and rated connecting capacity		
	Terminal blocks are so designed that conductors of the rated cross-section and/or the rated connecting capacity can be accepted	0,5 mm² - 10 mm² rigid and flexible	P
7.1.7	Protective conductor mounting rails		
	Mounting rails may be used as protective conductor busbars, provided the values specified in Table A.1 for thermal short-time withstand current and the thermal rated current are not exceeded	Top hat rail 35 mm	P
	Other types of mounting rails may be used for this purpose if the values of Table A.1 are comparable		N
	Steel protective conductor busbars are not allowed to be used as a PEN conductor		N

8.	TESTS		
8.3	Verification of mechanical characteristics		
8.3.2	Attachment of the terminal block on its support		
	mounting rail	Top hat rail 35 mm	—
	torque (Nm) clamping to support	-	—

IEC 60947-7-2			
Clause	Requirement – Test	Result - Remark	Verdict
	steel pin diameter (mm)	2,8 mm	—
	tightening torque clamping units (Nm)	-	—
	force (N)	5 N	—
	During the test, no terminal block shall work free from its rail or support, nor suffer any other damage		P
8.3.3.1	Test of mechanical strength of clamping units		
8.2.4.2	Mechanical strength of terminals (IEC 60947-1)		
	rated cross-section of a rigid conductor (mm ²) ...	6 mm²	—
	diameter of thread (mm)	-	—
	torque (Nm)	-	—
	5 times on 2 separate clamping units		P
	Voltage drop before and after mechanical strength test		
	rated cross-section of a rigid conductor (mm ²) ...	6 mm²	—
	test current (A) d.c.	4,1 A	—
	voltage drop (mV) before mechanical strength test not exceeding 3,2 mV	1,79 mV – 1,98 mV	P
	If the measured value exceeds 3,2 mV, the voltage drop is determined on each individual clamping unit separately, which shall not exceed 1,6 mV		N
	voltage drop (mV) after mechanical strength test not exceeding 150% of the value measured before mechanical strength test	1,71 mV – 2,11 mV	P
8.2.4.2	Mechanical strength of terminals (EN 60947-1)		
	rated cross-section of a rigid conductor (mm ²) ...	10 mm²	—
	diameter of thread (mm)	-	—
	torque (Nm)	-	—
	5 times on 2 separate clamping units		P
	Voltage drop before and after mechanical strength test		
	rated cross-section of a rigid conductor (mm ²) ...	10 mm²	—
	test current (A) d.c.	5,7 A	—

IEC 60947-7-2			
Clause	Requirement – Test	Result - Remark	Verdict
	voltage drop (mV) before mechanical strength test not exceeding 3,2 mV	1,87 mV – 1,72 mV	P
	If the measured value exceeds 3,2 mV, the voltage drop is determined on each individual clamping unit separately, which shall not exceed 1,6 mV		N
	voltage drop (mV) after mechanical strength test not exceeding 150% of the value measured before mechanical strength test	1,93 mV – 1,68 mV	P
	minimum cross-section of a flexible conductor (mm ²)	0,5 mm²	—
	test current (A) d.c.	0,6 A	—
	voltage drop (mV) before mechanical strength test not exceeding 3,2 mV	1,32 mV – 1,24 mV	P
	If the measured value exceeds 3,2 mV, the voltage drop is determined on each individual clamping unit separately, which shall not exceed 1,6 mV		N
	voltage drop (mV) after mechanical strength test not exceeding 150% of the value measured before mechanical strength test	1,38 mV – 1,18 mV	P
	Mechanical strength of the clamping to support		
	- rail profile	Top hat rail 35 mm	—
	diameter of thread (mm)	-	—
	torque (Nm)	-	—
	5 times on 2 separate clamping units		P
	rated cross-section of a rigid conductor (mm ²) ...	6 mm²	—
	test current (A) d.c.	4,1 A	—
	voltage drop (mV) before mechanical strength test not exceeding 6,4 mV	2,21 mV – 2,06 mV	P
	If the measured value exceeds 6,4 mV, the voltage drop is determined on each individual clamping unit separately, which shall not exceed 4,8 mV		N

IEC 60947-7-2			
Clause	Requirement – Test	Result - Remark	Verdict
	voltage drop (mV) after mechanical strength test not exceeding 150% of the value measured before mechanical strength test	2,14 mV – 2,18 mV	P
	- rail profile	Top hat rail 35 mm	—
	diameter of thread (mm)	-	—
	torque (Nm)	-	—
	5 times on 2 separate clamping units		P
	rated cross-section of a rigid conductor (mm ²) ...	10 mm²	—
	test current (A) d.c.	5,7 A	—
	voltage drop (mV) before mechanical strength test not exceeding 6,4 mV	1,94 mV – 2,02 mV	P
	If the measured value exceeds 6,4 mV, the voltage drop is determined on each individual clamping unit separately, which shall not exceed 4,8 mV		N
	voltage drop (mV) after mechanical strength test not exceeding 150% of the value measured before mechanical strength test	1,96 mV – 2,11 mV	P
8.3.4.2	Testing for damage to and accidental loosening of conductors of a terminal block (flexion test)		
	conductor of the smallest cross-section (mm ²) ...	0,5 mm² rigid and flexible	—
	number of conductor of the smallest cross-section	1	—
	diameter of bushing hole (mm)	6,5 mm	—
	height between the equipment and the platen (mm)	260 mm	—
	mass at the conductor(s) (kg)	0,3 kg	—
	135 continuous revolutions: the conductor shall neither slip out of the terminal nor break near the clamping unit		P
	Pull-out test		
	force (N)	30 N	—

IEC 60947-7-2			
Clause	Requirement – Test	Result - Remark	Verdict
	1 min, the conductor shall neither slip out of the terminal nor break near the clamping unit		P
	conductor of the rated cross-section (mm ²) :	6 mm²	—
	number of conductor of the rated cross-section .. :	1	—
	diameter of bushing hole (mm)	9,5 mm	—
	height between the equipment and the platen (mm)	279 mm	—
	mass at the conductor(s) (kg)	1,4 kg	—
	135 continuous revolutions: the conductor shall neither slip out of the terminal nor break near the clamping unit		P
	Pull-out test		
	force (N)	80 N	—
	1 min, the conductor shall neither slip out of the terminal nor break near the clamping unit		P
	conductor of the rated cross-section (mm ²) :	10 mm²	—
	number of conductor of the rated cross-section .. :	1	—
	diameter of bushing hole (mm)	9,5 mm	—
	height between the equipment and the platen (mm)	279 mm	—
	mass at the conductor(s) (kg)	2 kg	—
	135 continuous revolutions: the conductor shall neither slip out of the terminal nor break near the clamping unit		P
	Pull-out test		
	force (N)	90 N	—
	1 min, the conductor shall neither slip out of the terminal nor break near the clamping unit		P
	conductor of the largest cross-section (mm ²)	10 mm²	—
	number of conductor of the largest cross-section :	1	—
	diameter of bushing hole (mm)	9,5 mm	—

IEC 60947-7-2			
Clause	Requirement – Test	Result - Remark	Verdict
	height between the equipment and the platen (mm)	279 mm	—
	mass at the conductor(s) (kg)	2 kg	—
	135 continuous revolutions: the conductor shall neither slip out of the terminal nor break near the clamping unit		P
	Pull-out test		
	force (N)	90 N	—
	1 min, the conductor shall neither slip out of the terminal nor break near the clamping unit		P
	conductor of the largest or smallest cross-section (mm ²)		—
	number of conductor of the largest or smallest cross-section		—
	torque (Nm)		—
	diameter of bushing hole (mm)		—
	height between the equipment and the platen (mm)		—
	mass at the conductor(s) (kg)		—
	135 continuous revolutions: the conductor shall neither slip out of the terminal nor break near the clamping unit		N
	Pull-out test		
	force (N)		—
	1 min, the conductor shall neither slip out of the terminal nor break near the clamping unit		N
8.3.4.4	Verification of rated cross section and rated connecting capacity		
	One conductor of the two next smaller cross-sections can be unhindered and connected in each clamping unit of one terminal block (up to 35 mm ²)	2,5 mm²	P

IEC 60947-7-2			
Clause	Requirement – Test	Result - Remark	Verdict
8.4.3	Dielectric tests		
	Dielectric test, Uimp indicated:		
	- The test is made on protective terminal blocks installed with terminal blocks of the same series and size according to the manufactures instructions rated cross-section (mm ²) / type / conductor end length (mm)	Type 2006-1301 6 mm² or 10 mm² rigid, 13 mm - 15 mm	—
	- rated impulse withstand voltage (kV)	8 kV	—
	- test Uimp main circuits (kV)	9,8 kV	P
	Dielectric test, Uimp not indicated:		
	- The test is made on protective terminal blocks installed with terminal blocks of the same series and size according to the manufactures instructions rated cross-section (mm ²) / type / conductor end length (mm)	Type 2006-1301 6 mm² or 10 mm² rigid, 13 mm - 15 mm	—
	- rated insulation voltage (V)	800 V	—
	- test voltage for 60 sec (V)	2000 V tested for 5 s According to IEC 60947-1 A2:2014 re-testing according to 60 s is not necessary	P
	- The test is made on protective terminal blocks installed with terminal blocks of the same series and size according to the manufactures instructions rated cross-section (mm ²) / type / conductor end length (mm)	Type 2006-1301 6 mm² or 10 mm² rigid, 13 mm - 15 mm	—
	- rated insulation voltage (V)	1000 Vac / 1500 Vdc	—
	- test voltage for 60 sec (V)	2200 Vac / 3820 Vdc	P
8.4.5	Temperature-rise test		
	Temperature rise conditions:		
	- test current (A)	57 A	—
	- cross-section of the conductor (mm ²)	10 mm²	—
	- torque (Nm) clamping unit	-	—

IEC 60947-7-2			
Clause	Requirement – Test	Result - Remark	Verdict
	- torque (Nm) clamping to support	-	—
	Temperature-rise without support		
	- temperature-rise does not exceed 45 K	23 K – 32 K	P
	Voltage drop before and after temperature-rise test:		
	- test current (A) d.c.	5,7 A	—
	- voltage drop (mV) before temperature-rise test not exceeding 3,2 mV	1,62 mV – 1,81 mV	P
	If the measured value exceeds 3,2 mV, the voltage drop is determined on each individual clamping unit separately, which shall not exceed 1,6 mV		N
	- voltage drop (mV) after temperature-rise test not exceeding 150% of the value measured before temperature rise test	1,60 mV – 1,89 mV	P
	Temperature-rise with support		
	- rail profile and material	Top hat rail 35 mm, Cu	—
	- temperature-rise does not exceed 45 K	14 K	—
	Voltage drop before and after temperature-rise test:		
	- test current (A) d.c.	5,7 A	—
	- voltage drop (mV) before temperature-rise test not exceeding 6,4 mV	1,18 mV – 1,48 mV	P
	If the measured value exceeds 6,4 mV, the voltage drop is determined on each individual clamping unit separately, which shall not exceed 4,8 mV		N
	- voltage drop (mV) after temperature-rise test not exceeding 150% of the value measured before temperature-rise test	1,21 mV – 1,52 mV	P
8.4.6	Short-time withstand current test type		
	- cross-section of the conductor (mm ²)	6 mm ²	—
	- torque (Nm) clamping unit	-	—

IEC 60947-7-2			
Clause	Requirement – Test	Result - Remark	Verdict
	- rail profile and material	Top hat rail 35 mm	—
	- torque (Nm) clamping to support	-	—
	Test current from clamping unit to clamping unit (1-1)		
	- test current (A)	1 – 720 A 2 – 720 A 3 – 720 A	—
	- duration of the test current (s)	1 – 1 s 2 – 1 s 3 – 1 s	—
	At the end of the test, continuity shall exist on the test sample assembly and the terminal blocks shall not show any cracking, breakage or other critical damage		P
	Voltage drop after short-time withstand current test		
	- cross-section of the conductor (mm ²)	6 mm²	—
	- test current (A) d.c.	4,1 A	—
	- voltage drop (mV) after short-time withstand current test not exceeding 3,2 mV	1 – 2,08 mV	P
	If the measured value exceeds 3,2 mV, the voltage drop is determined on each individual clamping unit separately, which shall not exceed 1,6 mV		N
	Test current from clamping unit to support (2-2)		
	- test current (A)	1 – 720 A 2 – 720 A 3 – 720 A	—
	- duration of the test current (s)	1 – 1 s 2 – 1 s 3 – 1 s	—

IEC 60947-7-2			
Clause	Requirement – Test	Result - Remark	Verdict
	At the end of the test, continuity shall exist on the test sample assembly and the terminal blocks shall not show any cracking, breakage or other critical damage		P
	Voltage drop after short-time withstand current test		
	- cross-section of the conductor (mm ²)	6 mm²	—
	- test current (A) d.c.	4,1 A	—
	- voltage drop (mV) after short-time withstand current test not exceeding 6,4 mV	1 – 1,54 mV	P
	If the measured value exceeds 6,4 mV, the voltage drop is determined on each individual clamping unit separately, which shall not exceed 4,8 mV		N
8.4.6	Short-time withstand current test type		
	- cross-section of the conductor (mm ²)	10 mm²	—
	- torque (Nm) clamping unit	-	—
	- rail profile and material	Top hat rail 35 mm	—
	- torque (Nm) clamping to support	-	—
	Test current from clamping unit to clamping unit (1-1)		
	- test current (A)	1 – 1200 A 2 – 1200 A 3 – 1200 A	—
	- duration of the test current (s)	1 – 1 s 2 – 1 s 3 – 1 s	—
	At the end of the test, continuity shall exist on the test sample assembly and the terminal blocks shall not show any cracking, breakage or other critical damage		P
	Voltage drop after short-time withstand current test		
	- cross-section of the conductor (mm ²)	10 mm²	—
	- test current (A) d.c.	5,7 A	—

IEC 60947-7-2			
Clause	Requirement – Test	Result - Remark	Verdict
	- voltage drop (mV) after short-time withstand current test not exceeding 3,2 mV	1,81 mV	P
	If the measured value exceeds 3,2 mV, the voltage drop is determined on each individual clamping unit separately, which shall not exceed 1,6 mV		N
	Test current from clamping unit to support (2-2)		
	- test current (A)	1 – 1200 A 2 – 1200 A 3 – 1200 A	—
	- duration of the test current (s)	1 – 1 s 2 – 1 s 3 – 1 s	—
	At the end of the test, continuity shall exist on the test sample assembly and the terminal blocks shall not show any cracking, breakage or other critical damage		P
	Voltage drop after short-time withstand current test		
	- cross-section of the conductor (mm ²)	10 mm²	—
	- test current (A) d.c.	5,7 A	—
	- voltage drop (mV) after short-time withstand current test not exceeding 6,4 mV	2,01 mV	P
	If the measured value exceeds 6,4 mV, the voltage drop is determined on each individual clamping unit separately, which shall not exceed 4,8 mV		N
8.4.7	Ageing test (for screwless-type terminal blocks only)		
	Maximum ambient temperature (°C)	40° C	—
	Rated cross-section solid or stranded (mm ²)	6 mm²	—
	Heating cabinet is increased, in each cycle to (°C)	85° C	—
	Test current (A) d.c. for measurement of the voltage drop	4,1 A	—

IEC 60947-7-2			
Clause	Requirement – Test	Result - Remark	Verdict
	Rail profile and material	Top hat rail 35 mm, Cu	—
	Torque (Nm) clamping to support	-	—
	Voltage drop after 0 cycles:		
	- requirement for clamping unit to clamping unit: ≤ 3,2 mV (mV)	1 – 1,40 mV 2 – 1,20 mV 3 – 1,50 mV 4 – 1,70 mV 5 – 1,80 mV	P
	If the measured value exceeds 3,2 mV, the voltage drop is determined on each individual clamping unit separately, which shall not exceed 1,6 mV		N
	- requirement for clamping unit to support: ≤ 6,4 mV (mV)	1 – 1,40 mV 2 – 1,70 mV	P
	If the measured value exceeds 6,4 mV, the voltage drop is determined on each individual clamping unit separately, which shall not exceed 4,8 mV		N
	Voltage drop after the 24th cycle:		
	- requirement for clamping unit to clamping unit: 4,8 mV (mV)	1 – 1,40 mV 2 – 1,20 mV 3 – 1,60 mV 4 – 1,70 mV 5 – 1,80 mV	P
	- requirement for clamping unit to support: 9,6 mV (mV)	1 – 1,60 mV 2 – 1,70 mV	P
	:		
	Voltage drop after the 48th cycle		

IEC 60947-7-2			
Clause	Requirement – Test	Result - Remark	Verdict
	- requirement for clamping unit to clamping unit: ≤ 4,8 mV or 1,5 times the value measured after the 24th cycle (mV)	1 – 1,40 mV 2 – 1,20 mV 3 – 1,60 mV 4 – 1,70 mV 5 – 1,80 mV	P
	- requirement for clamping unit to support: ≤ 9,6 mV or 1,5 times the value measured after the 24th cycle (mV)	1 – 1,60 mV 2 – 1,70 mV	P
	Voltage drop after the 72th cycle:		
	- requirement for clamping unit to clamping unit: ≤ 4,8 mV or 1,5 times the value measured after the 24th cycle (mV)	1 – 1,40 mV 2 – 1,20 mV 3 – 1,60 mV 4 – 1,70 mV 5 – 1,80 mV	P
	- requirement for clamping unit to support: ≤ 9,6 mV or 1,5 times the value measured after the 24th cycle (mV)	1 – 1,60 mV 2 – 1,70 mV	P
	Voltage drop after the 96th cycle:		
	- requirement for clamping unit to clamping unit: ≤ 4,8 mV or 1,5 times the value measured after the 24th cycle (mV)	1 – 1,40 mV 2 – 1,20 mV 3 – 1,60 mV 4 – 1,70 mV 5 – 1,80 mV	P
	- requirement for clamping unit to support: ≤ 9,6 mV or 1,5 times the value measured after the 24th cycle (mV)	1 – 1,60 mV 2 – 1,70 mV	P
	Voltage drop after the 120th cycle:		
	- requirement for clamping unit to clamping unit: ≤ 4,8 mV or 1,5 times the value measured after the 24th cycle (mV)	1 – 1,40 mV 2 – 1,20 mV 3 – 1,60 mV 4 – 1,70 mV 5 – 1,80 mV	P

IEC 60947-7-2			
Clause	Requirement – Test	Result - Remark	Verdict
	- requirement for clamping unit to support: ≤ 9,6 mV or 1,5 times the value measured after the 24th cycle (mV)	1 – 1,60 mV 2 – 1,70 mV	P
	Voltage drop after the 144th cycle:		
	- requirement for clamping unit to clamping unit: ≤ 4,8 mV or 1,5 times the value measured after the 24th cycle (mV)	1 – 1,40 mV 2 – 1,20 mV 3 – 1,60 mV 4 – 1,70 mV 5 – 1,80 mV	P
	- requirement for clamping unit to support: ≤ 9,6 mV or 1,5 times the value measured after the 24th cycle (mV)	1 – 1,60 mV 2 – 1,70 mV	P
	Voltage drop after the 168th cycle:		
	- requirement for clamping unit to clamping unit: ≤ 4,8 mV or 1,5 times the value measured after the 24th cycle (mV)	1 – 1,40 mV 2 – 1,20 mV 3 – 1,60 mV 4 – 1,70 mV 5 – 1,80 mV	P
	- requirement for clamping unit to support: ≤ 9,6 mV or 1,5 times the value measured after the 24th cycle (mV)	1 – 1,60 mV 2 – 1,70 mV	P
	Voltage drop after the 192th cycle:		
	- requirement for clamping unit to clamping unit: ≤ 4,8 mV or 1,5 times the value measured after the 24th cycle (mV)	1 – 1,40 mV 2 – 1,20 mV 3 – 1,60 mV 4 – 1,70 mV 5 – 1,80 mV	P
	- requirement for clamping unit to support: ≤ 9,6 mV or 1,5 times the value measured after the 24th cycle (mV)	1 – 1,60 mV 2 – 1,70 mV	P
	Pull-out test		
	force (N)	80 N	—

IEC 60947-7-2			
Clause	Requirement – Test	Result - Remark	Verdict
	1 min, the conductor shall neither slip out of the terminal nor break near the clamping unit		P
8.4.7	Ageing test (for screwless-type terminal blocks only)		
	Maximum ambient temperature (°C)	40° C	—
	Rated cross-section solid or stranded (mm ²)	10 mm²	—
	Heating cabinet is increased, in each cycle to (°C)	85° C	—
	Test current (A) d.c. for measurement of the voltage drop	5,7 A	—
	Rail profile and material	Top hat rail 35 mm, Cu	—
	Torque (Nm) clamping to support	-	—
	Voltage drop after 0 cycles:		
	- requirement for clamping unit to clamping unit: ≤ 3,2 mV (mV)	1 – 1,39 mV 2 – 1,34 mV 3 – 1,40 mV 4 – 1,42 mV 5 – 1,44 mV	P
	If the measured value exceeds 3,2 mV, the voltage drop is determined on each individual clamping unit separately, which shall not exceed 1,6 mV		N
	- requirement for clamping unit to support: ≤ 6,4 mV (mV)	1 – 2,27 mV 2 – 1,54 mV	P
	If the measured value exceeds 6,4 mV, the voltage drop is determined on each individual clamping unit separately, which shall not exceed 4,8 mV		N
	Voltage drop after the 24th cycle:		

IEC 60947-7-2			
Clause	Requirement – Test	Result - Remark	Verdict
	- requirement for clamping unit to clamping unit: 4,8 mV (mV)	1 – 1,48 mV 2 – 1,41 mV 3 – 1,45 mV 4 – 1,48 mV 5 – 1,46 mV	P
	- requirement for clamping unit to support: 9,6 mV (mV) :	1 – 2,20 mV 2 – 1,53 mV	P
	Voltage drop after the 48th cycle		
	- requirement for clamping unit to clamping unit: ≤ 4,8 mV or 1,5 times the value measured after the 24th cycle (mV)	1 – 1,51 mV 2 – 1,43 mV 3 – 1,47 mV 4 – 1,48 mV 5 – 1,45 mV	P
	- requirement for clamping unit to support: ≤ 9,6 mV or 1,5 times the value measured after the 24th cycle (mV)	1 – 2,25 mV 2 – 1,53 mV	P
	Voltage drop after the 72th cycle:		
	- requirement for clamping unit to clamping unit: ≤ 4,8 mV or 1,5 times the value measured after the 24th cycle (mV)	1 – 1,54 mV 2 – 1,44 mV 3 – 1,48 mV 4 – 1,49 mV 5 – 1,44 mV	P
	- requirement for clamping unit to support: ≤ 9,6 mV or 1,5 times the value measured after the 24th cycle (mV)	1 – 2,24 mV 2 – 1,53 mV	P
	Voltage drop after the 96th cycle:		
	- requirement for clamping unit to clamping unit: ≤ 4,8 mV or 1,5 times the value measured after the 24th cycle (mV)	1 – 1,55 mV 2 – 1,45 mV 3 – 1,48 mV 4 – 1,50 mV 5 – 1,44 mV	P

IEC 60947-7-2			
Clause	Requirement – Test	Result - Remark	Verdict
	- requirement for clamping unit to support: ≤ 9,6 mV or 1,5 times the value measured after the 24th cycle (mV)	1 – 2,25 mV 2 – 1,53 mV	P
	Voltage drop after the 120th cycle:		
	- requirement for clamping unit to clamping unit: ≤ 4,8 mV or 1,5 times the value measured after the 24th cycle (mV)	1 – 1,56 mV 2 – 1,46 mV 3 – 1,49 mV 4 – 1,50 mV 5 – 1,44 mV	P
	- requirement for clamping unit to support: ≤ 9,6 mV or 1,5 times the value measured after the 24th cycle (mV)	1 – 2,25 mV 2 – 1,53 mV	P
	Voltage drop after the 144th cycle:		
	- requirement for clamping unit to clamping unit: ≤ 4,8 mV or 1,5 times the value measured after the 24th cycle (mV)	1 – 1,57 mV 2 – 1,46 mV 3 – 1,49 mV 4 – 1,51 mV 5 – 1,44 mV	P
	- requirement for clamping unit to support: ≤ 9,6 mV or 1,5 times the value measured after the 24th cycle (mV)	1 – 2,25 mV 2 – 1,53 mV	P
	Voltage drop after the 168th cycle:		
	- requirement for clamping unit to clamping unit: ≤ 4,8 mV or 1,5 times the value measured after the 24th cycle (mV)	1 – 1,57 mV 2 – 1,43 mV 3 – 1,49 mV 4 – 1,51 mV 5 – 1,45 mV	P
	- requirement for clamping unit to support: ≤ 9,6 mV or 1,5 times the value measured after the 24th cycle (mV)	1 – 2,25 mV 2 – 1,53 mV	P
	Voltage drop after the 192th cycle:		

IEC 60947-7-2			
Clause	Requirement – Test	Result - Remark	Verdict
	- requirement for clamping unit to clamping unit: ≤ 4,8 mV or 1,5 times the value measured after the 24th cycle (mV)	1 – 1,58 mV 2 – 1,47 mV 3 – 1,49 mV 4 – 1,51 mV 5 – 1,45 mV	P
	- requirement for clamping unit to support: ≤ 9,6 mV or 1,5 times the value measured after the 24th cycle (mV)	1 – 2,25 mV 2 – 1,53 mV	P
	Pull-out test		
	force (N)	90 N	—
	1 min, the conductor shall neither slip out of the terminal nor break near the clamping unit		P
8.5	Verification of thermal characteristics are checked by the needle flame test		
	Before the test, the terminal blocks are stored for 24 h in an atmosphere having a temperature between 15°C and 35°C and a relative humidity between 45% and 75%		P
	The flame is applied for 10 s. for insulation walls <1 mm and / or an area < 100 mm ² , the flame is applied for 5 s.	10 s	P
	The terminal blocks are considered to have passed the test if the duration of burning is < 30s in case of ignition. Moreover, the tissue paper on the pinewood board shall not ignite if burning or glowing particles fall from the terminal block.		P
8.6	Verification of EMC characteristics		
	Subclause 8.4 of IEC 60947-1 applies with the following addition		N
8.6.1	Immunity		N

IEC 60947-7-2			
Clause	Requirement – Test	Result - Remark	Verdict
	Terminal blocks within the scope of this standard are not sensitive of electromagnetic disturbances and therefore no immunity tests are necessary.		N
8.6.2	Emission		N
	Terminal blocks within the scope of this standard do not generate electromagnetic disturbances and therefore no emission tests are necessary.		N

8.4.3	TABLE: Dielectric Strength		
Test voltage applied between:	Test potential applied (V)	Breakdown / flashover (Yes/No)	
1,3 and 5 to 2 and 4	2000 V	No	
All terminals to support	2000 V	No	
Supplementary information:			



8.4.3	TABLE: Dielectric Strength		
Test voltage applied between:	Test potential applied (V)	Breakdown / flashover (Yes/No)	
1,3 and 5 to 2 and 4	2200 Vac / 3820 Vdc	No	
All terminals to support	2200 Vac / 3820 Vdc	No	
Supplementary information:			

Product data

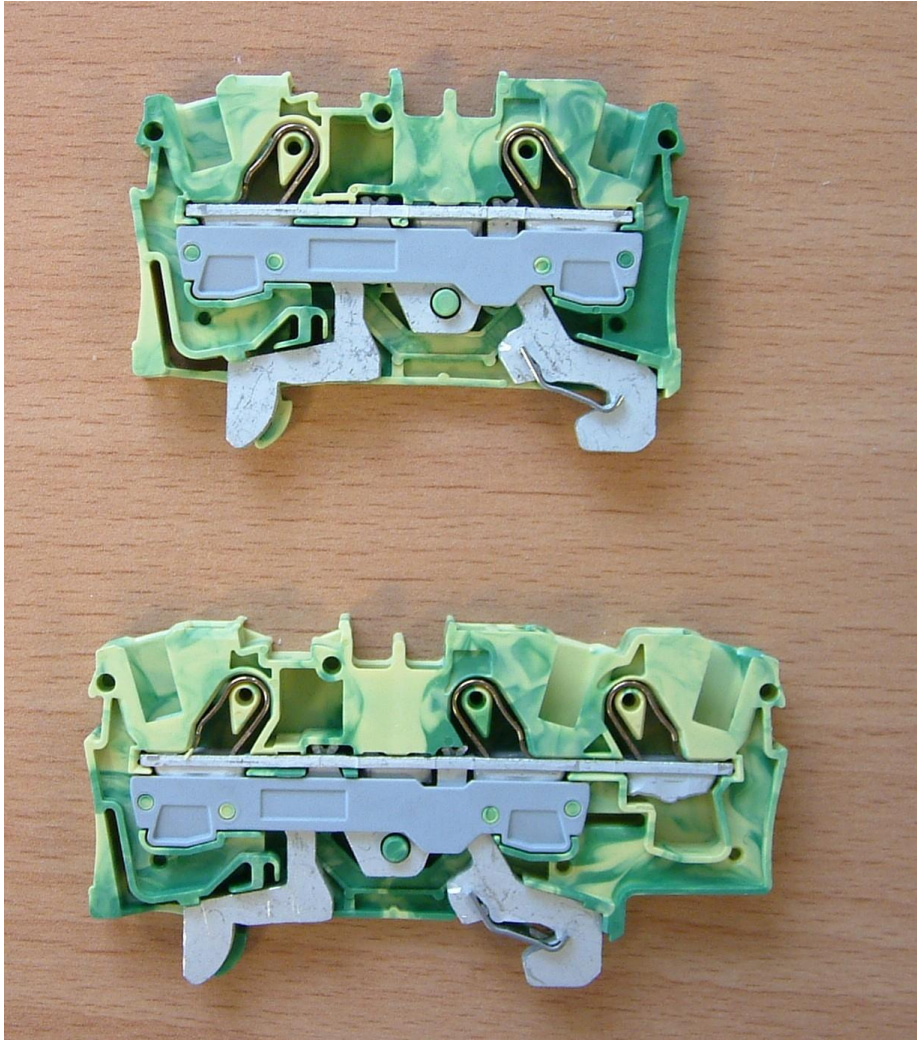
Product	: terminal blocks
Trade name(s)	: WAGO
Type(s)/model(s)	: TOPJOB S 2006
Material	: thermoplastic material
Rated connecting capacity	: 6 mm ² / 10 mm ² rigid and flexible
Connectable conductors	: 0,5 mm ² - 10 mm ² rigid and flexible
Method of mounting	: for mounting on top hat rail 35 mm
Type	: 2006-1207
Description	: 2 conductor earth terminal block, with screwless-type terminals, 1-pole
Type	: 2006-1307
Description	: 3 conductor earth terminal block, with screwless-type terminals, 1-pole



TEST REPORT SUMMARY

Report Reference No. : **2221172.52**
Date of issue..... : **2017-11-28**
Tested by (name + signature)..... : **H.L. Schendstok** 
Witnessed by (name + signature).... :
Approved by (name + signature)..... : **C.C. Burger** 
Supervised by (name + signature).... :

Testing Laboratory..... : **DEKRA Certification B.V.**
Address : **Meander 1051, 6825 MJ Arnhem, The Netherlands**
Testing procedure..... : ENEC/CCA-TL IEC/IEC-CBTL TMP WMT SMT
Testing location : **DEKRA Certification B.V.**
Address : **Meander 1051, 6825 MJ Arnhem, The Netherlands**

Applicant..... : **WAGO Kontakttechnik GmbH & Co. KG**
Address : **Hansastraße 27, 32423 Minden/Westfalen, Germany**
Manufacturer..... : **WAGO Kontakttechnik GmbH & Co. KG**
Address : **Hansastraße 27, 32423 Minden/Westfalen, Germany**

Product..... : **Rail mounted fuse terminal blocks**
Model/Type reference : **TOPJOB S 2006**
Trademark..... : **WAGO**
Ratings : **6 mm² or 10 mm², 800 V, 6 kV / 8 kV**

Certification Scheme..... : ENEC CCA Other: _____

Standard(s)..... : **IEC 60947-7-3:2009 (Second Edition)**

- The text of the a.m. European Standard was approved by CENELEC under the Unique Acceptance Procedure and is identical with the corresponding IEC Publication.
- The text of the a.m. European Standard was approved by CENELEC with agreed common modifications and is not identical with the corresponding IEC Publication.

This EN test report consists of the following parts:
 IEC TRF No.: IEC60947_7_3A Report Reference No..... : **2221172.52**
 CENELEC-Addendum Form No. Report Reference No. or Annex No...:

Copyright © 2013 EEPKA, Paris, France. All rights reserved.
 This ECS document together with the test report is only valid if signed by an approved ENEC or CCA Testing Laboratory and accompanied by the associated ENEC Licence or CCA Notification of Test Results, issued by a Certification Body member of ECS.



Test Report issued under the responsibility of:



TEST REPORT
IEC 60947-7-3
Low-voltage switchgear and controlgear
Part 7: Ancillary equipment
Section Three: Safety requirements for fuse terminal blocks

Report Reference No.....: 2221172.52
Date of issue: 2017-11-28
Total number of pages.....: 34

CB Testing Laboratory.....: DEKRA Certification B.V.
Address.....: Meander 1051, 6825 MJ Arnhem, The Netherlands

Applicant's name.....: WAGO Kontakttechnik GmbH & Co. KG
Address.....: Hansastrasse 27, 32423 Minden/Westfalen, Germany

Test specification:

Standard: IEC 60947-7-3:2009 (Second Edition)
Test procedure.....: CB scheme
Non-standard test method.....: N/A

Test Report Form No.....: IEC60947_7_3A
Test Report Form(s) Originator.....: KEMA Quality B.V.
Master TRF.....: Dated 2009-07



Copyright © 2009 IEC System for Conformity Testing and Certification of Electrical Equipment (IECEE), Geneva, Switzerland. All rights reserved.

This publication may be reproduced in whole or in part for non-commercial purposes as long as the IECEE is acknowledged as copyright owner and source of the material. IECEE takes no responsibility for and will not assume liability for damages resulting from the reader's interpretation of the reproduced material due to its placement and context.

If this Test Report Form is used by non-IECEE members, the IECEE/IEC logo and the reference to the CB Scheme procedure shall be removed.

This report is not valid as a CB Test Report unless signed by an approved CB Testing Laboratory and appended to a CB Test Certificate issued by an NCB in accordance with IECEE 02.

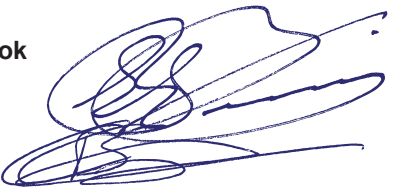
Test item description: Rail mounted fuse terminal blocks
Trade Mark.....: 
Manufacturer.....: WAGO Kontakttechnik GmbH & Co. KG
Model/Type reference.....: TOPJOB S 2006
Ratings.....: 6 mm² or 10 mm², 800 V, 6 kV / 8 kV
Factory location: WAGO Kontakttechnik GmbH & Co. KG
Hansastrasse 27, 32423 Minden/Westfalen Germany
See complete overview of factory locations: General product information

Testing procedure and testing location:	
<input checked="" type="checkbox"/> CB Testing Laboratory:	DEKRA Certification B.V.
Testing location/ address.....:	Meander 1051, 6825 MJ Arnhem, The Netherlands
Associated CB Laboratory:	
Testing location/ address.....:	
Tested by (name + signature).....:	H.L. Schendstok 
Approved by (+ signature)	C.C. Burger 
<input type="checkbox"/> Testing procedure: TMP	
Tested by (name + signature).....:	
Approved by (+ signature)	
Testing location/ address.....:	
<input type="checkbox"/> Testing procedure: WMT	
Tested by (name + signature).....:	
Witnessed by (+ signature)	
Approved by (+ signature)	
Testing location/ address.....:	
<input type="checkbox"/> Testing procedure: SMT	
Tested by (name + signature).....:	
Approved by (+ signature)	
Supervised by (+ signature).....:	
Testing location/ address.....:	
<input type="checkbox"/> Testing procedure: RMT	
Tested by (name + signature).....:	
Approved by (+ signature)	
Supervised by (+ signature).....:	
Testing location/ address.....:	

Summary of testing:	
Tests performed (name of test and test clause): <u>Project 2166989.52</u> Complete examination All tests are carried out at type 2006-1611 unless otherwise stated. <u>Project: 2173612.52</u> This Test Report replaces test Report 2166989.52 issued on 5 February 2014, due to the fact that types are added <u>Project 2221172.52</u> This Test Report replaces test Report 2173612.51 issued on 15 October 2014 due to the fact that types are added in test report 2221172.50.	Testing location: DEKRA certification B.V. Meander 1051, 6825 MJ Arnhem The Netherlands
Summary of compliance with National Differences: N/A	
<input checked="" type="checkbox"/> The product fulfils the requirements of EN 60947-7-3: 2009.	
Copy of marking plate Example: WAGO TOP JOB S 2006 2006-1631/1000-541 6 mm²	

Test item particulars :	
Classification of installation and use :	
Supply Connection :	
..... :	
..... :	
Possible test case verdicts:	
- test case does not apply to the test object..... :	N/A
- test object does meet the requirement..... :	P (Pass)
- test object does not meet the requirement :	F (Fail)
Testing :	
Date of receipt of test item :	2014-08
Date (s) of performance of tests :	2014-08
General remarks:	
<p>The test results presented in this report relate only to the object tested. This report shall not be reproduced, except in full, without the written approval of the Issuing testing laboratory. "(see Enclosure #)" refers to additional information appended to the report. "(see appended table)" refers to a table appended to the report.</p> <p>Throughout this report a comma (point) is used as the decimal separator.</p>	
General product information: see page 31-34	
Factory locations:	
<p>Wago Elwag sp.z.o.o. ul. Piekna 58 a, 50-506, Wroclaw Poland</p> <p>Wago & Controls (India) Ltd. C-27, Sector-58, Phase III, 201 301 Noida Gautam Bugh Nagar (U.P) India</p> <p>Wago Electronic (Tianjin) Co. Ltd. No. 5 Quanhui Road, 301700, Tianjin China</p> <p>WAGO Kontakttechnik GmbH & Co. KG Hansastrasse 27, 32423 Minden/Westfalen Germany</p> <p>WAGO Kontakttechnik GmbH & Co. KG, Werk Sondershausen Waldstrasse 1, 99706, Sondershausen Germany</p> <p>WAGO Contact S.A. Route de l'Industrie 19, CP 168, 1564, Domdidier Switzerland</p>	

Particulars: test item vs. test requirements

- method of fixing	mounting on top hat rail 35 mm
- number of poles.....	1 pole
- type of clamping units	screwless-type terminal
- ability to receive conductors	unprepared conductors, flexible or rigid
- number of terminals on terminal assembly.....	2
- type of fuse-carrier.....	plug in type
- rated power dissipation	
PV separate arrangement (W)	2,5 W
PV compound arrangement (W)	1,6 W
PVK separate arrangement (W)	2,5 W
PVK compound arrangement (W)	2,5 W
- rated cross-section (mm ²)	6 mm² and 10 mm²
- rated connecting capacity (mm ²)	0,5 – 10 mm² rigid and flexible
- rated insulation voltage (Ui).....	rated insulation voltage 800 V and working voltage determined by fuselink
- rated impulse withstand voltage (Uimp)	6 kV (internal)
	8 kV (adjacent)

IEC 60947-7-3			
Clause	Requirement – Test	Result - Remark	Verdict
5.1	MARKING		
	Fuse terminal block shall be marked with:		
	- manufacturer's name or trademark	WAGO	P
	- type designation	TOPJOB S 2006	P
	- energy flow direction (e.g. line-load or →)		N/A
5.2	The following information shall be stated by the manufacturer if applicable, e.g. in the manufacturer's data sheet, or his catalogue on the packing unit:		
	- manufacturer's claim for compliance with IEC 60 947-7-3	IEC 60947-7-3	P
	- rated cross-section	6 mm² or 10 mm²	P
	- rated connecting capacity	0,5 mm² - 10 mm²	P
	rated insulation voltage (U _i) terminal block base rated insulation voltage (U _i) fuse carrier	800 V	P
	- working voltage (range) determined by the fuselink		P
	- rated impulse withstand voltage (U _{imp})	6 kV (internal) 8 kV (adjacent)	P
	- rated value of the power dissipation (P _v) and rated current of the fuse-link: separate arrangement compound arrangement		P
	- rated value of the power dissipation (P _{vK}) and rated current of the fuse-link: separate arrangement compound arrangement		P
	- operating conditions, if different from clause 6.		P
	- size of the fuse-link.	5 x 20 mm 5 x 30 mm	P
5.3	Marking on the packing unit		
	- No overload protection		N/A
	- No overload protection in compound arrangement		N/A

IEC 60947-7-3			
Clause	Requirement – Test	Result - Remark	Verdict
7.	CONSTRUCTION		
7.1	Constructional requirements		
7.1.1	Clamping units		
7.1.7.1 60947-1	All parts of clamping units which maintain contact and carry current shall be of metal having adequate mechanical strength		P
	Clamping units connections shall be such that necessary contact pressure is maintained		P
	Clamping units shall be so constructed that the conductor is clamped between suitable surfaces without damage to the conductor and terminal		P
	Clamping units shall not allow the conductor to be displaced or to be displaced themselves in a manner detrimental to the operation of equipment and the insulation voltage shall not be reduced below the rated value		P
	Clamping units shall allow the conductor to be connected by means ensuring that a reliable mechanical linkage and electrical contact is properly maintained		P
	Clamping units shall be able to withstand the forces that can be applied through the connected conductors		P
	Contact pressure is not transmitted through insulation materials		P
7.1.2	Mounting		
	Terminal blocks shall be provided with means that allow them to be securely attached to a rail or a mounting surface (see 8.3.2)		P
7.1.3	Clearances and creepage distances		
	Clearances and creepage distances are designed for overvoltage category III and pollution degree 3		P

IEC 60947-7-3			
Clause	Requirement – Test	Result - Remark	Verdict
	Clearances and creepage distances are checked when assembled for normal use, e.g. fuse carrier no.3 or no. 6 is inserted	no.3	P
	Conductor type and conductor cross-section	rigid 10	—
	Conductor end length (mm)	13 – 15 mm	—
	Type of support	top hat rail 35 mm	—
	a) Functional insulation		
	- insulation between live parts with different potential		P
	- insulation between live parts of adjacent fuse terminal blocks of same series and size		P
	b) Basic insulation		
	- insulation between live parts and fixing support		
	Clearances	(internal) (adjacent)	
	Case B (mm)	5 mm 3 mm	P
	Case A (mm)	5,5 mm 8 mm	
	Measured (mm)	7,94 mm 11,6 mm	
	Rated impulse withstand voltage	6 kV 8 kV	P
	Creepage distances:		
	- pollution degree	3	—
	- comparative tracking index (V)	600 V	—
	- material group	I	—
	- rated insulation voltage Ui (V)	250 V	—
	- minimum creepage distances (mm)	3,2 mm	—
	- measured creepage distances (mm)	7,94 mm	—
	Creepage distances: (adjacent)		
	- pollution degree	2	—
	- comparative tracking index (V)	600 V	—
	- material group	I	—
	- rated insulation voltage Ui (V)	800 V	—
	- minimum creepage distances (mm)	10 mm	—
	- measured creepage distances (mm)	11,6	—
7.1.4	Terminal identification and marking:		

IEC 60947-7-3			
Clause	Requirement – Test	Result - Remark	Verdict
	- terminal intended exclusively for the neutral conductor		P
	- other terminals		P
	- terminal blocks shall have provision, or at least space, for identification marks or numbers for each terminal or terminal assembly to be related to the circuit of which it is to form a part		P
7.1.5	Void		
7.1.6	Rated cross-section and rated connecting capacity		
	Terminal blocks are so designed that conductors of the rated cross-section and/or the rated connecting capacity can be accepted	0,5 mm – 10 mm² rigid and flexible	P
7.1.7	Void		
7.1.8	Actuating conditions		
	Live parts of a fuse terminal block are not accessible when it is assembled, installed and operated under normal conditions		P
	Safety from finger touch of live parts of the fuse-carrier is ensured during replacement of the fuse-link		P

8	TESTS		
8.3	Verification of mechanical characteristics		
8.3.2	Attachment of the terminal block on its support		
	mounting rail	Top hat rail 35 mm	—
	Tightening torque (Nm)	screwless	—
	steel pin diameter (mm)	1 mm	—
	force (N)	1 N	—
	During the test, no terminal block shall work free from its rail or support, nor suffer any other damage		P
8.3.3	Mechanical properties of clamping units of a fuse terminal block		

IEC 60947-7-3			
Clause	Requirement – Test	Result - Remark	Verdict
8.3.3.1	Testing of mechanical strength of clamping units		
8.2.4.2 60947-1	Mechanical strength of clamping units		
	rated cross-section of a rigid conductor (mm ²) ... :	6 mm² or 10 mm²	—
	diameter of thread (mm)	screwless	—
	torque (Nm)	screwless	—
	5 times on 2 clamping units at the centre terminal block out of 5 terminal blocks		P
8.3.3.2	Testing for damage to and accidental loosening of conductor (flexion test)		
8.3.3.3	Pull out test		
	conductor of the smallest cross-section (mm ²) ... :	0,5 mm² rigid and flexible	—
	number of conductor of the smallest cross-section	1	—
	diameter of bushing hole (mm)	6,5 mm	—
	height between the equipment and the platen (mm)	260 mm	—
	mass at the conductor(s) (kg)	0,3 kg	—
	135 continuous revolutions: the conductor shall neither slip out of the terminal nor break near the clamping unit		
	Pull-out test		
	force (N)	30 N	—
	1 min, the conductor shall neither slip out of the terminal nor break near the clamping unit		
	conductor of the rated cross-section (mm ²)	6 mm²	—
	number of conductor of the rated cross-section .. :	1	—
	diameter of bushing hole (mm)	9,5 mm	—
	height between the equipment and the platen (mm)	280 mm	—
	mass at the conductor(s) (kg)	1,4 kg	—
	135 continuous revolutions: the conductor shall neither slip out of the terminal nor break near the clamping unit		P

IEC 60947-7-3			
Clause	Requirement – Test	Result - Remark	Verdict
	Pull-out test		
	force (N) :	80 N	—
	1 min, the conductor shall neither slip out of the terminal nor break near the clamping unit		P
	conductor of the largest cross-section (mm ²) :	10 mm²	—
	number of conductor of the largest cross-section :	1	—
	diameter of bushing hole (mm) :	9,5 mm	—
	height between the equipment and the platen (mm) :	280 mm	—
	mass at the conductor(s) (kg) :	2 kg	—
	135 continuous revolutions: the conductor shall neither slip out of the terminal nor break near the clamping unit		P
	Pull-out test		
	force (N) :	90 N	—
	1 min, the conductor shall neither slip out of the terminal nor break near the clamping unit		P
	conductor of the largest or smallest cross-section (mm ²) :		—
	number of conductor of the largest or smallest cross-section :		—
	diameter of bushing hole (mm) :		—
	height between the equipment and the platen (mm) :		—
	mass at the conductor(s) (kg) :		—
	135 continuous revolutions: the conductor shall neither slip out of the terminal nor break near the clamping unit		N/A
	Pull-out test		
	force (N) :		—
	1 min, the conductor shall neither slip out of the terminal nor break near the clamping unit		N/A
8.3.3.4	Verification of rated cross section and rated connecting capacity		

IEC 60947-7-3			
Clause	Requirement – Test	Result - Remark	Verdict
	One conductor of the two next smaller cross-sections can be unhindered and connected in each clamping unit of one terminal block (up to 35 mm ²)	(6 mm²) or (10 mm²) 2,5 mm² or 4 mm²	P
8.3.4	Compatibility between fuse terminal blocks and the fuse-link		
	The maximum gauge No. 1 or gauge No. 4 in accordance with table A.1 is inserted and withdrawn 10 times from the fuse-carrier	no. 1	P
	Following each insertion of the gauge, the fuse-carrier is fitted to the terminal block base as in normal operation		P
	For fuse terminal blocks with screw-type fuse carrier, the fuse carrier is fitted with a torque of two-thirds of the value specified in table 1 (Nm)		P
	- No visible damage - No loosening of parts - In the most unfavourable position, the minimum gauge No. 2 or gauge No. 5 will not fall from the fuse-carrier in the most unfavourable position. or fuse terminal blocks with screw-type fuse carrier, the fuse carrier is fitted with a torque of two-thirds of the value specified in table 1 (Nm)		P
8.4.4	Contact resistance:		
	Measurement carried out in direct or alternating current	a.c. / d.c 0,1 A	—
	rated frequency (Hz) by alternating current	-	—
	Gauge no.2 or no. 5 inserted	2	—
	Screw-type fuse-carrier is tightened with a torque of two-thirds of the value in table 1: (Nm)		N/A
	Plug-on type or hinged-type fuse-carrier is installed as in normal use		P
	measuring cycle with d.c.		
	a) insertion of gauge in the fuse-holder		P
	b) measurement with current flowing in one direction		P

IEC 60947-7-3			
Clause	Requirement – Test	Result - Remark	Verdict
	c) measurement with current flowing in opposite direction		P
	d) removal of the gauge from the fuse-holder		P
	Measuring cycle with a.c.		
	a) insertion of the gauge in the fuse-holder		N/A
	b) measurement		N/A
	c) removal of the gauge from the fuse-holder		N/A
	Measuring values	See table I	P
	The mean value of the contact resistance shall not exceed 10 mΩ		P
	The individual value of the contact resistance shall not exceed 15 mΩ		P
8.3.5	Mechanical strength of the connection between the terminal block base and the fuse-carrier		
8.3.5.1	Torque test on screw-type fuse-carriers		
	The fuse-carrier is equipped with the maximum gauge no. 1 or no. 4.		N/A
	The fuse-carrier was screwed five times into the terminal block with torque: (Nm):		N/A
	The fuse-carrier is securely kept in the terminal block base during and after the test and show no changes impairing its normal use		N/A
8.3.5.2	Pull-out test on screw-type and bayonet-type fuse-carrier		
	The fuse-is carrier equipped with the maximum gauge no. 1 or no. 4.		N/A
	Screw-type fuse-carrier is tightened with a torque of two-thirds of the value in table A.1: (Nm)		N/A
	Axial pulling force for 1 min. to the fuse-carrier (N)		N/A
	The fuse-carrier is securely kept in the terminal block base during and after the test and show no changes impairing its normal use		N/A

IEC 60947-7-3			
Clause	Requirement – Test	Result - Remark	Verdict
8.3.5.3	Actuating forces on plug-on type or hinged-type fuse-carriers		
	The fuse-carrier together with the maximum gauge No. 1 or gauge No. 4 was inserted in and withdrawn from the fuse-base, 10 times	no . 1	P
	Actuating forces assigned by the manufacturer	Insertion forces: 15 N to 25 N Withdrawal forces: 45 N to 55 N assigned by the manufacturer	P
	The value of any individual measurement was within the limits assigned by the manufacturer	Measured insertion forces: 15,2 N to 21,4 N Measured withdrawal forces: 46,2 N to 54,2 N	P
	The fuse-carrier is securely kept in the terminal block base during and after the test and show no changes impairing its normal use		N/A
8.4	Verification of electrical characteristics		
8.4.3	Dielectric tests		
	- five terminal blocks connected with unfavourable cross-section (mm ²) /type/ conductor end length (mm)	10 mm² rigid 13 – 15 mm	—
	- type of most unfavourable support.....	Top hat rail 35 mm	—
	Dielectric test, Uimp indicated:		
	Test A		
	- Gauge no.3 or no. 6 inserted	no.3	—
	- rated impulse withstand voltage (V)	6 kV	—
	- test Uimp (kV)	7,3 kV	P
	- rated insulation voltage (V)	250 V	—
	- test voltage for 5 sec (V)	1500 V	P
	Test B		
	- Gauge no.1 or no. 4 inserted	no.1	—
	- rated impulse withstand voltage (V)	8 kV	—

IEC 60947-7-3			
Clause	Requirement – Test	Result - Remark	Verdict
	- test Uimp (kV)	9,8 kV	P
	- rated insulation voltage (V)	800 V	—
	- test voltage for 5 sec (V)	2000 V	P
8.4.4	Contact resistance:		
	Measurement carried out in direct or alternating current	a.c. / d.c. 0,1 A	—
	rated frequency (Hz) by alternating current	-	—
	Gauge no.2 or no. 5 inserted	2	—
	Screw-type fuse-carrier is tightened with a torque of two-thirds of the value in table 1: (Nm)		N/A
	Plug-on type or hinged-type fuse-carrier is installed as in normal use		P
	measuring cycle with d.c.		
	a) insertion of gauge in the fuse-holder		P
	b) measurement with current flowing in one direction		P
	c) measurement with current flowing in opposite direction		P
	d) removal of the gauge from the fuse-holder		P
	Measuring cycle with a.c.		
	a) insertion of the gauge in the fuse-holder		N/A
	b) measurement		N/A
	c) removal of the gauge from the fuse-holder		N/A
	Measuring values	See table II	
	The mean value of the contact resistance shall not exceed 10 mΩ		P
	The individual value of the contact resistance shall not exceed 15 mΩ		P
8.4.5	Temperature rise of clamping unit		
	Five terminal blocks are installed side by side with gauge no.2 or no. 5	no.2	P
	- test current (A)	10 A	—
	- cross-section of the conductor (mm ²)	1,5 mm²	—

IEC 60947-7-3			
Clause	Requirement – Test	Result - Remark	Verdict
	- insulation colour of conductor black	black	
	- torque (Nm)	-	—
	- temperature rise of the conductor clamping unit does not exceed 45 K	10 K – 12 K	P
8.4.6	Void		
8.4.7	Ageing test (for screwless-type fuse terminal blocks only)		
	Five adjacent terminal blocks equipped with gauge no.2 or no. 5	2	P
	- cross-section of the conductor (mm ²)	1,5 mm²	—
	Maximum ambient temperature (°C)	40 °C	—
	Contact resistance		
	Measurement carried out in direct or alternating current	a.c. / d.c. 0,1 A	—
	rated frequency (Hz) by alternating current	-	—
	Screw-type fuse-carrier is tightened with a torque of two-thirds of the value in table 1: (Nm)		N/A
	Plug-on type or hinged-type fuse-carrier is installed as in normal use		P
	measuring cycle with d.c.		
	a) insertion of gauge in the fuse-holder		P
	b) measurement with current flowing in one direction		P
	c) measurement with current flowing in opposite direction		P
	d) removal of the gauge from the fuse-holder		
	Measuring cycle with a.c.		P
	a) insertion of the gauge in the fuse-holder		N/A
	b) measurement		N/A
	c) removal of the gauge from the fuse-holder		N/A
	Heating cabinet is increased, in each cycle to (°C)	40 °C	—
	Contact resistance after 0 cycles:		

IEC 60947-7-3			
Clause	Requirement – Test	Result - Remark	Verdict
	- requirement: $\leq 15 \text{ m}\Omega$ (m Ω)	1 – 2,1 m Ω 2 – 2,2 m Ω 3 – 2,1 m Ω 4 – 2,3 m Ω 5 – 2,0 m Ω	P
	Voltage drop after the 24th cycle:		
	- requirement: $\leq 15 \text{ m}\Omega$ (m Ω)	1 – 2,2 m Ω 2 – 2,3 m Ω 3 – 2,1 m Ω 4 – 2,3 m Ω 5 – 2,1 m Ω	P
	Voltage drop after the 48th cycle		
	- requirement: $\leq 15 \text{ m}\Omega$ or 1,5 times the value measured after the 24th cycle (m Ω)	1 – 2,2 m Ω 2 – 2,3 m Ω 3 – 2,1 m Ω 4 – 2,3 m Ω 5 – 2,1 m Ω	P
	Voltage drop after the 72nd cycle:		
	- requirement: $\leq 4,8 \text{ mV}$ or 1,5 times the value measured after the 24th cycle (m Ω)	1 – 2,2 m Ω 2 – 2,3 m Ω 3 – 2,1 m Ω 4 – 2,3 m Ω 5 – 2,1 m Ω	P
	Voltage drop after the 96th cycle:		
	- requirement: $\leq 15 \text{ m}\Omega$ or 1,5 times the value measured after the 24th cycle (m Ω)	1 – 2,2 m Ω 2 – 2,3 m Ω 3 – 2,1 m Ω 4 – 2,3 m Ω 5 – 2,1 m Ω	P
	Voltage drop after the 120th cycle:		

IEC 60947-7-3			
Clause	Requirement – Test	Result - Remark	Verdict
	- requirement: $\leq 15 \text{ m}\Omega$ or 1,5 times the value measured after the 24th cycle (m Ω)	1 – 2,2 m Ω 2 – 2,3 m Ω 3 – 2,1 m Ω 4 – 2,3 m Ω 5 – 2,1 m Ω	P
	Voltage drop after the 144th cycle:		
	- requirement: $\leq 15 \text{ m}\Omega$ or 1,5 times the value measured after the 24th cycle (m Ω)	1 – 2,2 m Ω 2 – 2,3 m Ω 3 – 2,1 m Ω 4 – 2,3 m Ω 5 – 2,1 m Ω	P
	Voltage drop after the 168th cycle:		
	- requirement: $\leq 15 \text{ m}\Omega$ or 1,5 times the value measured after the 24th cycle (m Ω)	1 – 2,2 m Ω 2 – 2,2 m Ω 3 – 2,1 m Ω 4 – 2,3 m Ω 5 – 2,1 m Ω	P
	Voltage drop after the 192nd cycle:		
	- requirement: $\leq 15 \text{ m}\Omega$ or 1,5 times the value measured after the 24th cycle (m Ω)	1 – 2,2 m Ω 2 – 2,2 m Ω 3 – 2,1 m Ω 4 – 2,3 m Ω 5 – 2,1 m Ω	P
	Visual inspection show no changes impairing further use such as cracks, deformations or the like		P
	Pull-out test		
	force (N)	40 N	—
	1 min, the conductor shall neither slip out of the terminal nor break near the clamping unit		P
8.5	Verification of thermal characteristics		P
8.5.2	Rated power dissipation		P

IEC 60947-7-3			
Clause	Requirement – Test	Result - Remark	Verdict
8.5.2.2	Test arrangement for the overload and short-circuit protection		
8.5.2.2.1	Separate arrangement	For derating see graphic I	P
	Central terminal with dummy fuse-link of the power dissipation value Pv1 (W)	2,5 W	—
	- cross-section of the conductor (mm ²)	1 mm²	—
	- torque (Nm)	-	—
	hottest point of the insulating part of the fuse terminal block (TS2) max K (assigned by the manufacturer)	75,4 K	—
	Surface of actuating element (TS1) max 62 K	33,7 K	P
8.5.2.2.2	Compound arrangement	For derating see graphic II	P
	Five terminal blocks shall be installed on a support as in normal use.		P
	- cross-section of the conductor (mm ²) :	1 mm²	—
	- torque (Nm)	screwless	—
	The fuse terminal blocks shall be equipped with dummy fuse-links of the maximum power dissipation value Pv2 and central terminal with dummy fuse-link of the power dissipation value Pv1 (W).....	Pv1 1,6 W Pv2 0,7 W	—
	hottest point of the insulating part of the fuse terminal block (TS2) max K (assigned by the manufacturer)	73,8 K	—
	Surface of actuating element (TS1) max 62 K	39,8 K	P
8.5.2.3	Test arrangement for exclusive short-circuit protection		
8.5.2.3.1	Separate arrangement	For derating see graphic III	
	Central terminal with dummy fuse-link of the power dissipation value Pv2 (W)	1 W	—
	- cross-section of the conductor (mm ²)	1 mm²	—

IEC 60947-7-3			
Clause	Requirement – Test	Result - Remark	Verdict
	- torque (Nm)	-	—
	hottest point of the insulating part of the fuse terminal block (TS2) max K (assigned by the manufacturer)	37,5 K	—
	Surface of actuating element (TS1) max 62 K	18,5 K	P
8.5.2.3.2	Compound arrangement	For derating see graphic IV	P
	Five terminal blocks shall be installed on a support as in normal use.		P
	- cross-section of the conductor (mm ²).....	1 mm²	—
	- torque (Nm).....		—
	The fuse terminal blocks shall be equipped with dummy fuse-links of the maximum power dissipation value Pv2 (W)	1 W	—
	hottest point of the insulating part of the fuse terminal block (TS2) max K (assigned by the manufacturer)	61,7 K	—
	Surface of actuating element (TS1) max 62 K	34,5 K	P
8.5.3	Durability		
	Fuse terminal blocks shall be resistant to heat and mechanical stresses which are liable to occur in normal use	2,5 W	P
	The fuse terminal block shall be subjected to the test for separate arrangement according to 8.5.2.2.1 or 8.5.2.3.1, as applicable.		P
	The test shall be carried out continuously over a period of 168 h.		P

IEC 60947-7-3			
Clause	Requirement – Test	Result - Remark	Verdict
8.4.3	Dielectric tests		
	- five terminal blocks connected with unfavourable cross-section (mm ²) /type/ conductor end length (mm)	10 mm² rigid 13 – 15 mm	—
	- type of most unfavourable support.....	Top hat rail 35 mm	—
	Dielectric test, Uimp indicated:		
	Test A		
	- Gauge no.3 or no. 6 inserted	no.3	—
	- rated impulse withstand voltage (V)	6 kV	—
	- test Uimp (kV)	7,3 kV	p
	- rated insulation voltage (V)	250 V	—
	- test voltage for 5 sec (V)	1500 V	p
	Test B		
	- Gauge no.1 or no. 4 inserted	no.1	—
	- rated impulse withstand voltage (V)	8 kV	—
	- test Uimp (kV)	9,8 kV	
	- rated insulation voltage (V)	800 V	—
	- test voltage for 5 sec (V)	2000 V	
8.4.4	Contact resistance:		
	Measurement carried out in direct or alternating current	a.c. / d.c. 0,1 A	—
	rated frequency (Hz) by alternating current	-	—
	Gauge no.2 or no. 5 inserted	2	—
	Screw-type fuse-carrier is tightened with a torque of two-thirds of the value in table 1: (Nm)		N
	Plug-on type or hinged-type fuse-carrier is installed as in normal use		P
	measuring cycle with d.c.		
	a) insertion of gauge in the fuse-holder		P

IEC 60947-7-3			
Clause	Requirement – Test	Result - Remark	Verdict
	b) measurement with current flowing in one direction		P
	c) measurement with current flowing in opposite direction		P
	d) removal of the gauge from the fuse-holder		P
	Measuring cycle with a.c.		
	a) insertion of the gauge in the fuse-holder		N
	b) measurement		N
	c) removal of the gauge from the fuse-holder		N
	Measuring values	See table III	N
	The mean value of the contact resistance shall not exceed 10 mΩ		P
	The individual value of the contact resistance shall not exceed 15 mΩ		P
8.3.4	Compatibility between fuse terminal blocks and the fuse-link		
	The maximum gauge No. 1 or gauge No. 4 in accordance with table A.1 is inserted and withdrawn 10 times from the fuse-carrier	no.1	P
	Following each insertion of the gauge, the fuse-carrier is fitted to the terminal block base as in normal position		P
	For fuse terminal blocks with screw-type fuse carrier, the fuse carrier is fitted with a torque of two-thirds of the value specified in table 1 (Nm)		N
	- No visible damage - No looseing of parts - In the most unfavourable position, the minimum gauge No. 2 or gauge No. 5 is not fall from the fuse-carrier in the most unfavourable position.or fuse terminal blocks with screw-type fuse carrier, the fuse carrier is fitted with a torque of two-thirds of the value specified in table 1 (Nm)	no.2	P
8.4.4	Contact resistance:		

IEC 60947-7-3			
Clause	Requirement – Test	Result - Remark	Verdict
	Measurement carried out in direct or alternating current	a.c. / d.c. 0,1 A	—
	rated frequency (Hz) by alternating current	-	—
	Gauge no.2 or no. 5 inserted	no.2	—
	Screw-type fuse-carrier is tightened with a torque of two-thirds of the value in table 1: (Nm)		N
	Plug-on type or hinged-type fuse-carrier is installed as in normal use		P
	measuring cycle with d.c.		
	a) insertion of gauge in the fuse-holder		P
	b) measurement with current flowing in one direction		P
	c) measurement with current flowing in opposite direction		P
	d) removal of the gauge from the fuse-holder		P
	Measuring cycle with a.c.		
	a) insertion of the gauge in the fuse-holder		N/A
	b) measurement		N/A
	c) removal of the gauge from the fuse-holder		N/A
	Measuring values	See table IV	
	The mean value of the contact resistance shall not exceed 10 mΩ		P
	The individual value of the contact resistance shall not exceed 15 mΩ		P
8.5.4	Needle flame test		
	Before the test, the terminal blocks are stored for 24 h in an atmosphere having a temperature between 15°C and 35°C and a relative humidity between 45% and 75%		P
	The flame is applied for 10s. for insulation walls <1 mm and/or an area <100 mm ² , the flame is applied for 5 s.		P

IEC 60947-7-3			
Clause	Requirement – Test	Result - Remark	Verdict
	<p>The terminal blocks are considered to have passed the test if the duration of burning is < 30s in case of ignition.</p> <p>Moreover, the tissue paper on the pinewood board shall not ignite if burning or glowing particles fall from the terminal block.</p>		P
8.6	Verification of EMC characteristics		N
	Subclause 8.4 of IEC 60947-1 applies with the following addition		N
8.6.1	Immunity		
	Terminal blocks within the scope of this standard are not sensitive of electromagnetic disturbances and therefore no immunity tests are necessary.		N
8.6.2	Emission		N
	Terminal blocks within the scope of this standard do not generate electromagnetic disturbances and therefore no emission tests are necessary.		N

Remarks

Table I: contact resistance after compatibility between fuse terminal blocks and fuse-links, clause 8.3.4

cycle	sample 1		sample 2		sample 3		sample 4		sample 5	
	one direction for d.c. or a.c. (mΩ)	other direction for d.c. only (mΩ)	one direction for d.c. or a.c. (mΩ)	other direction for d.c. only (mΩ)	one direction for d.c. or a.c. (mΩ)	other direction for d.c. only (mΩ)	one direction for d.c. or a.c. (mΩ)	other direction for d.c. only (mΩ)	one direction for d.c. or a.c. (mΩ)	other direction for d.c. only (mVΩ)
1	1,91	1,94	2,01	1,91	2,10	2,01	1,74	1,78	1,90	1,88
2	1,68	1,69	1,42	1,58	1,82	1,80	1,79	1,82	1,74	1,71
3	1,99	2,01	1,67	1,96	2,50	2,44	1,71	1,76	1,92	1,88
4	1,84	1,82	1,67	1,91	2,22	2,17	1,81	1,82	1,81	1,78
5	1,78	1,74	2,01	2,02	1,95	1,90	1,86	1,89	1,80	1,84

Table II: contact resistance, clause 8.4.4

cycle	sample 1		sample 2		sample 3		sample 4		sample 5	
	one direction for d.c. or a.c. (mΩ)	other direction for d.c. only (mΩ)	one direction for d.c. or a.c. (mΩ)	other direction for d.c. only (mΩ)	one direction for d.c. or a.c. (mΩ)	other direction for d.c. only (mΩ)	one direction for d.c. or a.c. (mΩ)	other direction for d.c. only (mΩ)	one direction for d.c. or a.c. (mΩ)	other direction for d.c. only (mΩ)
1	2,15	2,13	1,74	1,76	1,90	1,91	1,64	1,68	2,01	2,05
2	2,18	2,16	1,78	1,79	1,92	1,94	1,66	1,70	1,99	2,01
3	2,21	2,18	1,82	1,84	1,89	1,91	1,63	1,70	1,89	1,92
4	2,17	2,17	1,80	1,84	1,86	1,88	1,65	1,77	1,94	1,96
5	2,14	2,10	1,77	1,80	1,84	1,86	1,64	1,69	2,02	2,01

Table III: contact resistance after durability, clause 8.5.3

cycle	sample 1		sample 2		sample 3		sample 4		sample 5	
	one direction for d.c. or a.c. (mΩ)	other direction for d.c. only (mΩ)	one direction for d.c. or a.c. (mΩ)	other direction for d.c. only (mΩ)	one direction for d.c. or a.c. (mΩ)	other direction for d.c. only (mΩ)	one direction for d.c. or a.c. (mΩ)	other direction for d.c. only (mΩ)	one direction for d.c. or a.c. (mΩ)	other direction for d.c. only (mΩ)
1	1,76	1,70	2,01	2,03	1,81	1,89	1,80	1,78	1,68	1,71
2	1,63	1,58	1,98	2,04	1,74	1,79	1,74	1,76	1,72	1,75
3	1,74	1,78	1,91	1,88	1,69	1,74	1,78	1,84	1,70	1,76
4	1,82	1,89	1,89	1,86	1,72	1,78	1,82	1,86	1,76	1,78
5	1,86	1,84	1,94	1,96	1,74	1,68	1,86	1,88	1,81	1,84

Table IV: compatibility between fuse terminal block and fuse link after durability, clause 8.5.3

Remarks

cycle	sample 1		sample 2		sample 3		sample 4		sample 5	
	one direction for d.c. or a.c. (mΩ)	other direction for d.c. only (mΩ)	one direction for d.c. or a.c. (mΩ)	other direction for d.c. only (mΩ)	one direction for d.c. or a.c. (mΩ)	other direction for d.c. only (mΩ)	one direction for d.c. or a.c. (mΩ)	other direction for d.c. only (mΩ)	one direction for d.c. or a.c. (mΩ)	other direction for d.c. only (mΩ)
1	2,15	2,16	1,51	1,63	1,89	1,87	1,74	1,76	1,90	1,92
2	2,31	2,29	1,57	1,62	1,82	1,85	1,76	1,74	1,96	1,94
3	2,20	2,16	1,56	1,61	1,81	1,78	1,78	1,75	1,88	1,91
4	2,26	2,23	1,62	1,67	1,84	1,81	1,76	1,72	1,86	1,90
5	2,19	2,16	1,59	1,61	1,86	1,82	1,71	1,68	1,85	1,94

Graphic I overload and short-circuit protection

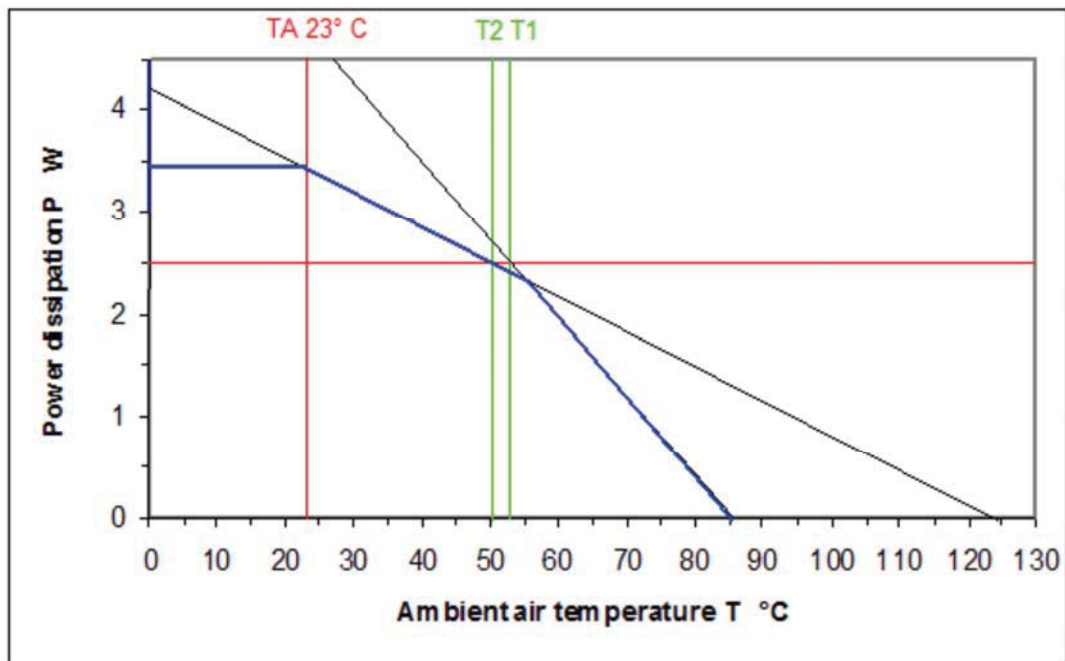

Remarks

Graphic II overload and short-circuit protection

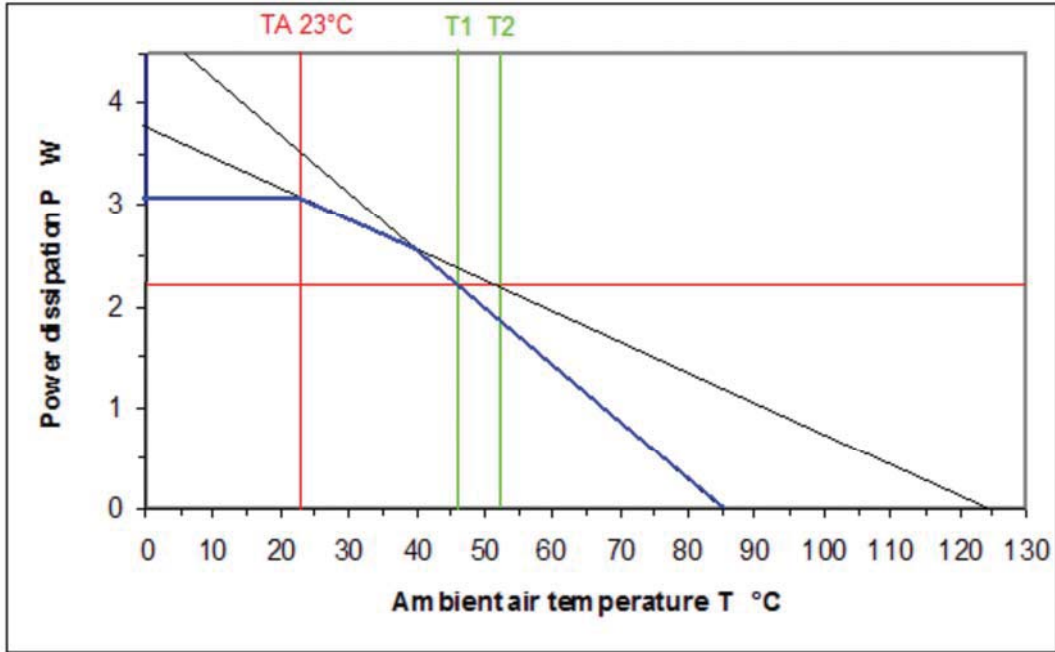

Graphic III for exclusive short-circuit protection

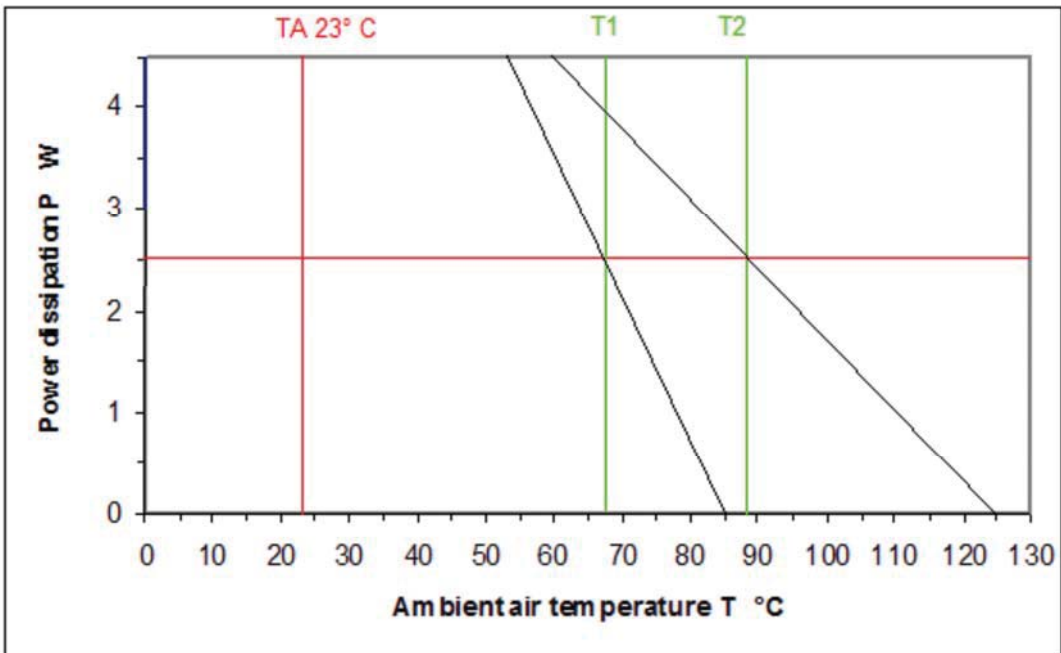

Graphic IV for exclusive short-circuit protection

Remarks

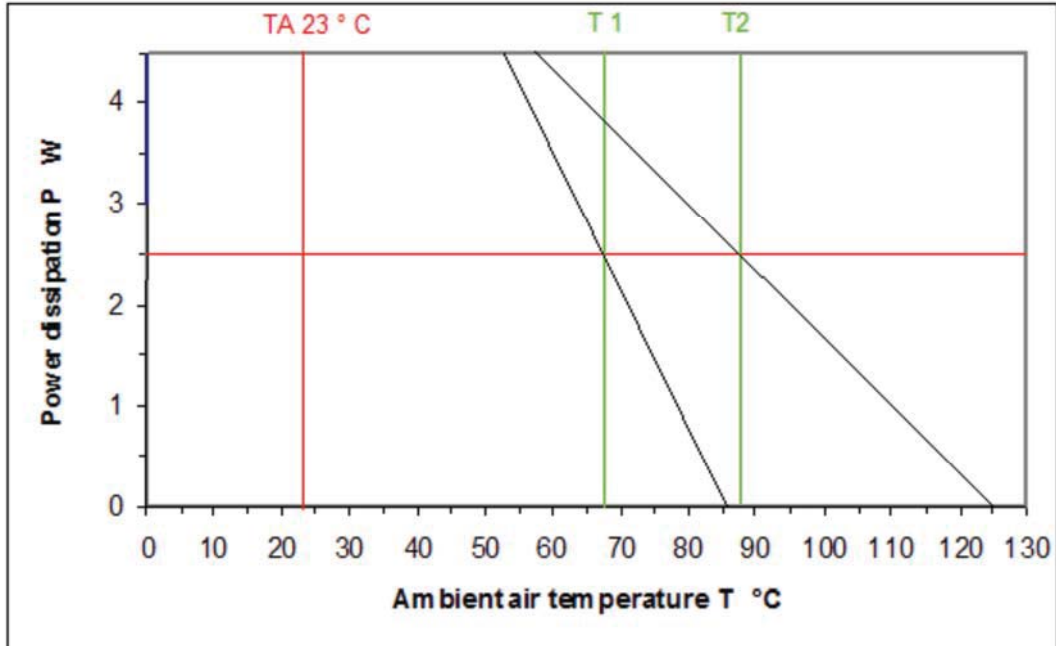

Remarks

Additional test for terminal blocks provided with indicator lights

Construction:

The indicator light (LED) is not removable.

The power dissipation in normal use in the series resistor exceed not the rated power dissipation, see table below.

type	rated voltage (V)	power dissipation (W)	
		DC	AC
2006-1621/1000-0859	500 V	0,480	-
2006-1621/1000-0541	30 V	0,084	-
2006-1621/1000-0542	65 V	0,17	-
2006-1621/1000-0836	230 V	0,102	-
2006-1631/100-0867	120 V	0,083	

Dielectric test (additional test)

The indicator light-circuit was subjected, for 1 second, to an ac voltage equal to twice the rated voltage of the indicator light. No flashover or breakdown occur, and neither the lamp nor its resistor were defective.

type	rated voltage (V)	Test voltage (V)
2006-1621/1000-0859	500 V	1000 V
2006-1621/1000-0541	30 V	60 V
2006-1621/1000-0836	230 V	460 V
2006-1631/1000-0867	120 V	240 V

Remarks

Temperature-rise test (normal)

The indicator light was connected to 1,06 times the rated voltage until steady temperature was reached. The maximal measured temperature-rise.

type	rated voltage (V)	Test voltage (V)	Temperature-rise (K)
2006-1621/1000-0859	500 V	530 V	72,3 K
2006-1621/1000-0541	30 V	31,8 V	29,4 K
2006-1621/1000-0542	65 V	68,9 V	60,4 K
2006-1621/1000-0836	230 V	243,8 V	58,3 K
2006-1631/1000-0867	120 V	127,2 V	23,3 K

Temperature-rise test (abnormal)

The indicator light was connected to the rated voltage until steady temperature was reached. The LED was short-circuit, because the clearances and creepage distances of the indicator light are smaller than the required distances in the EN 60947-1. The maximal measured temperature-rise.

type	rated voltage (V)	Test voltage (V)	Temperature-rise (K)
2006-1621/1000-0859	500 V	500 V	50,6 K
2006-1621/1000-0541	30 V	30 V	29,4 K
2006-1621/1000-0542	65 V	65 V	25,6 K
2006-1621/1000-0836	230 V	230 V	43,6 K
2006-1631/1000-0867	120 V	120 V	21,7 K

Remarks

Product data

Product : terminal blocks
 Trade name(s) : WAGO
 Type(s)/model(s) : TOPJOB S 2006
 Material : thermoplastic material
 Rated connecting capacity : 6 mm² / 10 mm² rigid and flexible
 Connectable conductors : 0,5 mm² - 10 mm² rigid and flexible
 Method of mounting : for mounting on top hat rail 35 mm

Current : 10 A (6 mm²)
 Rated voltage : 800 V
 Rated impulse withstand voltage : 8 kV (adjacent terminal block)
 6 kV (internal)

Type : 2006 with suffixes -1611, -1612, -1613, -1614, -1615
 with optional suffixes
 / 1000-541; 12-30 V
 / 1000-542; 30-65 V
 / 1000-836; 230 V
 / 1000-859; 380-500 V
 / 1000-867; 120 V

Description : 2 conductor fuse disconnect terminal block with pivoting
 fuseholder, with screwless type terminals, fuse size 5x20 mm,
 1-pole

 exclusive short circuit protection:
 separate arrangement: PvK 2,5W
 compound arrangement: PvK 2,5W

 overload and short circuit protection:
 separate arrangement: Pv 2,5 W
 compound arrangement: Pv 1,6 W

Type : 2006 with suffixes -1621, -1622, -1623, 1624
 with optional suffixes
 / 1000-541; 12-30 V
 / 1000-542; 30-65 V
 / 1000-836; 230 V
 / 1000-859; 380-500 V
 / 1000-867; 120 V

Description : 2 conductor fuse disconnect terminal block with pivoting
 fuseholder, with screwless type terminals, fuse size 5x30 mm,
 1-pole

Remarks

exclusive short circuit protection:
separate arrangement: PvK 2,5W
compound arrangement: PvK 2,5W

overload and short circuit protection:
separate arrangement: Pv 2,5 W
compound arrangement: Pv 1,6 W

Current	: 10 A (6 mm ²)
Voltage	: 800 V
Fuse size	: 5x30 mm
Type	: 2006 with suffixes -1631, -1632, -1633, -1634 additional suffixes / 0099-0000 / 1000-541; 12-30 V / 1000-542; 30-65 V / 1000-836; 230 V / 1000-859; 380-500 V / 1000-867; 120 V / 1099-541; 12-30 V / 1099-542; 30-65 V / 1099-836; 230 V / 1099-859; 380-500 V / 1099-867; 120 V
Description	: 2 conductor fuse disconnect terminal block with pivoting fuse holder, with screwless type terminals, fuse size 1/4 x 1 1/4, 1 pole exclusive short circuit protection: separate arrangement: PvK 2,5 W compound arrangement: PvK 2,5 W overload and short circuit protection separate arrangement: Pv 2,5 W compound arrangement: Pv 1,6 W

Remarks

Current : 10 A (6 mm²)
Rated voltage : 800 V
Fuse size : 1/4 x 1 1/4
Type : 2006-911 with suffixes
/1000-541 (12 V - 30 V)
/1000-542 (30 V - 65 V)
/1000-867 (120 V)
/1000-836 (230 V)
Description : fuse plug with pull tab suffixes provided with indicator light

Current : 10 A
Rated voltage : 800 V
Fuse size : 5x30 mm
Type : 2006-921 with suffixes
/1000-541 (12 V - 30 V)
/1000-542 (30 V - 65 V)
/1000-867 (120 V)
/1000-836 (230 V)
/1000-859 (380 V - 500 V)
Description : fuse plug with pull tab provided with indicator light

Remarks

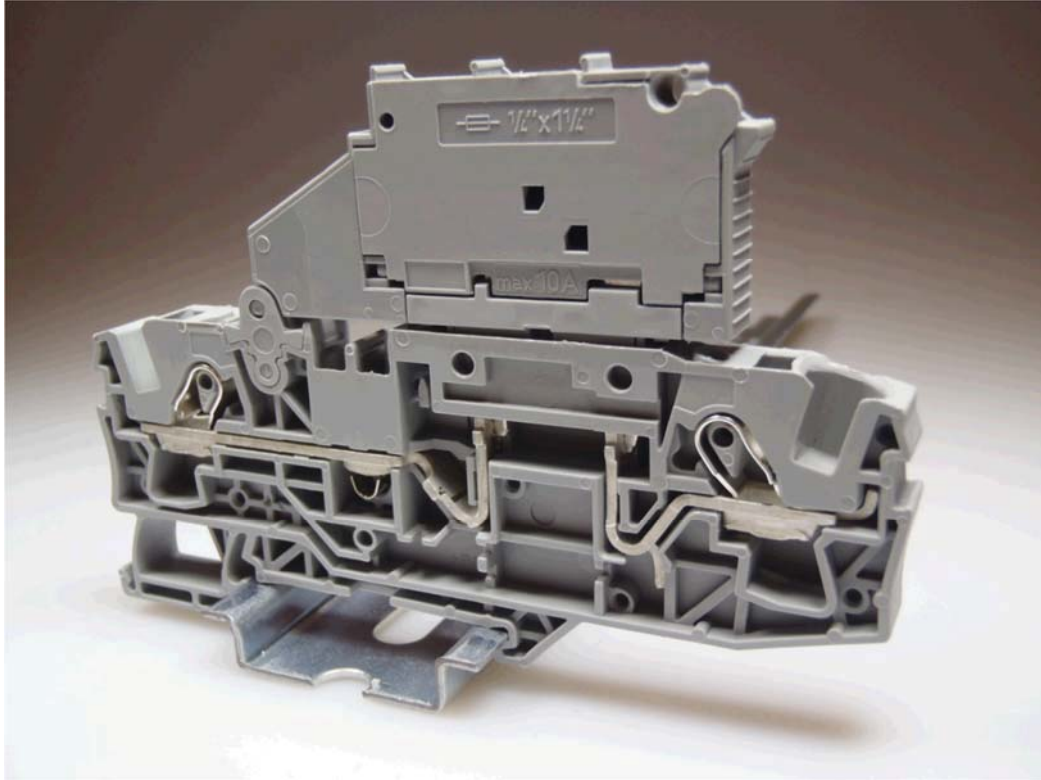

TEST REPORT SUMMARY

Report Reference No. : **2221172.53**
Date of issue..... : **2017-11-28**
Tested by (name + signature)..... : **H.L. Schendstok**
Witnessed by (name + signature).... :
Approved by (name + signature)..... : **C.C. Burger**
Supervised by (name + signature)... :

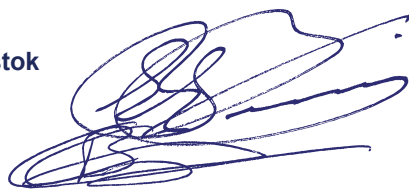

Testing Laboratory..... : **DEKRA Certification B.V.**
Address : **Meander 1051, 6825 MJ Arnhem, The Netherlands**
Testing procedure..... : ENEC/CCA-TL IEC/IEC-CBTL TMP WMT SMT
Testing location : **DEKRA Certification B.V.**
Address : **Meander 1051, 6825 MJ Arnhem, The Netherlands**

Applicant..... : **WAGO Kontakttechnik GmbH & Co. KG**
Address : **Hansastraße 27, 32423 Minden/Westfalen, Germany**
Manufacturer..... : **WAGO Kontakttechnik GmbH & Co. KG**
Address : **Hansastraße 27, 32423 Minden/Westfalen, Germany**

Product..... : **Rail mounted fuse terminal blocks**
Model/Type reference : **TOPJOB S 2006**
Trademark..... : **WAGO**
Ratings : **6 mm² or 10 mm², 500 V, 4 kV / 8 kV**

Certification Scheme..... : ENEC CCA Other: _____

Standard(s)..... : **IEC 60947-7-3:2009 (Second Edition)**

- The text of the a.m. European Standard was approved by CENELEC under the Unique Acceptance Procedure and is identical with the corresponding IEC Publication.
- The text of the a.m. European Standard was approved by CENELEC with agreed common modifications and is not identical with the corresponding IEC Publication.

This EN test report consists of the following parts:
 IEC TRF No.: IEC60947_7_3A Report Reference No..... : **2221172.53**
 CENELEC-Addendum Form No. Report Reference No. or Annex No...:

Copyright © 2013 EEPKA, Paris, France. All rights reserved.
 This ECS document together with the test report is only valid if signed by an approved ENEC or CCA Testing Laboratory and accompanied by the associated ENEC Licence or CCA Notification of Test Results, issued by a Certification Body member of ECS.



Test Report issued under the responsibility of:



TEST REPORT IEC 60947-7-3 Low-voltage switchgear and controlgear Part 7: Ancillary equipment Section Three: Safety requirements for fuse terminal blocks	
Report Reference No.....	2221172.53
Date of issue	2017-11-28
Total number of pages.....	31
CB Testing Laboratory.....	DEKRA Certification B.V.
Address.....	Meander 1051, 6825 MJ Arnhem, The Netherlands
Applicant's name.....	WAGO Kontakttechnik GmbH & Co. KG
Address.....	Hansastraße 27, 32423 Minden/Westfalen, Germany
Test specification:	
Standard	IEC 60947-7-3:2009 (Second Edition)
Test procedure.....	CB scheme
Non-standard test method.....	N/A
Test Report Form No.....	IEC60947_7_3A
Test Report Form(s) Originator.....	KEMA Quality B.V.
Master TRF.....	Dated 2009-07
<p>Copyright © 2009 IEC System for Conformity Testing and Certification of Electrical Equipment (IECEE), Geneva, Switzerland. All rights reserved.</p> <p>This publication may be reproduced in whole or in part for non-commercial purposes as long as the IECEE is acknowledged as copyright owner and source of the material. IECEE takes no responsibility for and will not assume liability for damages resulting from the reader's interpretation of the reproduced material due to its placement and context.</p> <p>If this Test Report Form is used by non-IECEE members, the IECEE/IEC logo and the reference to the CB Scheme procedure shall be removed.</p> <p>This report is not valid as a CB Test Report unless signed by an approved CB Testing Laboratory and appended to a CB Test Certificate issued by an NCB in accordance with IECEE 02.</p>	
Test item description	Rail mounted fuse terminal blocks
Trade Mark.....	
Manufacturer.....	WAGO Kontakttechnik GmbH & Co. KG
Model/Type reference.....	TOPJOB S 2006
Ratings.....	6 mm ² or 10 mm ² , 500 V, 4 kV / 8 kV
Factory location	WAGO Kontakttechnik GmbH & Co. KG Hansastraße 27, 32423 Minden/Westfalen Germany See complete overview of factory locations: General product information

Testing procedure and testing location:	
<input checked="" type="checkbox"/> CB Testing Laboratory:	DEKRA Certification B.V.
Testing location/ address.....:	Meander 1051, 6825 MJ Arnhem, The Netherlands
Associated CB Laboratory:	
Testing location/ address.....:	
Tested by (name + signature).....:	H.L. Schendstok 
Approved by (+ signature)	C.C. Burger
<input type="checkbox"/> Testing procedure: TMP	
Tested by (name + signature).....:	
Approved by (+ signature)	
Testing location/ address.....:	
<input type="checkbox"/> Testing procedure: WMT	
Tested by (name + signature).....:	
Witnessed by (+ signature)	
Approved by (+ signature)	
Testing location/ address.....:	
<input type="checkbox"/> Testing procedure: SMT	
Tested by (name + signature).....:	
Approved by (+ signature)	
Supervised by (+ signature).....:	
Testing location/ address.....:	
<input type="checkbox"/> Testing procedure: RMT	
Tested by (name + signature).....:	
Approved by (+ signature)	
Supervised by (+ signature).....:	
Testing location/ address.....:	

Summary of testing:	
Tests performed (name of test and test clause): <u>Project: 2166989.53</u> Complete examination All tests carried out on types 2006-1681 with fuse 25 A / 32 V unless otherwise stated According to the manufacturers instruction the continuous current of this fuse type is 80% of the current a.e (25 x 80% = 20 A) <u>Project 2221172.53</u> This Test Report replaces test Report 2166989.53 issued on 5 February 2014 due to the fact that types are added in test report 2218551.50.	Testing location: DEKRA certification B.V. Meander 1051, 6825 MJ Arnhem The Netherlands
Summary of compliance with National Differences: N/A <input checked="" type="checkbox"/> The product fulfils the requirements of EN 60947-7-3: 2009.	
Copy of marking plate WAGO TOPJOB S 2006 IEC 60947-7-1 500 V, 6 mm	

Test item particulars :	
Classification of installation and use	
Supply Connection	
.....	
.....	
Possible test case verdicts:	
- test case does not apply to the test object..... :	N/A
- test object does meet the requirement..... :	P (Pass)
- test object does not meet the requirement	F (Fail)
Testing :	
Date of receipt of test item	12-2013
Date (s) of performance of tests	12-2013
General remarks:	
<p>The test results presented in this report relate only to the object tested. This report shall not be reproduced, except in full, without the written approval of the Issuing testing laboratory. "(see Enclosure #)" refers to additional information appended to the report. "(see appended table)" refers to a table appended to the report.</p> <p>Throughout this report a comma (point) is used as the decimal separator.</p>	
General product information: see page 30-31	
Factory locations:	
<p>Wago Elwag sp.z.o.o. ul. Piekna 58 a, 50-506, Wroclaw Poland</p> <p>Wago & Controls (India) Ltd. C-27, Sector-58, Phase III, 201 301 Noida Gautam Bugh Nagar (U.P) India</p> <p>Wago Electronic (Tianjin) Co. Ltd. No. 5 Quanhui Road, 301700, Tianjin China</p> <p>WAGO Kontakttechnik GmbH & Co. KG Hansastrasse 27, 32423 Minden/Westfalen Germany</p> <p>WAGO Kontakttechnik GmbH & Co. KG, Werk Sondershausen Waldstrasse 1, 99706, Sondershausen Germany</p> <p>WAGO Contact S.A. Route de l'Industrie 19, CP 168, 1564, Domdidier Switzerland</p>	

Particulars: test item vs. test requirements	
- method of fixing	mounting on top hat rail 35 mm
- number of poles.....	1 pole
- type of clamping units	screwless-type terminal
- ability to receive conductors	unprepared conductors, flexible or rigid
- number of terminals on terminal assembly.....	2
- type of fuse-carrier.....	plug in type
- rated power dissipation	
PV separate arrangement (W)	
PV compound arrangement (W)	
PVK separate arrangement (W)	Non standard dummy fuse
PVK compound arrangement (W)	Non standard dummy fuse
- rated cross-section (mm ²)	6 mm² and 10 mm²
- rated connecting capacity (mm ²)	0,5 – 10 mm² rigid and flexible
- rated insulation voltage (U _i).....	rated insulation voltage 500 V and working voltage determined by fuselink
- rated impulse withstand voltage (U _{imp})	4 kV (internal) 8 kV (adjacent)

IEC 60947-7-3			
Clause	Requirement – Test	Result - Remark	Verdict
5.1	MARKING		
	Fuse terminal block shall be marked with:		
	- manufacturer's name or trademark	WAGO	P
	- type designation	TOPJOB S 2006	P
	- energy flow direction (e.g. line-load or →)		N
5.2	The following information shall be stated by the manufacturer if applicable, e.g. in the manufacturer's data sheet, or his catalogue on the packing unit:		
	- manufacturer's claim for compliance with EN 60 947-7-3	IEC 60947-7-1	P
	- rated cross-section	6 mm² or 10 mm²	P
	- rated connecting capacity	0,2 mm² - 10 mm² rigid and flexible	P
	rated insulation voltage (Ui) terminal block base rated insulation voltage (Ui) fuse carrier	500 V	P
	- working voltage (range) determined by the fuselink	determined by fuse link or electronic components	P
	- rated impulse withstand voltage (Uimp)	4 kV (internal) 8 kV (adjacent)	P
	- rated value of the power dissipation (Pv) and rated current of the fuse-link: separate arrangement compound arrangement		N
	- rated value of the power dissipation (PvK) and rated current of the fuse-link: separate arrangement compound arrangement	Non standard dummy fuse	P
	- operating conditions, if different from clause 6.		
	- size of the fuse-link.	automotive fuse	P
5.3	Marking on the packing unit		
	- No overload protection		P

IEC 60947-7-3			
Clause	Requirement – Test	Result - Remark	Verdict
	- No overload protection in compound arrangement		N

7.	CONSTRUCTION		
7.1	Constructional requirements		
7.1.1	Clamping units		
7.1.7.1 60947-1	All parts of clamping units which maintain contact and carry current shall be of metal having adequate mechanical strength		P
	Clamping units connections shall be such that necessary contact pressure is maintained		P
	Clamping units shall be so constructed that the conductor is clamped between suitable surfaces without damage to the conductor and terminal		P
	Clamping units shall not allow the conductor to be displaced or to be displaced themselves in a manner detrimental to the operation of equipment and the insulation voltage shall not be reduced below the rated value		P
	Clamping units shall allow the conductor to be connected by means ensuring that a reliable mechanical linkage and electrical contact is properly maintained		P
	Clamping units shall be able to withstand the forces that can be applied through the connected conductors		P
	Contact pressure is not transmitted through insulation materials		P
7.1.2	Mounting		
	Terminal blocks shall be provided with means that allow them to be securely attached to a rail or a mounting surface (see 8.3.2)		P

IEC 60947-7-3			
Clause	Requirement – Test	Result - Remark	Verdict
7.1.3	Clearances and creepage distances		
	Clearances and creepage distances are designed for overvoltage category III and pollution degree 3		P
	Clearances and creepage distances are checked when assemblies for normal use, e.g. fuse carrier no.3 or no. 6 is inserted	Non standard dummy fuse-link	P
	Conductor type and conductor cross-section	rigid 10 mm²	—
	Conductor end length (mm)	13 – 15 mm	—
	Type of support	Top hat rail 35 mm	—
	a) Functional insulation		
	- insulation between live parts with different potential		P
	- insulation between live parts of adjacent fuse terminal blocks of same series and size		P
	b) Basic insulation		
	- insulation between live parts and fixing support		
	Clearances	(internal) (adjacent)	
	Case B (mm)	1,2 mm 3 mm	P
	Case A (mm)	3 mm 8 mm	
	Measured (mm)	3,96 mm 7,14 mm	
	Rated impulse withstand voltage	4 kV 8 kV	P
	Creepage distances: (internal, fuse without meltwire)		
	- pollution degree	3	—
	- comparative tracking index (V)	600 V	—
	- material group	I	—
	- rated insulation voltage Ui (V)	32 V	—
	- minimum creepage distances (mm)	1,3 mm	—
	- measured creepage distances (mm)	3,96 mm	—
	Creepage distances: (adjacent)		
	- pollution degree	3	—

IEC 60947-7-3			
Clause	Requirement – Test	Result - Remark	Verdict
	- comparative tracking index (V)	600 V	—
	- material group	I	—
	- rated insulation voltage U_i (V)	500 V	—
	- minimum creepage distances (mm)	6,3 mm	—
	- measured creepage distances (mm)	> 10 mm	—
7.1.4	Terminal identification and marking:		
	- terminal intended exclusively for the neutral conductor		P
	- other terminals		P
	- terminal blocks shall have provision, or at least space, for identification marks or numbers for each terminal or terminal assembly to be related to the circuit of which it is to form a part		P
7.1.5	Void		
7.1.6	Rated cross-section and rated connecting capacity		
	Terminal blocks are so designed that conductors of the rated cross-section and/or the rated connecting capacity can be accepted	0,5 mm² – 10 mm² rigid and flexible	P
7.1.7	Void		
7.1.8	Actuating conditions		
	Live parts of a fuse terminal block are not accessible when it is assembled, installed and operated under normal conditions		P
	Safety from finger touch of live parts of the fuse-carriers ensured during replacement of the fuse-link		P

8	TESTS		
8.3	Verification of mechanical characteristics		
8.3.2	Attachment of the terminal block on its support		
	mounting rail	Top hat rail 35 mm	—

IEC 60947-7-3			
Clause	Requirement – Test	Result - Remark	Verdict
	Tightening torque (Nm)	-	—
	steel pin diameter (mm)	2,8 mm	—
	force (N)	5 N	—
	During the test, no terminal block shall work free from its rail or support, nor suffer any other damage		P
8.3.3	Mechanical properties of clamping units of a fuse terminal block		
8.3.3.1	Testing of mechanical strength of clamping units		
8.2.4.2	Mechanical strength of clamping units		
60947-1			
	rated cross-section of a rigid conductor (mm ²) ...	10 mm²	—
	diameter of thread (mm)	-	—
	torque (Nm)	-	—
	5 times on 2 clamping units at the centre terminal block out of 5 terminal blocks		P
8.3.3.2	Testing for damage to and accidental loosening of conductor (flexion test)		
8.3.3.3	Pull out test		
	conductor of the smallest cross-section (mm ²) ...	0,5 mm² rigid and flexible	—
	number of conductor of the smallest cross-section	1	—
	diameter of bushing hole (mm)	6,5 mm	—
	height between the equipment and the platen (mm)	260 mm	—
	mass at the conductor(s) (kg)	0,3 kg	—
	135 continuous revolutions: the conductor shall neither slip out of the terminal nor break near the clamping unit		P
	Pull-out test		
	force (N)	30 N	—
	1 min, the conductor shall neither slip out of the terminal nor break near the clamping unit		P

IEC 60947-7-3			
Clause	Requirement – Test	Result - Remark	Verdict
	conductor of the rated cross-section (mm ²) :	6 mm²	—
	number of conductor of the rated cross-section .. :	1	—
	diameter of bushing hole (mm) :	9,5 mm	—
	height between the equipment and the platen (mm) :	280 mm	—
	mass at the conductor(s) (kg) :	1,4 kg	—
	135 continuous revolutions: the conductor shall neither slip out of the terminal nor break near the clamping unit		P
	Pull-out test		
	force (N) :	80 N	—
	1 min, the conductor shall neither slip out of the terminal nor break near the clamping unit		P
	conductor of the largest cross-section (mm ²) :	10 mm²	—
	number of conductor of the largest cross-section :	1	—
	diameter of bushing hole (mm) :	9,5 mm	—
	height between the equipment and the platen (mm) :	280 mm	—
	mass at the conductor(s) (kg) :	2 kg	—
	135 continuous revolutions: the conductor shall neither slip out of the terminal nor break near the clamping unit		P
	Pull-out test		
	force (N) :	90 N	—
	1 min, the conductor shall neither slip out of the terminal nor break near the clamping unit		P
	conductor of the largest or smallest cross-section (mm ²) :		—
	number of conductor of the largest or smallest cross-section :		—
	diameter of bushing hole (mm) :		—

IEC 60947-7-3							
Clause	Requirement – Test	Result - Remark	Verdict				
	height between the equipment and the platen (mm)		—				
	mass at the conductor(s) (kg)		—				
	135 continuous revolutions: the conductor shall neither slip out of the terminal nor break near the clamping unit		N				
	Pull-out test						
	force (N)		—				
	1 min, the conductor shall neither slip out of the terminal nor break near the clamping unit		N				
8.3.3.4	Verification of rated cross section and rated connecting capacity						
	One conductor of the two next smaller cross-sections can be unhindered and connected in each clamping unit of one terminal block (up to 35 mm ²)	<table border="0"> <tr> <td>(6 mm²)</td> <td>(10 mm²)</td> </tr> <tr> <td>2,5 mm²</td> <td>4 mm²</td> </tr> </table>	(6 mm²)	(10 mm²)	2,5 mm²	4 mm²	P
(6 mm²)	(10 mm²)						
2,5 mm²	4 mm²						
8.3.4	Compatibility between fuse terminal blocks and the fuse-link						
	The maximum gauge No. 1 or gauge No. 4 in accordance with table A.1 is inserted and withdrawn 10 times from the fuse-carrier	Non standard dummy fuse	P				
	Following each insertion of the gauge, the fuse-carrier is fitted to the terminal block base as in normal operation		P				
	For fuse terminal blocks with screw-type fuse carrier, the fuse carrier is fitted with a torque of two-thirds of the value specified in table 1 (Nm)		N				

IEC 60947-7-3			
Clause	Requirement – Test	Result - Remark	Verdict
	- No visible damage - No loosening of parts - In the most unfavourable position, the - minimum gauge No. 2 or gauge No. 5 will not fall from the fuse-carrier in the most unfavourable position. or fuse terminal blocks with screw-type fuse carrier, the fuse carrier is fitted with a torque of two-thirds of the value specified in table 1 (Nm)	Non standard dummy fuse	P
8.4.4	Contact resistance:		
	Measurement carried out in direct or alternating current	a.c. / d.c 0,1 A	—
	rated frequency (Hz) by alternating current	-	—
	Gauge no.2 or no. 5 inserted	Non standard dummy fuse	—
	Screw-type fuse-carrier is tightened with a torque of two-thirds of the value in table 1: (Nm)		N
	Plug-on type or hinged-type fuse-carrier is installed as in normal use		P
	measuring cycle with d.c.		
	a) insertion of gauge in the fuse-holder		P
	b) measurement with current flowing in one direction		P
	c) measurement with current flowing in opposite direction		P
	d) removal of the gauge from the fuse-holder		P
	Measuring cycle with a.c.		
	a) insertion of the gauge in the fuse-holder		N
	b) measurement		N
	c) removal of the gauge from the fuse-holder		N
	Measuring values	See table I	N
	The mean value of the contact resistance shall not exceed 10 mΩ		P
	The individual value of the contact resistance shall not exceed 15 mΩ		P

IEC 60947-7-3			
Clause	Requirement – Test	Result - Remark	Verdict
8.3.5	Mechanical strength of the connection between the terminal block base and the fuse-carrier		
8.3.5.1	Torque test on screw-type fuse-carriers		
	The fuse-carrier is equipped with the maximum gauge no. 1 or no. 4.		N
	The fuse-carrier was screwed five times into the terminal block with torque: (Nm):		N
	The fuse-carrier is securely kept in the terminal block base during and after the test and show no changes impairing its normal use		N
8.3.5.2	Pull-out test on screw-type and bayonet-type fuse-carrier		
	The fuse-is carrier equipped with the maximum gauge no. 1 or no. 4.		N
	Screw-type fuse-carrier is tightened with a torque of two-thirds of the value in table A.1: (Nm)		N
	Axial pulling force for 1 min. to the fuse-carrier (N)		N
	The fuse-carrier is securely kept in the terminal block base during and after the test and show no changes impairing its normal use		N
8.3.5.3	Actuating forces on plug-on type or hinged-type fuse-carriers		
	The fuse-carrier together with the maximum gauge No. 1 or gauge No. 4 was inserted in and withdrawn from the fuse-base, 10 times	Non standard dummy fuse	P
	Actuating forces assigned by the manufacturer	Insertion forces: 14 N to 40 N Withdrawal forces: 10 N to 35 N assigned by the manufacturer	P
	The value of any individual measurement was	Measured insertion forces:	P

IEC 60947-7-3			
Clause	Requirement – Test	Result - Remark	Verdict
	within the limits assigned by the manufacturer	14 N to 35,6 N Measured withdrawal forces: 11 N to 31 N	
	The fuse-carrier is securely kept in the terminal block base during and after the test and show no changes impairing its normal use		P
8.4	Verification of electrical characteristics		
8.4.3	Dielectric tests		
	- five terminal blocks connected with unfavourable cross-section (mm ²) /type/ conductor end length (mm)	10 mm² rigid 13 mm – 15 mm	—
	- type of most unfavourable support.....	Top hat rail 35 mm	—
	Dielectric test, Uimp indicated:		
	Test A		
	- Gauge no.3 or no. 6 inserted	(fuse without meltwire)	—
	- rated impulse withstand voltage (V)	4 kV	—
	- test Uimp (kV)	4,8 kV	P
	- rated insulation voltage (V)	32 V	—
	- test voltage for 5 sec (V)	1000 V	P
	Test B		
	- Gauge no.1 or no. 4 inserted	(fuse with meltwire)	—
	- rated impulse withstand voltage (V)	8	—
	- test Uimp (kV)	9,8 kV	P
	- rated insulation voltage (V)	500 V	—
	- test voltage for 5 sec (V)	1890 V	P
8.4.4	Contact resistance:)		
	Measurement carried out in direct or alternating current	a.c. / d.c.	—
	rated frequency (Hz) by alternating current	-	—

IEC 60947-7-3			
Clause	Requirement – Test	Result - Remark	Verdict
	Gauge no.2 or no. 5 inserted	Non standard dummy fuse	—
	Screw-type fuse-carrier is tightened with a torque of two-thirds of the value in table 1: (Nm)		N
	Plug-on type or hinged-type fuse-carrier is installed as in normal use		P
	measuring cycle with d.c.		
	a) insertion of gauge in the fuse-holder		P
	b) measurement with current flowing in one direction		P
	c) measurement with current flowing in opposite direction		P
	d) removal of the gauge from the fuse-holder		P
	Measuring cycle with a.c.		
	a) insertion of the gauge in the fuse-holder		N
	b) measurement		N
	c) removal of the gauge from the fuse-holder		N
	Measuring values	See table II	
	The mean value of the contact resistance shall not exceed 10 mΩ		P
	The individual value of the contact resistance shall not exceed 15 mΩ		P
8.4.5	Temperature rise of clamping unit		
	Five terminal blocks are installed side by side with gauge no.2 or no. 5	Non standard dummy fuse	P
	- test current (A)	20 A (80% of 25 A)	—
	- cross-section of the conductor (mm ²)	2,5 mm²	—
	- insulation colour of conductor black	black	P
	- torque (Nm)	-	—
	- temperature rise of the conductor clamping unit does not exceed 45 K	35 K – 45 K	P
8.4.6	Void		

IEC 60947-7-3			
Clause	Requirement – Test	Result - Remark	Verdict
8.4.7	Ageing test (for screwless-type fuse terminal blocks only (see TRF 2166989.52))		
	Five adjacent terminal blocks equipped with gauge no.2 or no. 5		N
	- cross-section of the conductor (mm ²)		—
	Maximum ambient temperature (°C)		—
	Contact resistance		
	Measurement carried out in direct or alternating current	a.c. / d.c.	—
	rated frequency (Hz) by alternating current	-	—
	Screw-type fuse-carrier is tightened with a torque of two-thirds of the value in table 1:..... (Nm)		N
	Plug-on type or hinged-type fuse-carrier is installed as in normal use		N
	measuring cycle with d.c.		
	a) insertion of gauge in the fuse-holder		N
	b) measurement with current flowing in one direction		N
	c) measurement with current flowing in opposite direction		N
	d) removal of the gauge from the fuse-holder		N
	Measuring cycle with a.c.		
	a) insertion of the gauge in the fuse-holder		N
	b) measurement		N
	c) removal of the gauge from the fuse-holder		N
	Heating cabinet is increased, in each cycle to (°C)		—
	Contact resistance after 0 cycles:		

IEC 60947-7-3			
Clause	Requirement – Test	Result - Remark	Verdict
	- requirement: $\leq 15 \text{ m}\Omega$ (m Ω)	1 - 2 - 3 - 4 - 5 -	N
	Voltage drop after the 24th cycle:		
	- requirement: $\leq 15 \text{ m}\Omega$ (m Ω)	1 - 2 - 3 - 4 - 5 -	N
	Voltage drop after the 48th cycle		
	- requirement: $\leq 15 \text{ m}\Omega$ or 1,5 times the value measured after the 24th cycle (m Ω)	1 - 2 - 3 - 4 - 5 -	N
	Voltage drop after the 72th cycle:		
	- requirement: $\leq 4,8 \text{ mV}$ or 1,5 times the value measured after the 24th cycle (m Ω)	1 - 2 - 3 - 4 - 5 -	N
	Voltage drop after the 96th cycle:		
	- requirement: $\leq 15 \text{ m}\Omega$ or 1,5 times the value measured after the 24th cycle (m Ω)	1 - 2 - 3 - 4 - 5 -	N
	Voltage drop after the 120th cycle:		

IEC 60947-7-3			
Clause	Requirement – Test	Result - Remark	Verdict
	- requirement: $\leq 15 \text{ m}\Omega$ or 1,5 times the value measured after the 24th cycle ($\text{m}\Omega$)	1 - 2 - 3 - 4 - 5 -	N
	Voltage drop after the 144th cycle:		
	- requirement: $\leq 15 \text{ m}\Omega$ or 1,5 times the value measured after the 24th cycle ($\text{m}\Omega$)	1 - 2 - 3 - 4 - 5 -	N
	Voltage drop after the 168th cycle:		
	1 - 2 - 3 - 4 - 5 -	1 - 2 - 3 - 4 - 5 -	N
	Voltage drop after the 192th cycle:		
	- requirement: $\leq 15 \text{ m}\Omega$ or 1,5 times the value measured after the 24th cycle ($\text{m}\Omega$)	1 - 2 - 3 - 4 - 5 -	N
	Visual inspection show no changes impairing further use such as cracks, deformations or the like		N
	Pull-out test		
	force (N)		—
	1 min, the conductor shall neither slip out of the terminal nor break near the clamping unit		N
8.5	Verification of thermal characteristics		N

IEC 60947-7-3			
Clause	Requirement – Test	Result - Remark	Verdict
8.5.2	Rated power dissipation		N
8.5.2.2	Test arrangement for the overload and short-circuit protection		
8.5.2.2.1	Separate arrangement	For derating see graphic I	N
	Central terminal with dummy fuse-link of the power dissipation value P_{v1} (W)		—
	- cross-section of the conductor (mm ²)		—
	- torque (Nm)	-	—
	hottest point of the insulating part of the fuse terminal block (TS2) max K (assigned by the manufacturer)		—
	Surface of actuating element (TS1) max 62 K		N
8.5.2.2.2	Compound arrangement	For derating see graphic II	N
	Five terminal blocks shall be installed on a support as in normal use.		N
	- cross-section of the conductor (mm ²) :		—
	- torque (Nm)	-	—
	The fuse terminal blocks shall be equipped with dummy fuse-links of the maximum power dissipation value P_{v2} and central terminal with dummy fuse-link of the power dissipation value P_{v1} (W).....		—
	hottest point of the insulating part of the fuse terminal block (TS2) max K (assigned by the manufacturer)		—
	Surface of actuating element (TS1) max 62 K		N
8.5.2.3	Test arrangement for exclusive short circuit protection		
8.5.2.3.1	Separate arrangement	For derating see graphic III	N

IEC 60947-7-3			
Clause	Requirement – Test	Result - Remark	Verdict
	Central terminal with dummy fuse-link of the power dissipation value P_{v2} (W)	Non standard dummy fuse 80% of 25 A = 20 A	—
	- cross-section of the conductor (mm ²)	2,5 mm²	—
	- torque (Nm)	-	—
	hottest point of the insulating part of the fuse terminal block (TS2) max 102 K (assigned by the manufacturer)	50 K	—
	Surface of actuating element (TS1) max 62 K	36 K	P
8.5.2.3.2	Compound arrangement	For derating see graphic IV	N
	Five terminal blocks shall be installed on a support as in normal use.	Non standard dummy fuse	P
	- cross-section of the conductor (mm ²).....	2,5 mm²	—
	- torque (Nm).....	-	—
	The fuse terminal blocks shall be equipped with dummy fuse-links of the maximum power dissipation value P_{v2} (W)	Non standard dummy fuse 80% of 25 A = 20 A	—
	hottest point of the insulating part of the fuse terminal block (TS2) max 102 K (assigned by the manufacturer)	77 K	—
	Surface of actuating element (TS1) max 62 K	59 K	P
8.5.3	Durability		P
	Fuse terminal blocks shall be resistant to heat and mechanical stresses which are liable to occur in normal use		P

IEC 60947-7-3			
Clause	Requirement – Test	Result - Remark	Verdict
	The fuse terminal block shall be subjected to the test for separate arrangement according to 8.5.2.2.1 or 8.5.2.3.1, as applicable.	Non standard dummy fuse 80% of 25 A = 20 A	P
	The test shall be carried out continuously over a period of 168 h.		P
8.4.3	Dielectric tests		
	- five terminal blocks connected with unfavourable cross-section (mm ²) /type/ conductor end length (mm)	10 mm² rigid 13 mm – 15 mm	—
	- type of most unfavourable support	Top hat rail 35 mm	—
	Dielectric test, Uimp indicated:		
	Test A		P
	- Gauge no.3 or no. 6 inserted	(fuse without meltwire)	—
	- rated impulse withstand voltage (V)	4 kV	—
	- test Uimp (kV)	4,8 kV	P
	- rated insulation voltage (V)	32 V	—
	- test voltage for 5 sec (V)	1000 V	P
	Test B		
	- Gauge no.1 or no. 4 inserted	(fuse with meltwire)	—
	- rated impulse withstand voltage (V)	8 kV	—
	- test Uimp (kV)	9,8 kV	P
	- rated insulation voltage (V)	500 V	—
	- test voltage for 5 sec (V)	1890 V	P
8.4.4	Contact resistance:		
	Measurement carried out in direct or alternating current	a.c. / d.c.	—
	rated frequency (Hz) by alternating current	-	—
	Gauge no.2 or no. 5 inserted		—
	Screw-type fuse-carrier is tightened with a torque of two-thirds of the value in table 1:..... (Nm)		N

IEC 60947-7-3			
Clause	Requirement – Test	Result - Remark	Verdict
	Plug-on type or hinged-type fuse-carrier is installed as in normal use		P
	measuring cycle with d.c.		
	a) insertion of gauge in the fuse-holder		P
	b) measurement with current flowing in one direction		P
	c) measurement with current flowing in opposite direction		P
	d) removal of the gauge from the fuse-holder		P
	Measuring cycle with a.c.		
	a) insertion of the gauge in the fuse-holder		N
	b) measurement		N
	c) removal of the gauge from the fuse-holder		N
	Measuring values	See table III	P
	The mean value of the contact resistance shall not exceed 10 mΩ		P
	The individual value of the contact resistance shall not exceed 15 mΩ		P
8.3.4	Compatibility between fuse terminal blocks and the fuse-link		
	The maximum gauge No. 1 or gauge No. 4 in accordance with table A.1 is inserted and withdrawn 10 times from the fuse-carrier	Non standard dummy fuse	P
	Following each insertion of the gauge, the fuse-carrier is fitted to the terminal block base as in normal position		P
	For fuse terminal blocks with screw-type fuse carrier, the fuse carrier is fitted with a torque of two-thirds of the value specified in table 1 (Nm)		P

IEC 60947-7-3			
Clause	Requirement – Test	Result - Remark	Verdict
	- No visible damage - No looseing of parts - In the most unfavourable position, the - minimum gauge No. 2 or gauge No. 5 is not fall from the fuse-carrier in the most unfavourable position.or fuse terminal blocks with screw-type fuse carrier, the fuse carrier is fitted with a torque of two-thirds of the value specified in table 1 (Nm)	Non standard dummy fuse	P
8.4.4	Contact resistance		
	Measurement carried out in direct or alternating current	a.c. / d.c. 0,1 A	–
	rated frequency (Hz) by alternating current	-	–
	Gauge no.2 or no. 5 inserted	Non standard dummy fuse	–
	Screw-type fuse-carrier is tightened with a torque of two-thirds of the value in table 1:..... (Nm)		N
	Plug-on type or hinged-type fuse-carrier is installed as in normal use		P
	measuring cycle with d.c.		
	a) insertion of gauge in the fuse-holder		P
	b) measurement with current flowing in one direction		P
	c) measurement with current flowing in opposite direction		P
	d) removal of the gauge from the fuse-holder		P
	Measuring cycle with a.c.		
	a) insertion of the gauge in the fuse-holder		N
	b) measurement		N
	c) removal of the gauge from the fuse-holder		N
	Measuring values	See table IV	P
	The mean value of the contact resistance shall not exceed 10 mΩ		P

IEC 60947-7-3			
Clause	Requirement – Test	Result - Remark	Verdict
	The individual value of the contact resistance shall not exceed 15 mΩ		P
8.5.4	Needle flame test		P
	Before the test, the terminal blocks are stored for 24 h in an atmosphere having a temperature between 15°C and 35°C and a relative humidity between 45% and 75%		P
	The flame is applied for 10s. for insulation walls <1 mm and/or an area <100 mm², the flame is applied for 5 s.		P
	The terminal blocks are considered to have passed the test if the duration of burning is < 30s in case of ignition. Moreover, the tissue paper on the pinewood board shall not ignite if burning or glowing particles fall from the terminal block.		P
8.6	Verification of EMC characteristics		N
	Subclause 8.4 of EN 60947-1 applies with the following addition		N
8.6.1	Immunity		N
	Terminal blocks within the scope of this standard are not sensitive of electromagnetic disturbances and therefore no immunity tests are necessary.		N
8.6.2	Emission		N
	Terminal blocks within the scope of this standard do not generate electromagnetic disturbances and therefore no emission tests are necessary.		N

Remarks

Table I: contact resistance after compatibility between fuse terminal blocks and fuse-links, clause 8.3.4

cycle	sample 1		sample 2		sample 3		sample 4		sample 5	
	one direction for d.c. or a.c. (mΩ)	other direction for d.c. only (mΩ)	one direction for d.c. or a.c. (mΩ)	other direction for d.c. only (mΩ)	one direction for d.c. or a.c. (mΩ)	other direction for d.c. only (mΩ)	one direction for d.c. or a.c. (mΩ)	other direction for d.c. only (mΩ)	one direction for d.c. or a.c. (mΩ)	other direction for d.c. only (mVΩ)
1	1,61	1,69	2,10	2,07	1,84	1,79	1,78	1,74	1,94	1,95
2	1,59	1,68	2,16	2,17	1,86	1,80	1,78	1,73	1,96	1,97
3	1,67	1,84	2,14	2,15	1,82	1,78	1,76	1,70	1,91	1,92
4	1,68	1,87	2,18	2,21	1,79	1,75	1,75	1,71	1,89	1,91
5	1,71	1,86	2,21	2,19	1,78	1,76	1,74	1,72	1,89	1,90

Table II: contact resistance, clause 8.4.4

cycle	sample 1		sample 2		sample 3		sample 4		sample 5	
	one direction for d.c. or a.c. (mΩ)	other direction for d.c. only (mΩ)	one direction for d.c. or a.c. (mΩ)	other direction for d.c. only (mΩ)	one direction for d.c. or a.c. (mΩ)	other direction for d.c. only (mΩ)	one direction for d.c. or a.c. (mΩ)	other direction for d.c. only (mΩ)	one direction for d.c. or a.c. (mΩ)	other direction for d.c. only (mΩ)
1	1,72	1,74	2,10	2,12	1,64	1,56	1,81	1,78	1,60	1,61
2	1,74	1,76	2,15	2,16	1,68	1,60	1,84	1,80	1,60	1,60
3	1,76	1,78	2,21	2,23	1,62	1,57	1,79	1,77	1,57	1,59
4	1,71	1,74	2,20	2,18	1,60	1,56	1,76	1,74	1,55	1,56
5	1,68	1,70	2,18	2,17	1,58	1,55	1,74	1,72	1,51	1,52

Table III: contact resistance after durability, clause 8.5.3

cycle	sample 1		sample 2		sample 3		sample 4		sample 5	
	one direction for d.c. or a.c. (mΩ)	other direction for d.c. only (mΩ)	one direction for d.c. or a.c. (mΩ)	other direction for d.c. only (mΩ)	one direction for d.c. or a.c. (mΩ)	other direction for d.c. only (mΩ)	one direction for d.c. or a.c. (mΩ)	other direction for d.c. only (mΩ)	one direction for d.c. or a.c. (mΩ)	other direction for d.c. only (mΩ)
1	2,15	2,17	1,54	1,51	1,90	1,91	1,71	1,74	1,82	1,80
2	2,17	2,19	1,56	1,55	1,89	1,90	1,72	1,74	1,84	1,81
3	2,18	2,18	1,52	1,51	1,84	1,86	1,70	1,72	1,85	1,79
4	2,21	2,19	1,51	1,48	1,86	1,85	1,68	1,68	1,81	1,82

Remarks

5	2,16	2,17	1,50	1,52	1,87	1,84	1,71	1,70	1,79	1,80
---	-------------	-------------	-------------	-------------	-------------	-------------	-------------	-------------	-------------	-------------

Table IV: contact resistance after durability, clause 8.5.3

cycle	sample 1		sample 2		sample 3		sample 4		sample 5	
	one direction for d.c. or a.c. (mΩ)	other direction for d.c. only (mΩ)	one direction for d.c. or a.c. (mΩ)	other direction for d.c. only (mΩ)	one direction for d.c. or a.c. (mΩ)	other direction for d.c. only (mΩ)	one direction for d.c. or a.c. (mΩ)	other direction for d.c. only (mΩ)	one direction for d.c. or a.c. (mΩ)	other direction for d.c. only (mΩ)
1	2,17	2,15	1,61	1,57	1,96	1,94	1,81	1,82	1,84	1,82
2	2,21	2,19	1,62	1,59	1,94	1,92	1,86	1,87	1,79	1,80
3	2,23	2,20	1,64	1,61	1,92	1,89	1,84	1,85	1,82	1,81
4	2,19	2,17	1,66	1,61	1,97	1,92	1,80	1,83	1,84	1,82
5	2,17	2,15	1,65	1,60	2,01	1,95	1,79	1,80	1,83	1,80

Graphic I overload and short-circuit protection

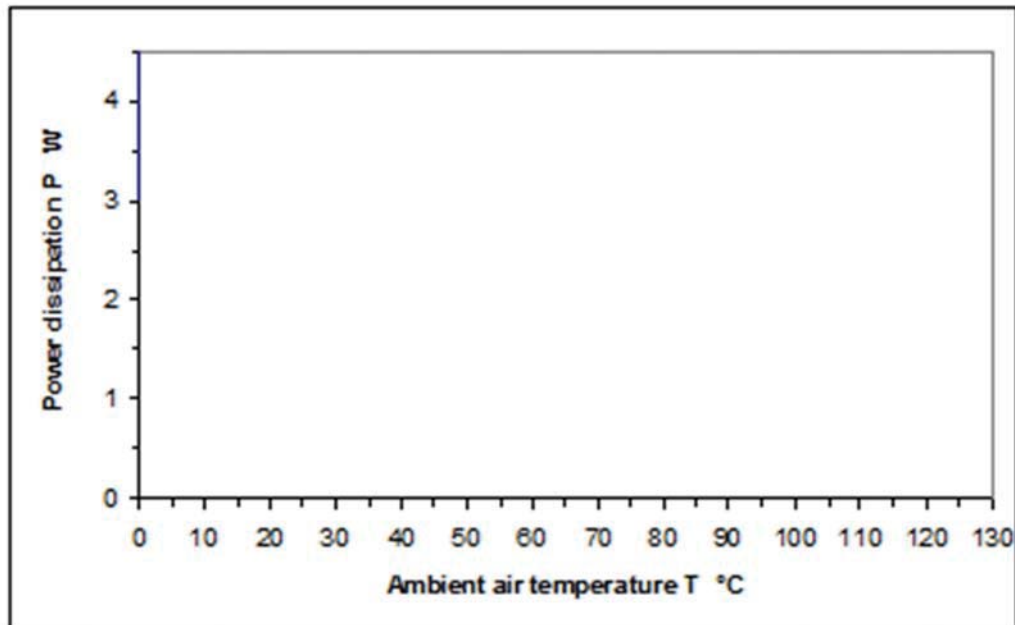

Remarks

Graphic II overload and short-circuit protection

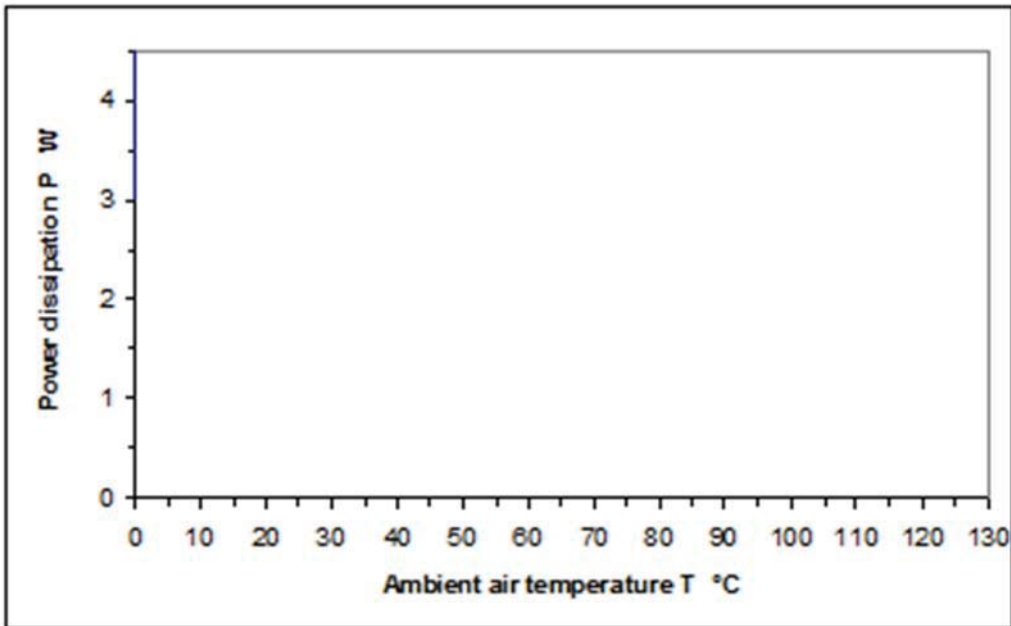

Graphic III for exclusive short-circuit protection

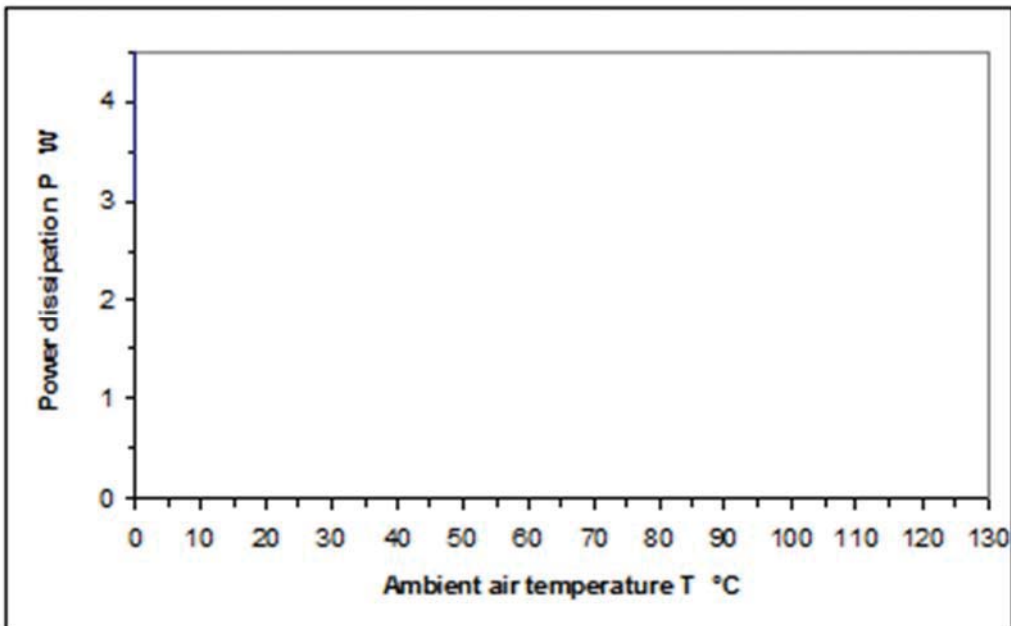

Remarks

Graphic IV for exclusive short-circuit protection

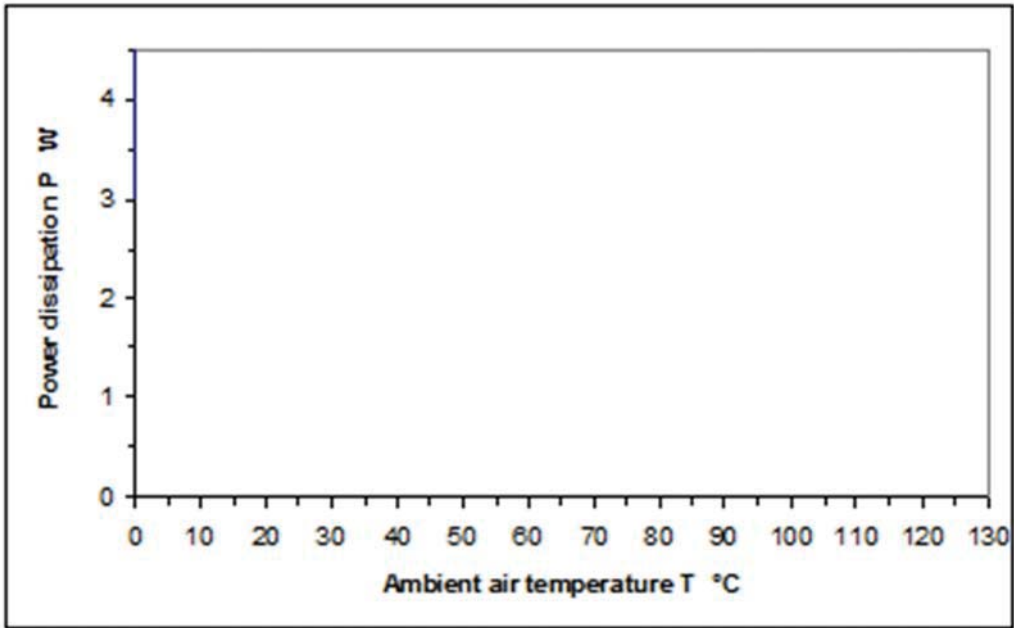

Remarks

Product	: terminal blocks
Trade name(s)	: WAGO
Type(s)/model(s)	: TOPJOB S 2006
Material	: thermoplastic material
Rated connecting capacity	: 6 mm ² / 10 mm ² rigid and flexible
Connectable conductors	: 0,5 mm ² - 10 mm ² rigid and flexible
Method of mounting	: for mounting on top hat rail 35 mm
Current	: 25 A (6 mm ²)
Rated voltage	: 500 V
Rated impulse withstand voltage	: 8 kV (adjacent terminal block) 4 kV (internal)
Type	: 2006 with suffixes -1681, -1682, -1683, -1684
Description	: 2 conductor fuse terminal block for mini-automotive blade style fuses, with screwless type terminals, 1-pole
Type	: 2006-1681 with suffixes /1000-429 with blown fuse indication 12 V, anode of LED on the right side /1000-449 with blown fuse indication 12 V, anode of LED on the left side /1000-413 with blown fuse indication 24 V, anode of LED on the right side /1000-434 with blown fuse indication 24 V, anode of LED on the left side /1000-414 with blown fuse indication 48 V, anode of LED on the right side /1000-435 with blown fuse indication 48 V, anode of LED on the left side

Remarks

