

Basic Installation Instructions  
Air Handling Unit Kit  
Model No. **PAW-280PAH3M**



(Use QR Code for full instruction manual)

Read through the Installation Instructions before you proceed with the installation.

Please carefully read the “Safety Precautions”. This booklet mainly mentions the safety-related regulatory matters. Regarding the contents of the installation, please scan the matrix two-dimensional (2D) barcode and refer to the detailed manuals.

Panasonic will accept no responsibility for any accident or damage that occurs because of such improper installation in any way not described in the detailed manuals. Also, malfunction caused by incorrect installation is not covered by the product warranty.

## Contents

1.	Safety Precautions.....	2
2.	Installation location.....	4
2.	Dimensions.....	5
3.	Technical specification – AHU Kit.....	5
4.	Connection cable between outdoor and AHU-Kit.....	6
a.	PZ3 / PZH3 connection wiring.....	6
b.	PZH2 connection wiring.....	7
5.	Terminal connection overview.....	8
6.	Installation of thermistor on liquid pipe.....	9
7.	Installation of thermistor on heat exchanger pipe middle.....	10
8.	Installation of thermistor for suction and discharge air stream.....	10
9.	Adjustments before system can operate.....	11
a.	If outdoor unit type PZ3 / PZH3 / PZH2 is connected.....	11
b.	The basic steps are as follows:.....	11
c.	Adjust the settings.....	11
10.	AHU-Kit Wiring lay out.....	14
11.	Parts location overview.....	14

### Please Read Before Starting

These basic instructions are typical for most installation sites. Please refer to the full Installation Instructions for extended information! If you require help for a special problem, contact our sales/service outlet or your certified dealer for additional instructions.

- This product is an Air handling Unit Kit

**IMPORTANT!**

Please Read Before Starting

This Air Handling Unit Kit must be installed by the sales dealer or suitably qualified installer.

This information is provided for use by authorized persons only.

## 1. Safety Precautions

We assume no responsibility for accidents or damages resulting from methods other than those described in the Installation Instructions or methods using unspecified parts.

Malfunctions that occur due to unauthorized installation methods are not covered by the product warranty.

- This Air Handling Unit Kit must be installed in accordance with National Wiring Regulations.
- Please also read installation instructions of connected devices.
- When relocating or repairing this Air Handling Unit Kit, provide the Installation Instructions to the servicing personnel.

	<p><b>WARNING</b></p> <p>This symbol refers to a hazard or unsafe practice which can result in severe personal injury or death.</p>
---	---

	<p><b>CAUTION</b></p> <p>This symbol refers to a hazard or unsafe practice which can result in personal injury or product or property damage.</p>
---	---

	<p>Prohibited matters</p>
---	---------------------------

### Precautions for Installation setup

 <p><b>WARNING</b></p>
<ul style="list-style-type: none"> <li>• Turn off the circuit breaker of the units before installation.</li> <li>• Select an installation location which is rigid and strong enough to support or hold this Air Handling Unit Kit and select a location for easy maintenance.</li> <li>• Use only the parts specified by Panasonic as supplied accessories.</li> <li>• Ensure cables are installed properly so that external forces cannot affect them.</li> <li>• Disassembly and modification of this Air Handling Unit Kit is not permitted under any circumstances.</li> </ul>



## WARNING

- This Air Handling Unit Kit must be installed by the sales dealer or installer.
- When installing the Air Handling Unit Kit, use appropriate protective equipment and tools for safety.
- This Air Handling Unit Kit should be securely installed in accordance with the Installation Instructions.
- Electric work must be performed by authorized personnel in accordance with the local regulations and in accordance with the Installation Instructions.
- To avoid malfunctions caused by radio wave interference, keep the Air Handling Unit Kit away from devices such as other wireless devices, microwaves and devices that use 2.4 GHz signal. Depending on the area, the module may not be available.
- Attach the electrical cover to the indoor unit securely.
- Make sure to connect the Air Handling Unit Kit to the PCB and terminal board of the outdoor unit properly.
- Do not set up in hospitals or places where electronic medical devices are located.
- If you have a cardiac pacemaker or implantable cardioverter defibrillator, please keep at least 15 cm away from the Air Handling Unit Kit.
- Do not use the remote controller near to automatic control equipment (automatic door, fire alarms, etc.).
- In case of an abnormal condition (such as a burning smell), stop the indoor unit and turn the breaker OFF.
- Do not operate with wet hands.
- Do not splash water into open Air Handling Unit Kit or use it in the bathroom.



## Caution

- Ground yourself to discharge static electricity before performing any wiring.
- Do not install the Air Handling Unit in places with direct sunlight or where the ambient temperature is more than 45°C. Follow specifications.
- The connecting cable must not touch piping directly.
- Do not set up where children can reach the Air Handling Unit Kit.
- Do not stand on an unstable surface when operating or checking the Air Handling Unit Kit
- Do not use in special environments.  
Use in places with large amounts oil (including machine oil), steam, flammable or corrosive gas, voltage fluctuation, surrounding the metal body, may lead to severe decrease in functionality and damage to parts.
- Do not use the Air Handling Unit Kit near other wireless devices, microwaves, cordless phones, or facsimiles.

## Note

- **Install this Air Handling Unit Kit vertically.**
- **When attaching this Air Handling Unit Kit, be sure to fix it in a proper way and confirm that Air Handling Unit is fixed.**
- **The warranty does not cover the product if it falls from an elevated location.**
- **For the set up and commissioning please check the remote controller manual**

## 2. Installation location

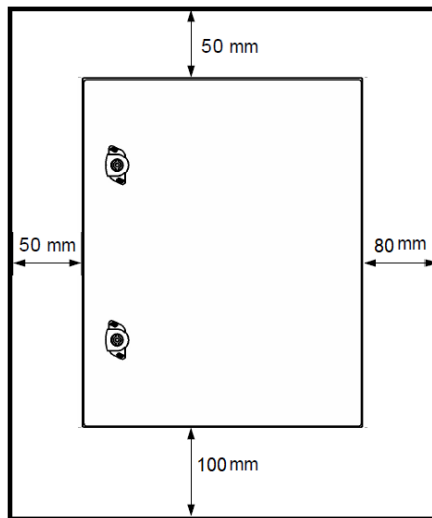

- Install at the height of 100 mm or more (Due to space of wiring)
- Keep a space around the Air Handling Unit Kit as detailed on the figure shown above.
- Avoid the following locations for installation.
  - In direct sunlight
  - Location where vibrations can occur
  - Location where too much dust or water occurs (The AHU-Kit Protection Code is IP65)
  - Location where condensation occurs
  - Location near heat sources
- Keep a distance of 1 m or more from TVs, radios, and PCs. (Image blur or related noise may occur)
- In the case of high humidity there is the possibility of condensation water inside the Air Handling Unit Kit occurring, in this case retrofit the AHU-Kit with pressure equalization (This measure is to be created on site if required)
- Do not use in special environments.  
Use in places with much oil (including machine oil), steam, flammable or corrosive gas, voltage fluctuation, surrounding the metal body, may lead to severe decrease in functionality and damage to parts.

## 2. Dimensions

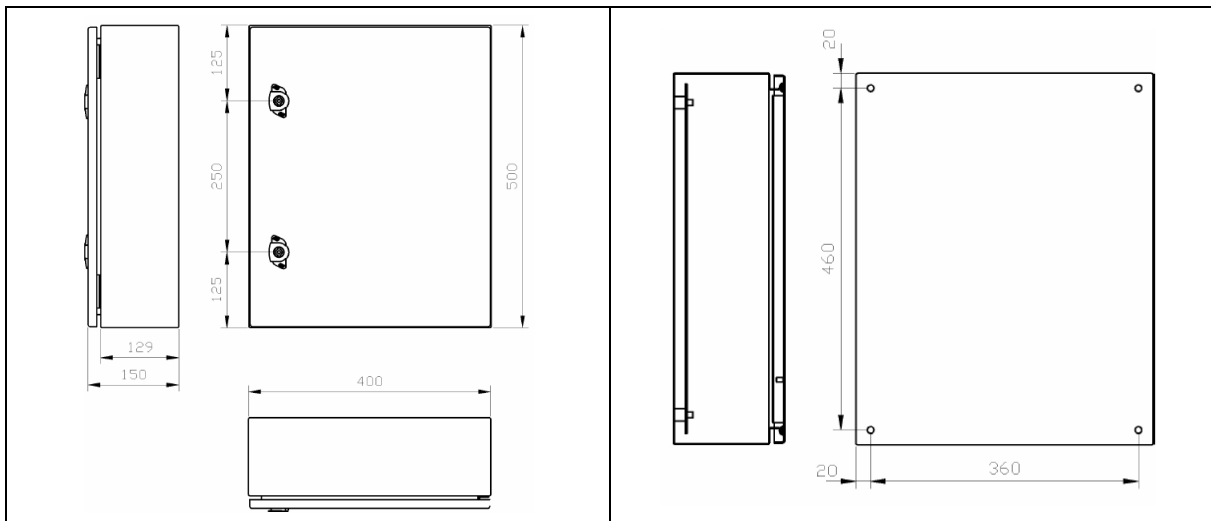

## 3. Technical specification – AHU Kit

PAW-280PAH3M technical data	Unit	Value
Power source	V / ph / Hz	220 ... 240 / 1 / 50
Rated current consumption	A	0.1
Rated power consumption (max.)	W	18.0
Dimensions (enclosure)	mm	400 x 500 x 150 (W x H x D)
Net weight	kg	11.5
Ambient temperature (max.)	°C	45
Protection class	-	IP65

## 4. Connection cable between outdoor unit and AHU-Kit

### a. PZ3 / PZH3 connection wiring

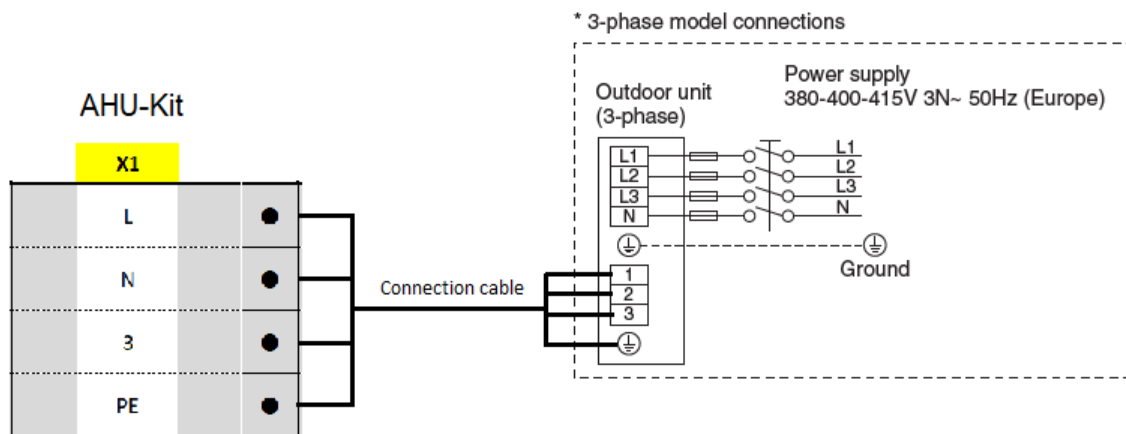
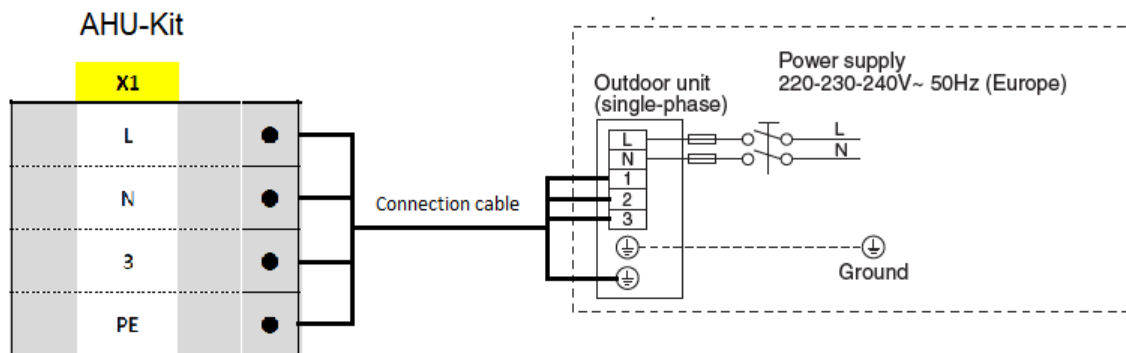

For the power supply cable of the outdoor units, refer to the relevant installation instructions of the outdoor unit in question.

Connection cable between AHU kit and outdoor unit:

Outdoor Unit	Connection cable
U-36 ~ 71PZ3E5	0,75 mm <sup>2</sup> (min.)
U-100 ~ 140PZ3E5, U-100 ~ 140PZ3E8	0,75 mm <sup>2</sup> (min.)
U-36~60PZH3E5	0,75 mm <sup>2</sup> (min.)
U-71 ~ 140PZH3E5, U-71 ~ 140PZH3E8	0,75 mm <sup>2</sup> (min.)

b. PZH2 connection wiring

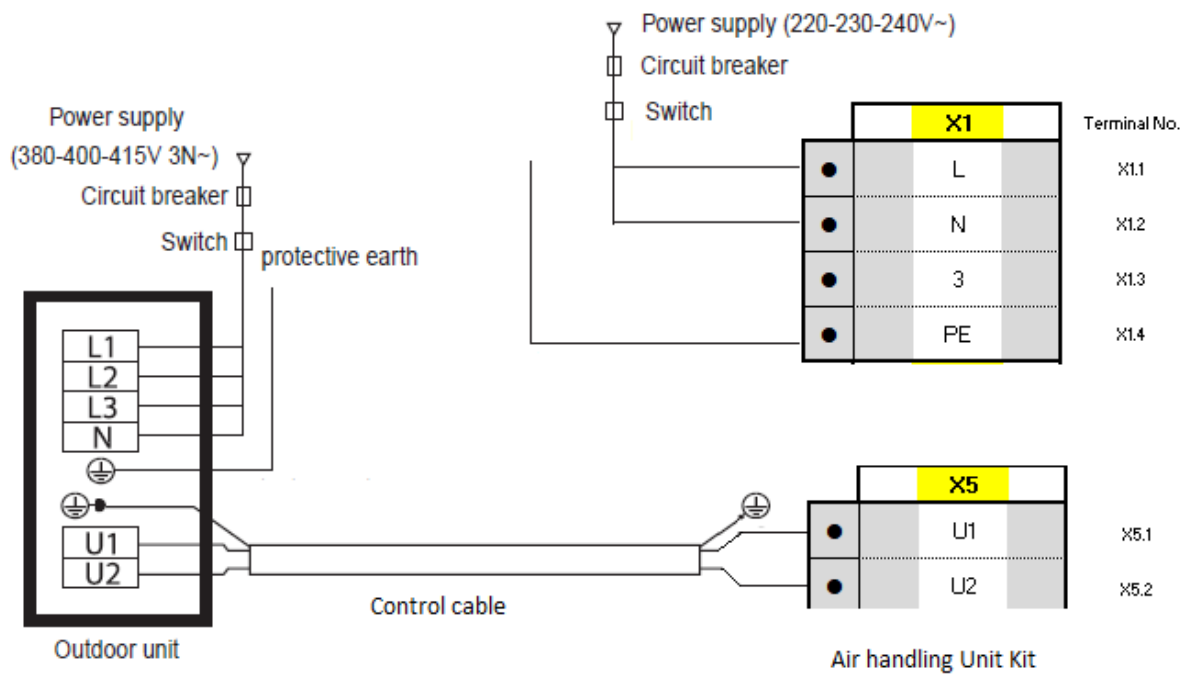

Outdoor Unit	For the circuit breaker, power supply cable, others refer to the installation instructions of the outdoor units	
AHU-Kit	Circuit breaker	Control and power supply cable
	6 A*	0,75 mm <sup>2</sup> ** (min.)
*Circuit breaker must be incorporated in the fixed wiring in accordance with the wiring regulations. **Use a shielded cable for the control cable. Overall extension less than 1000 m.		

## 5. Terminal connection overview

		Terminal No.	Allocation	Function	Description
			<b>X1</b>		
●	L	X1.1	Live	Live Terminal	External Potential: 230 V AC, max. 1 A
●	N	X1.2	Neutral	Neutral Terminal	
●	3	X1.3	Comm	Communication terminal	Internal potential 0 - 75 V DC
●	PE	X1.4	Protective earth	Protective Earth Conductor	
			<b>X2</b>		
●	F1	X2.1	Potential for F2	Fan Operation Signal	External Potential: max. 250 VAC 8 A
●	F2	X2.2	Fan contact		
			<b>X3</b>		
●	FS1	X3.1	Potential for FS2	Float switch (ex factory bridged)	Internal Potential: 12 V DC
●	FS2	X3.2	Float switch		
●	FD1	X3.3	Potential for FD2	Control of an additional external fan or additional external air handling unit	Internal potential: 12 V DC
●	FD2	X3.4	Fan Signal		
●	EX1	X3.5	Potential for EXCT	EXCT-Contact (external thermostat off switch)	Internal Potential: 5 V DC
●	EX2	X3.6	EXCT-Contact		
			<b>X4</b>		
●	TA1	X4.1	No polarity	Suction Temperature Sensor TA (included) (Room Temperature Sensor)	
●	TA2	X4.2	No polarity		
●	E1.1	X4.3	No polarity	Sensor E1 / TH2	
●	E1.2	X4.4	No polarity		
●	E2.1	X4.5	No polarity	Sensor E2 / TH3	
●	E2.2	X4.6	No polarity		
●	OP1	X4.7	12 V DC	12 V DC	12 V DC relay required for each signal output, field supplied
●	OP2	X4.8	Potential of Defrost	Defrost signal output	
●	OP3	X4.9	Potential for Thermostat	Thermostat signal output	
●	OP4	X4.10	Potential for Cool start	Cool operation signal output	
●	OP5	X4.11	Potential for Heat start	Heat operation signal output	
●	OP6	X4.12	Potential for Fan start	Fan (free cooling) operation signal output	
●	OT1	X4.13	Potential for OT2 - OT6	COM	
●	OT2	X4.14	Heat input	Heat mode input	5 V DC 0.5mA Current input
●	OT3	X4.15	Cool input	Cool mode input	
●	OT4	X4.16	Demand Input 1	LV1 demand control input	Demand control, QUIET and EXCT inputs must be set using indoor unit detailed settings, parameter code 0002EE, please see relevant technical
●	OT5	X4.17	Demand Input 2	LV2 demand control / QUIET input	



●	OT6	x4.18	Demand Input 3	LV3 demand control / EXCT (forcibly thermostat off) input	data service manual for details. 5 V DC 0.5mA Current input
	X5				
●	U1	x5.1	No polarity	Communication bus wiring P-link	Required for centralized controller
●	U2	x5.2	No polarity		
●	R1	x5.3	No polarity	Terminal for Group Wiring (RC connection)	Internal Potential: 16 V DC
●	R2	x5.4	No polarity		
●	R1	x5.5	No polarity	Terminal for Group Wiring (RC connection)	Internal Potential: 16 V DC
●	R2	x5.6	No polarity		
	X6				
●	M2.1	x6.1	4 - 20 mA	Analogue output terminals	Analog output (Room temperature monitor), Indoor temperature monitor output. Output current : 4 to 20 mA. Temperature indication range : 5 to 36 °C, 0.5 °C step
●	M2.2	x6.2	Potential of M2.1		
●	M2.3	x6.3	0 to 10 V DC	Analogue input terminals for temperature and demand control	Analogue input (+10 V DC) for demand control / temperature control Analog input Negative potential (-10 V DC) for demand control / temperature setting
●	M2.4	x6.4	Potential of M2.3		
●	M2.5	x6.5	No polarity	Activation of demand control	Insert bridge to activate temperature control (system is set for demand control as standard)
●	M2.6	x6.6	No polarity		
●	COM	x6.7	Potential for DI1 to DI3	Digital Inputs (For information on functionality refer to section "Terminal layout – CZ-CAPBC2 / ACC-SP1A" in this document)	2 types of usage: a) Potential-free: Keep S3 of CZ-CAPBC 2/ ACC-SP1A on "NON VOLTAGE". b) 12 to 24 V DC, 10 mA external: Change S3 of CZ-CAPBC2 / ACC-SP1A to "VOLTAGE".
●	DI1	x6.8	Digital Input 3		
●	DI2	x6.9	Digital Input 2		
●	DI3	x6.10	Digital Input 1		
●	COM	x6.11	Potential for DO2	Alarm Signal	External Potential: max. 230 V AC / 3 A
●	DO2	x6.12	Alarm Signal		
●	COM	x6.13	Potential for DO1	Operation Signal	External Potential: max. 230 V AC / 3 A
●	DO1	x6.14	Operation Signal		

## 6. Installation of thermistor on liquid pipe

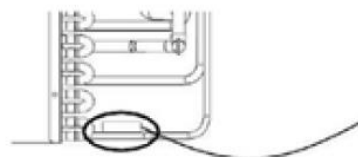

Mount the "E1" thermistor to the liquid pipe of the AHU heat exchanger according to the following instructions

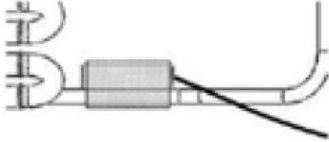
Attach the liquid pipe thermistor to the liquid pipe located in the lowest position after the distributor in the heat exchanger.

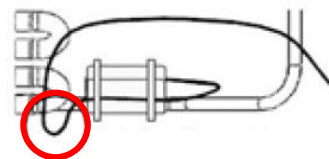

Cover the thermistor and pipe with aluminum tape.	
Cover the aluminum tape with thermal insulation.	
Fix thermal insulation and wiring with two bands. Then, run the wire downwards in a loop, to avoid putting tension and prevent ingress of moisture due to condensate.	

## 7. Installation of thermistor on heat exchanger pipe middle

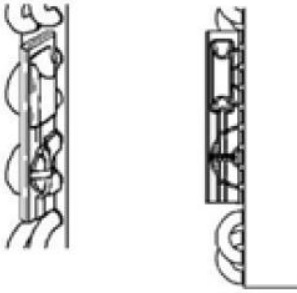
<b>Mount the “E2” thermistor to the middle of the heat exchanger pipe, according to the following instructions.</b>			
1) Attach the thermistor to the middle of the heat exchanger in the middle of each pass-line (pipe) in the heat exchanger.		2) Cover the thermistor and pipe with aluminum tape (field-supplied).	
3) Fix thermistor with two bands. Then, run the wire downwards in a loop, to avoid putting tension to it and avoid ingress of moisture due to condensate		4) Cover the aluminum tape with thermal insulation. And also cover the sensor (copper portion) with thermal insulation completely.	

## 8. Installation of thermistor for suction or discharge air stream

Mount the suction or discharge air thermistor according to the following instructions.

1. Attach the suction air thermistor (TA) to the position where air suction temperature can be measured, or where the air discharge temperature can be measured in case you wish to directly control the supply air.

## 9. Adjustments before system can operate

### a. If outdoor unit type PZ3 / PZH3 / PZH2 is connected



It is necessary to set the PACi NX Air Handling Unit Kit manually to a dedicated capacity. This cannot be done automatically.

### b. The basic steps are as follows:

- Install the system as normal, and power up.
- The system will try and auto-address; "Assigning" will be shown on the controller. Whilst this is displayed, **and within 30 seconds of it appearing**
- Enter detailed settings mode on the controller and edit the settings that follow.
- Once detailed settings are completed – the system will auto-address itself. This time, it will complete, and you will be left with a running system.

### c. Adjust the settings

After finishing piping, pressure test, evacuation, charging and wiring connection as described in the installation instruction of the units, once the system has been powered up, and within about 30 seconds to max. 1 minute, while "Assigning" is blinking -

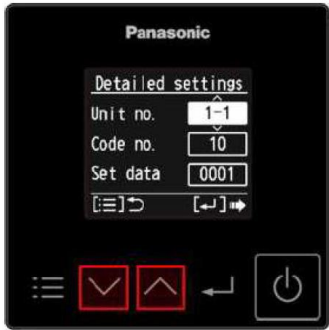

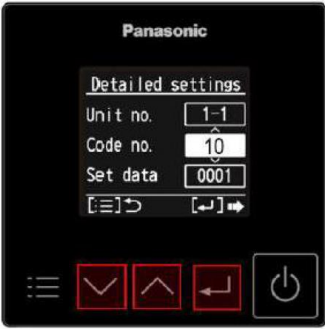
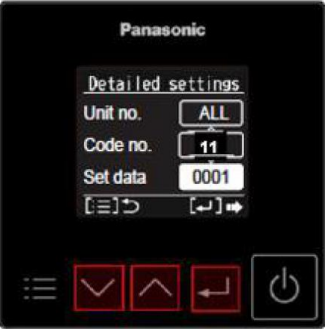

No.	Instruction	Image
1	<p>Press and hold the buttons shown on the controller. (marked red)</p> <p><b>Note:</b> If you fail to press the buttons quickly enough, E16 error code will be displayed. In this event, switch power off and repeat this step within 30 seconds of the display powering on.</p>	
2	<p>Scroll to "Detailed Settings" and press enter:</p> <p>Scroll down</p> <p>As soon as "Detailed settings" is reached and highlighted, press enter</p>	
No.	Instruction	Image
3	<p>Select the "Unit no." and press enter. This will usually be "1-1", if already addressed. In the case it is not yet been addressed "ALL" will be displayed.</p>	

4	<p>Make sure “Code no.” is highlighted, using up/down arrows if needed. If not highlighted, press enter key shortly, and you will be able to alter the code number using up/down arrows.</p>	
5	<p>Select code number “11” and press enter key shortly, if not already highlighted, with up/down arrows make sure “Set data” is highlighted now. You will be able to alter the parameter value, please change it from default data “0000” according to below table. Once you have set the corresponding data value by using the up/down arrows, confirm with the enter button.</p> <p>e.g., Outdoor unit: <b>U-71PZ3E5</b> Parameter value set to: “0012”</p>	

Parameter value setting table

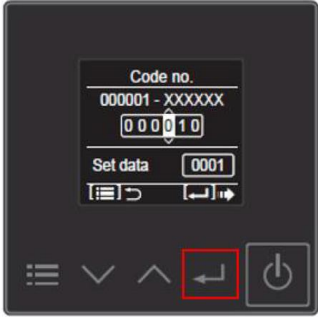
PACi NX outdoor unit model		Setting for AHU kit code "11"
Standard	Elite	
U-36PZ3E5	U-36PZH3E5	5
U-50PZ3E5	U-50PZH3E5	9
U-60PZ3E5	U-60PZH3E5	11
U-71PZ3E5	U-71PZH3E5	12
	U-71PZH3E8	
U-100PZ3E5	U-100PZH3E5	15
U-100PZ3E8	U-100PZH3E8	
U-125PZ3E5	U-125PZH3E5	17
U-125PZ3E8	U-125PZH3E8	
U-140PZ3E5	U-140PZH3E5	18
U-140PZ3E8	U-140PZH3E8	
Big PACi outdoor unit model		
	U-200PZH2E8	21
	U-250PZH2E8	23

If you wish to ignore AHU capacity by the OU control, please follow steps 6 – 8, if not, you can directly go to step 9.

No.	Instruction	Image
6	<p>You will be back in the same screen as indicated in Number 3.</p> <p>Press enter again and <b>“Code no.”</b> will be highlighted.</p> <p>In this state keep pressing enter button for 2 seconds or more and you will be directly in the 6 digit <b>“Code no.”</b> where you can select the desired code easily by altering each digit one by one, which is much faster than scrolling up/down the whole code list:</p>	
7	<p>After altering one digit with up/down arrows, press enter and you can set the next digit. In this way select code <b>“000303”</b>:</p>	
8	<p>After having set <b>“000303”</b> under <b>“Code no.”</b> press enter again and <b>“Set data”</b> will become highlighted. With the up/down arrows alter to <b>“0002”</b> and confirm with enter:</p>	
9	<p>When you have completed the detailed code settings, press <b>“List button”</b> and you will be prompted to <b>“Exit detailed settings and restart”</b>. Press enter to confirm <b>“YES”</b>, and the controller will restart.</p>	

The system will address itself automatically during restart. Once it is finished and the display returns to the standard initial screen, you may now operate the system as normal.

## 10. AHU-Kit Wiring lay out

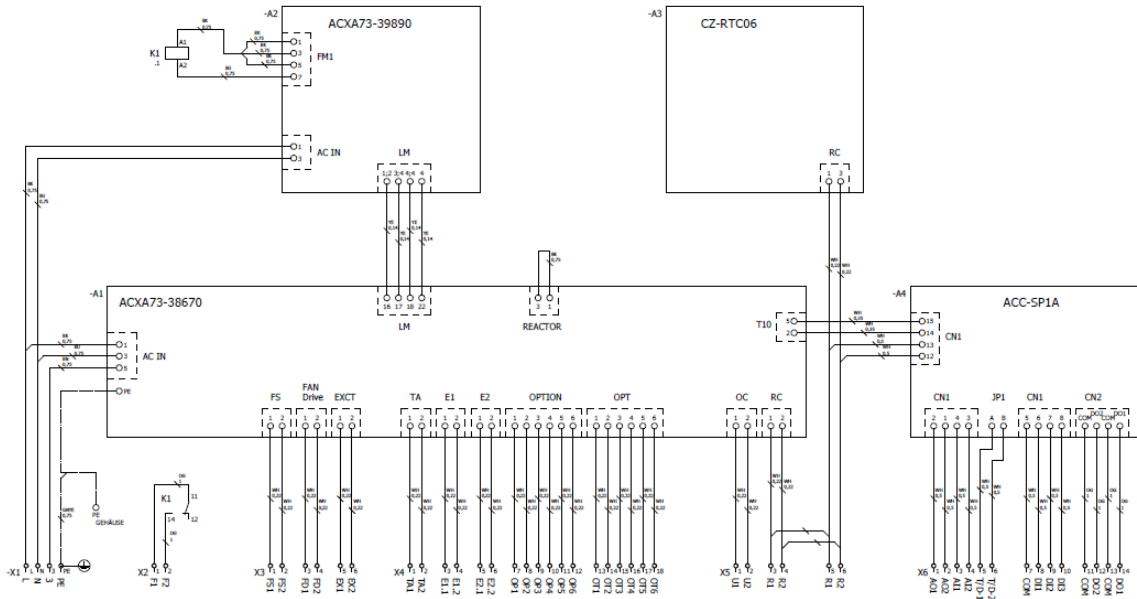

## 11. Parts location overview

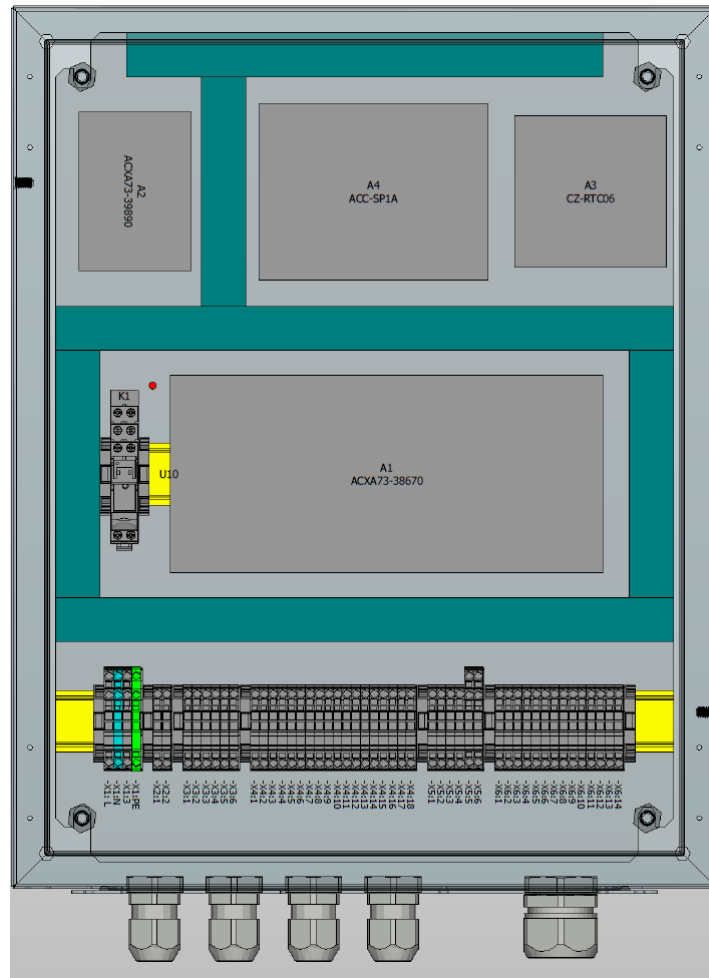



Klein Solutions

GmbH & Co. KG  
Kanadastraße 4  
D-58675 Hemer  
Germany