

## ESMKV 50

Cable gland hexagonal, brass nickel-plated, M50, with short thread

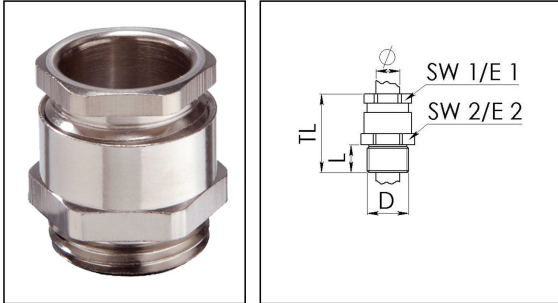

Products may differ in size, colour and appearance to those shown. If you require further information or customisation, please contact us directly.



<b>Material cable gland</b>	Brass nickel-plated
<b>Material sealing gasket</b>	Soft rubber
<b>Temp. range min</b>	-30 °C
<b>Temp. range max</b>	80 °C
<b>Protection class</b>	IP54
<b>Thread type</b>	M
<b>Ø Connection thread D</b>	50
<b>Lead</b>	1,5
<b>Length screw-in thread L</b>	9 mm
<b>Ø cable diameter min</b>	31 mm
<b>Ø cable diameter max</b>	42 mm
<b>Key width SW1</b>	50 mm
<b>Key width SW2</b>	52 mm
<b>Collar diameter E1</b>	54 mm
<b>Collar diameter E2</b>	56 mm
<b>Total length TL</b>	48 mm
<b>Impact category</b>	6
<b>Surface</b>	Nickel-plated
<b>Order no. nickel-plated</b>	10062876
<b>Type</b>	ESМКV 50
<b>Packing unit</b>	5
<b>ETIM-Classification</b>	EC000441

Your Contact:

**WISKA Hoppmann GmbH**

Kisdorfer Weg 28 · 24568 Kaltenkirchen · Germany

☎ +49-4191-508-0 · 📠 +49-4191-508-209

contact@wiska.de · www.wiska.com

**Recommended accessories**

<b>EMMU 50</b>	10063147
<b>ORD-E 50</b>	10064703

25.02.2021

Your Contact:

**WISKA Hoppmann GmbH**

Kisdorfer Weg 28 · 24568 Kaltenkirchen · Germany

☎ +49-4191-508-0 · 📠 +49-4191-508-209

contact@wiska.de · www.wiska.com

