

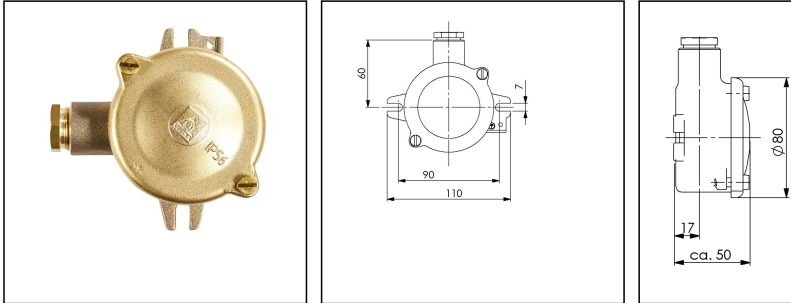

1149-1xZ14

HNA Junction box, brass



Products may differ in size, colour and appearance to those shown. If you require further information or customisation, please contact us directly.



WISKA-Order no.	10010496
Type	1149-1xZ14
Voltage	500 V
Current	16 A
Protection class	IP56
Material	Brass
Material cable gland	Brass
Using for cable gland	
Type of cable	armoured
Ø cable diameter min	12 mm
Ø cable diameter max	14,5 mm
Type of cable gland	M 24 x 1,5
External dimensions LxWxH	110x100x50mm
Mounting	Surface mounting
Temp. range min	-25 °C
Temp. range max	45 °C
Terminals/poles	4-pole, 2,5 mm ²
Operational areas	Outdoor, Indoor work space, Engine room
Norm	DIN 89250
Weight	0,66 kg
Variations	on request

Spare parts

Your Contact:

WISKA Hoppmann GmbH

Kisdorfer Weg 28 · 24568 Kaltenkirchen · Germany

☎ +49-4191-508-0 · 📠 +49-4191-508-209

contact@wiska.de · www.wiska.com

SP-181/4 Terminal block	22000352
SP-HNA Cover sealing	22000838

07.09.2020

Your Contact:

WISKA Hoppmann GmbH

Kisdorfer Weg 28 · 24568 Kaltenkirchen · Germany

☎ +49-4191-508-0 · 📠 +49-4191-508-209

contact@wiska.de · www.wiska.com

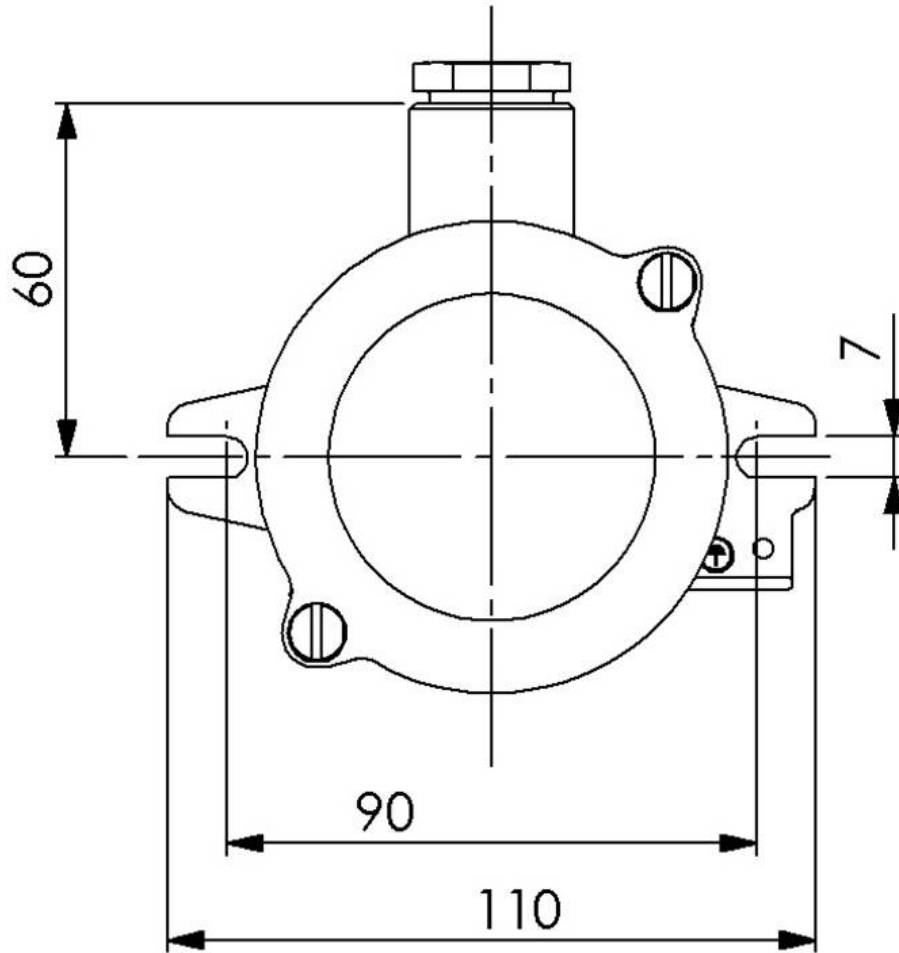

Your Contact:

WISKA Hoppmann GmbH

Kisdorfer Weg 28 · 24568 Kaltenkirchen · Germany

☎ +49-4191-508-0 · 📠 +49-4191-508-209

contact@wiska.de · www.wiska.com

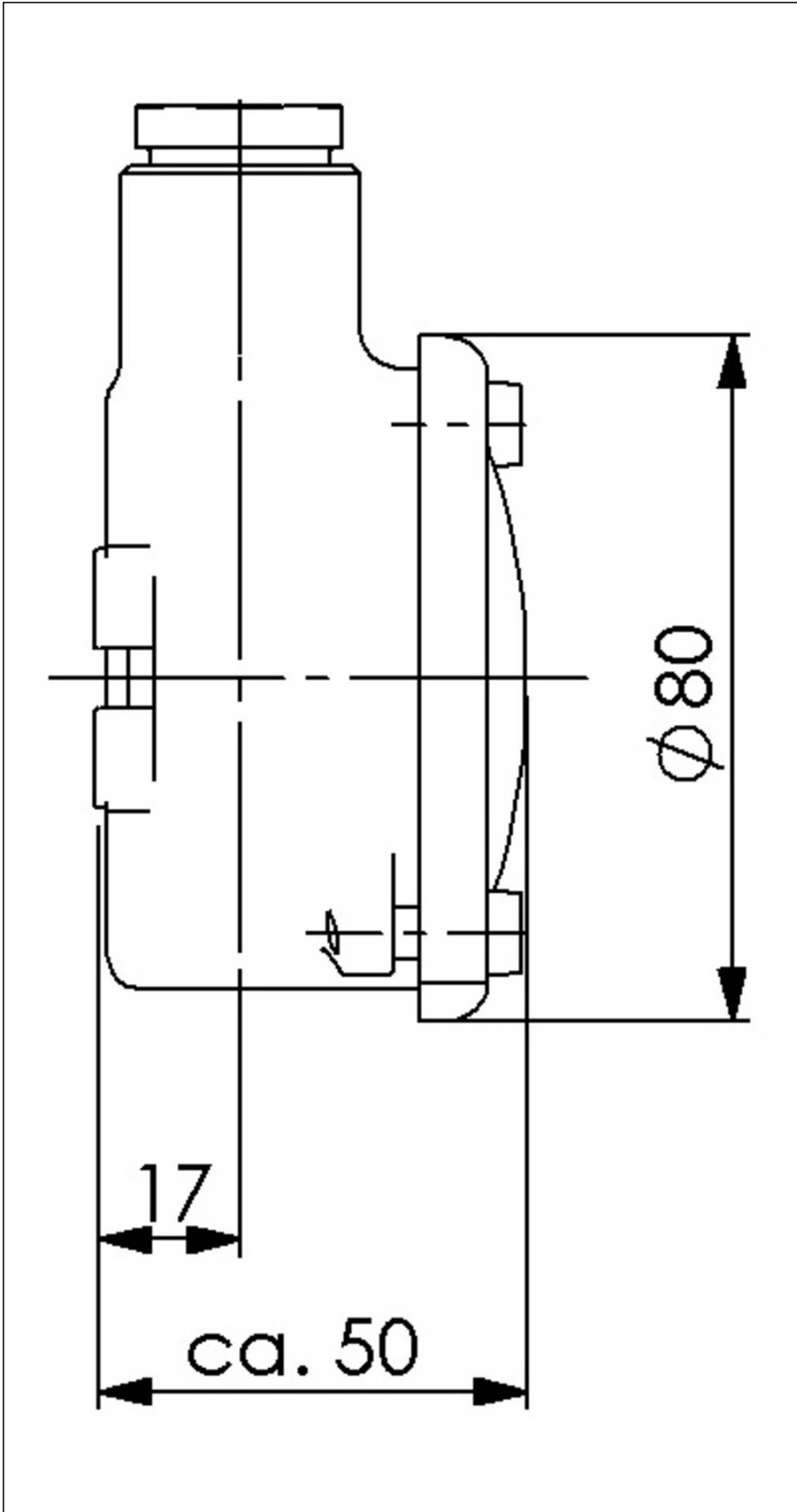

Your Contact:

WISKA Hoppmann GmbH

Kisdorfer Weg 28 · 24568 Kaltenkirchen · Germany

☎ +49-4191-508-0 · 📠 +49-4191-508-209

contact@wiska.de · www.wiska.com