

P I X S Y S
elettronica



- **REGOLATORE**
 - **CONTROLLER**
-

ATR142

Manuale Installatore
User Manual

Summary

1	Introduction.....	4
2	Model Identification.....	4
3	Technical Data	5
3.1	General Features.....	5
3.2	Hardware Features.....	5
3.3	Software Features	6
4	Dimensions and Installation.....	6
5	Electrical wirings.....	7
5.1	Wiring diagram	7
6	Display and Key Functions	10
6.1	Numeric Indicators (Display)	11
6.2	Meaning of Status Lights (Led)	11
6.3	Keys.....	11
7	Controller Functions	12
7.1	Modifying Main Setpoint and Alarm Setpoint Values	12
7.2	Auto-Tune	12
7.3	Manual Tuning.....	12
7.4	Automatic Tuning.....	13
7.5	Soft Start.....	13
7.6	Automatic/Manual Regulation for % Output Control	13
7.7	Pre-Programmed Cycle	14
7.8	Memory Card (optional).....	15
7.9	Loading default values.....	16
8	LATCH ON Functions.....	16
8.1	Digital Input Functions.....	18
8.2	Dual Action Heating-Cooling	19
9	Serial Communication	21
9.1	Slave.....	21
9.2	Master.....	26
10	Configuration	28
10.1	Modify Configuration Parameter.....	28
11	Table of Configuration Parameters	29
12	Alarm Intervention Modes.....	43
13	Table of Anomaly Signals.....	48
14	Summary of Configuration parameters	49

Sommario

15	Introduzione.....	52
16	Identificazione del modello	52
17	Dati tecnici.....	53
17.1	Caratteristiche generali.....	53
17.2	Caratteristiche hardware	53
17.3	Caratteristiche software.....	54
18	Dimensioni e installazione	54
19	Collegamenti elettrici	55
19.1	Schema di collegamento	55
20	Funzione dei visualizzatori e tasti	58
20.1	Indicatori numerici (display).....	59
20.2	Significato delle spie di stato (led)	59
20.3	Tasti.....	59
21	Funzioni del regolatore	60
21.1	Modifica valore setpoint principale e setpoint di allarme.....	60
21.2	Auto-tune	60
21.3	Lancio del Tuning Manuale	60
21.4	Tuning Automatico.....	61
21.5	Soft Start.....	61
21.6	Regolazione automatico / manuale per controllo % uscita	61
21.7	Ciclo pre-programmato.....	62
21.8	Memory Card (opzionale)	63
21.9	Caricamento valori di default.....	64
22	Funzioni LATCH ON.....	64
22.1	Funzioni da Ingresso digitale.....	66
22.2	Funzionamento in doppia azione (caldo-freddo)	67
23	Comunicazione Seriale.....	69
23.1	Slave.....	69
23.2	Master.....	74
24	Configurazione	76
24.1	Modifica parametro di configurazione	76
25	Tabella parametri di configurazione	77
26	Modi d'intervento allarme.....	91
27	Tabella segnalazioni anomalie.....	96
28	Promemoria configurazione.....	97

1 Introduction

Thank you for choosing a Pixsys controller.

With the ATR142 model Pixsys makes available in a single device all the resources relevant to sensor input and actuators command, in addition to the extended power range 24...230 Vac/Vdc. With 17 sensors to select and outputs configurable as relay or SSR command, the user or retailer can reduce warehouse stock by rationalising investment and device availability. The series is completed with models equipped with serial communication RS485 Modbus. The configuration is further simplified by the Memory cards which are equipped with internal battery and therefore do not require cabling to power the controller.

2 Model Identification

The range of ATR142 controllers comes in two versions. Refer to the table below to easily select your preferred model.

Models available, with power 24...230 Vac/Vdc
+/-15% 50/60Hz – 3,5VA

ATR142-ABC	2 relays (8A+5A) + 1 SSR
ATR142-ABC-T	1 relays 8A + 1 Ssr + RS485

3 Technical Data

3.1 General Features

<i>Displays</i>	4 0.40 inch displays + 4 0.30 displays
<i>Operating temperature</i>	0-45 °C, humidity 35..95uR%
<i>Sealing</i>	IP65 front panel (with gasket) IP30 casing and IP20 terminals
<i>Material</i>	Polycarbonate UL94V0 self-extinguishing
<i>Weight</i>	100 g

3.2 Hardware Features

<i>Analogue input</i>	AN1 Configurable via software Input Thermocouple type K, S, R, J Automatic compensation of cold junction from 0 °C to 50 °C. Thermoresistance: PT100, PT500, PT1000, Ni100, PTC1K, NTC10K (β 3435K) Linear: 0-10V, 0-20 or 4-20mA, 0-40mV Potentiometers: 6K Ω , 150K Ω ,	Tolerance (25 °C) +/-0.2 % \pm 1 digit for thermocouple input, thermo resistance and V/mA. Cold junction accuracy 0.1 °C/°C
<i>Relay output</i>	2 relays (ATR142-ABC) 1 relay (ATR142-ABC-T) Configurable as command and/or alarm output	Contacts: Q1 – 8A-250V~ Q2 – 5A-250V~
<i>SSR output</i>	1 SSR Configurable as command output and/or alarm output.	12Vdc/30mA
<i>Supply</i>	Power supply 24..230 Vac/Vdc +/-15% 50/60Hz	Power consumption 3.5VA

3.3 Software Features

<i>Regulation algorithms</i>	ON-OFF with hysteresis. P, PI, PID, PD with proportional time
<i>Proportional band</i>	0...9999 °C or °F
<i>Integral time</i>	0,0...999,9 sec (0 excluded)
<i>Derivative time</i>	0,0...999,9 sec (0 excluded)
<i>Controller functions</i>	Manual or automatic Tuning, configurable alarms, protection of command and alarm setpoints, activation of functions via digital input, preset cycle with Start/Stop.

4 Dimensions and Installation

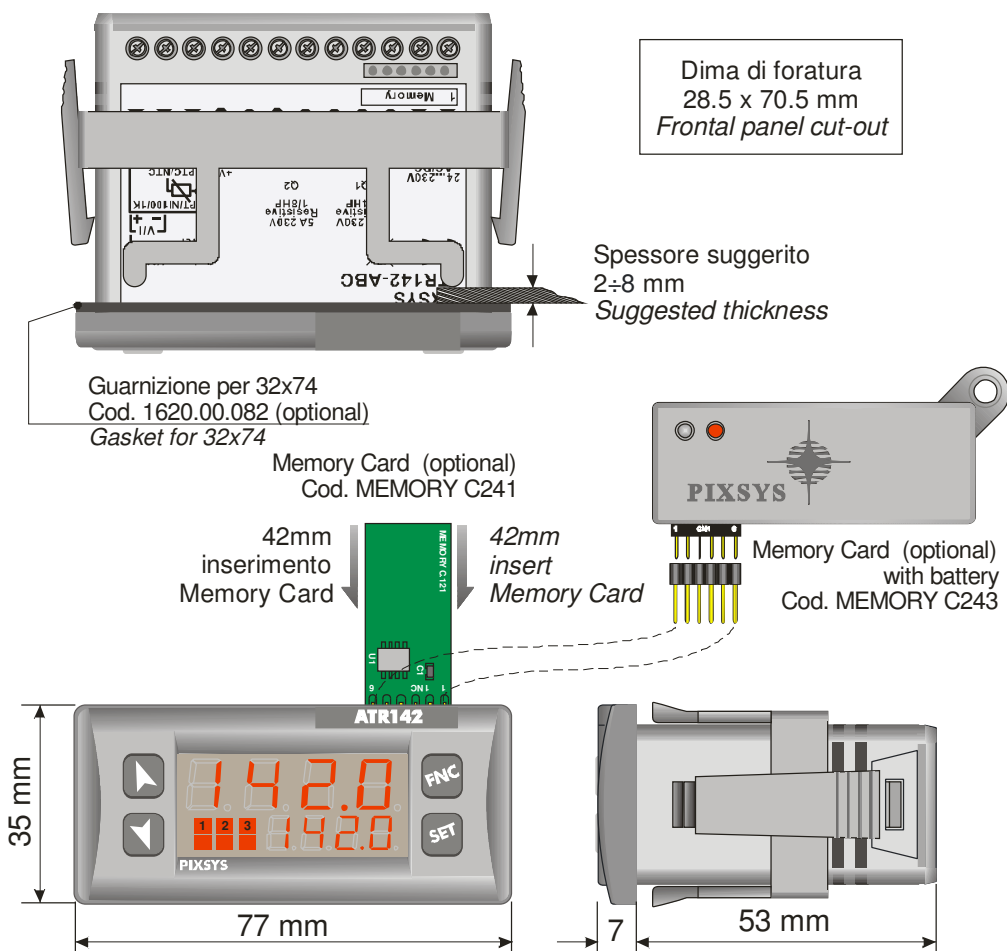

5 Electrical wirings



Although this controller was designed to resist noises in industrial environments, please notice following safety guidelines:

- Separate the feeder line from the power lines.
- Avoid placing near units with remote control switches, electromagnetic contactors, high powered motors and in all instances use specific filters.
- Avoid placing near power units, particularly if phase controlled.

5.1 Wiring diagram

The connections are reported below for the three models available.

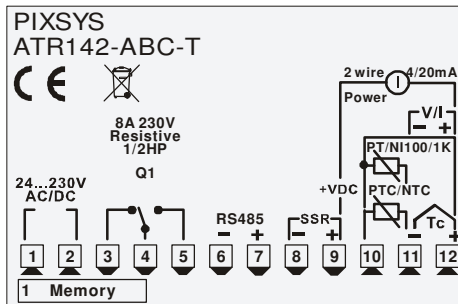
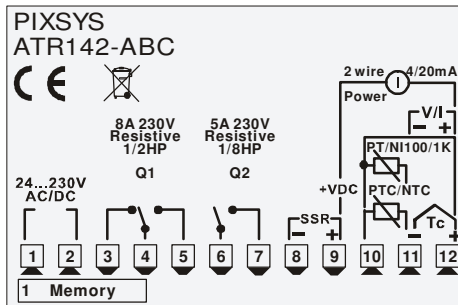

Power

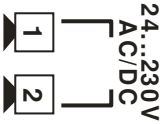

Switching power supply with extended range
24...230 Vac/dc $\pm 15\%$ 50/60Hz – 5,5VA.

AN1 Analogue Input

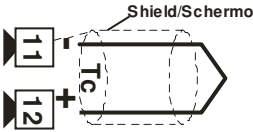

For thermocouples K, S, R, J.

- Comply with polarity
- For possible extensions, use a compensated wire and terminals suitable for the thermocouples used (compensated)
- When shielded cable is used, it should be grounded at one side only

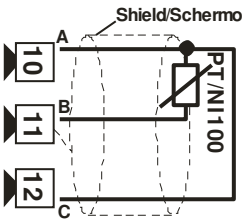

For thermoresistances PT100, NI100

- For the three-wire connection use wires with the same section
- For the two-wire connection short-circuit terminals 10 and 12
- When shielded cable is used, it should be grounded at one side only to avoid ground loop currents

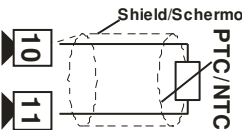
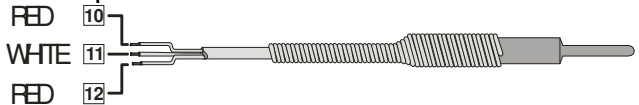

For thermoresistances NTC, PTC, PT500, PT1000 e potentiometers

- When shielded cable is used, it should be grounded at one side only to avoid ground loop currents

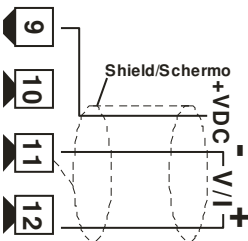

For linear signals V/mA

- Comply with polarity
- When shielded cable is used, it should be grounded at one side only to avoid ground loop currents

Examples of Connection for linear input

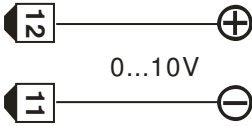

For signals 0...10V

- Comply with polarity

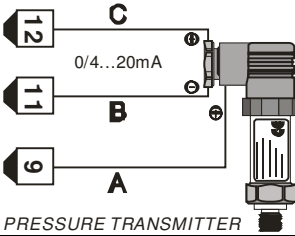

For signals 0/4...20mA with **three-wire sensor**

- Comply with polarity

C=Sensor output
B=Sensor ground
A=Sensor power

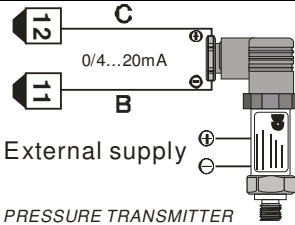

For signals 0/4...20mA with **external power of sensor**

- Comply with polarity

C=Sensor output
B=Sensor ground

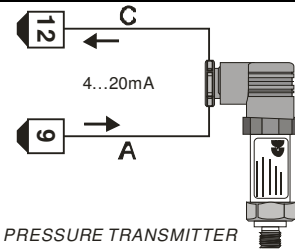

For signals 0/4...20mA with **two-wire sensor**

- Comply with polarity

C=Sensor output
A=Sensor power supply

Serial input

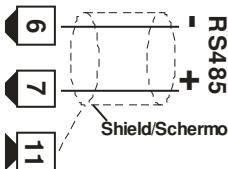



RS485 Modbus RTU communication









Do not use LT (line termination) resistors

- For networks with more than five instruments supply in low voltage









6.1 Numeric Indicators (Display)

1		Normally displays the process. During the configuration phase, it displays the parameter being inserted.
2		Normally displays the setpoint. During the configuration phase, it displays the parameter value being inserted.

6.2 Meaning of Status Lights (Led)

3		ON when the output command is on. For motorised valve command, led in on when valve is opening and blink when closing.
4		ON when alarm 1 is on.
5		ON when alarm 2 is on.
6		ON when the “Manual” function is on.
7		ON when the controller is running an “Autotune” cycle.
8		ON when the controller communicates via serial port.





6.3 Keys

9	 <ul style="list-style-type: none"> Allows to increase the main setpoint. During the configuration phase, allows to slide through parameters. Together with the  key it modifies them. Pressed after the  key it allows to increase the alarm setpoint.
10	 <ul style="list-style-type: none"> Allows to decrease the main setpoint. During the configuration phase, allows to slide through parameters. Together with the  key it modifies them. Pressed after the  key it allows to decrease the alarm setpoint.
11	 <ul style="list-style-type: none"> Allows to display the alarm setpoint and runs the autotuning function. Allows to vary the configuration parameters.
12	 <ul style="list-style-type: none"> Allows to display the alarm setpoint and runs the autotuning function. Allows to vary the configuration parameters.

7 Controller Functions

7.1 Modifying Main Setpoint and Alarm Setpoint Values

The setpoint value can be changed from the keyboard as follows:

	Press	Effect	Operation
1	 or 	Value on display 2 changes	Increases or decreases the main setpoint
2		Visualize alarm setpoint on display 1	
3	 or 	Value on display 2 changes	Increases or decreases the alarm set point value



7.2 Auto-Tune

The Tuning procedure calculates the controller parameters and can be manual or automatic according to selection on parameter 46 `tune`.

7.3 Manual Tuning

The manual procedure allows the user greater flexibility to decide when to update PID algorithm work parameters. The procedure can be activated in two ways.

- **By running Tuning from keyboard:**

Press the  key until display 1 shows the writing `tune` with display 2 showing `off`, press , display 2 shows `on`. The  led switches on and the procedure begins.

- **By running Tuning from digital input:**

Select `tune` on parameter 50 `dig. i.`.

On first activation of digital input (commutation on front panel) the  led switches on and on second activation switches off.





7.4 Automatic Tuning

Automatic tuning activates when the controller is switched on or when the setpoint is modified to a value over 35%.

To avoid an overshoot, the threshold where the controller calculates the new PID parameters is determined by the setpoint value minus the “Set Deviation Tune” (see Parameter 47 ).

To exit Tuning and leave the PID values unchanged, just press the



key until display 1 shows the writing  with the display showing , press , display 2 shows .

The  led switches off and the procedure finishes.

7.5 Soft Start

To reach the setpoint the controller can follow a gradient expressed in units (e.g. degree/hour).





Set the increase value in parameter 51  with the desired units/hour; only **on subsequent activation** the controller uses the soft start function.



Automatic/manual tuning cannot be enabled if the Soft start is active.

7.6 Automatic/Manual Regulation for % Output Control

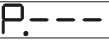

This function allows you to select automatic functioning or manual command of the output percentage.

With parameter 49 , you can select two methods.

- The first selection  allows you to enable the  key with the writing  on display 1, while display two shows .

Press the  key to show ; it is now possible, during the process display, to change the output percentage using the keys



and . To return to automatic mode, using the same procedure, select  on display 2: the  led switches off and functioning returns to automatic mode.

- The second selection **EnSt.** enables the same functioning, but with two important variants:
- If there is a temporary lack of voltage or after switch-off, the manual functioning will be maintained as well as the previously set output percentage value.
- If the sensor breaks during automatic functioning, the controller moves to manual mode while maintaining the output percentage command unchanged as generated by the PID immediately before breakage.

7.7 Pre-Programmed Cycle

The pre-programmed cycle function activates by setting **PrCy** in parameter 48 **OPNa**.

The controller reaches setpoint1 basing on the gradient set in parameter 51 **GrAd**, then it reaches maximum power up to setpoint2. When the process reaches maximum power, this setpoint is maintained for the time set in parameter 52 **MAE**.

On expiry, process will reach ambient temperature according to gradient entered on parameter 64 **FAGr**, then command output will be disabled and display will visualize **StOp**.

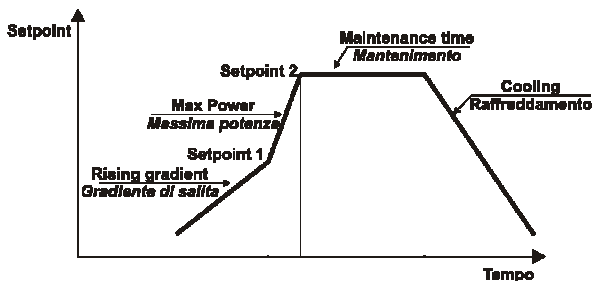

The cycle starts at each activation of the controller, or via digital input if it is enabled for this type of functioning (see parameter 50 **dGc.**).

7.8 Memory Card (optional)



Parameters and setpoint values can be duplicated from one controller to another using the Memory card.

There are two methods:

- ***With the controller connected to the power supply***

Insert the memory card **when the controller is off**.

On activation display 1 shows nEno and display 2 shows ----
(Only if the correct values are saved in the memory card). By

pressing the  key display 2 shows LOAD, then confirm using the  key. The controller loads the new data and starts again.



- ***With the controller not connected to power supply.***

The memory card is equipped with an internal battery with an autonomy of about 1000 uses.

Insert the memory card and press the programming buttons.

When writing the parameters, the led turns red and on completing the procedure it changes to green. It is possible to repeat the procedure without any particular attention.

Updating Memory Card

To *update* the memory card values, follow the procedure described in the first method, setting display 2 to ---- so as not to load the parameters on controller².





Enter configuration and **change at least one parameter**.

Exit configuration. Changes are saved automatically.

² If on activation the controller does not display nEno it means no data have been saved on the memory card, but it is possible to update values.

7.9 Loading default values

This procedure makes it possible to restore factory settings of the instrument.

	Premere	Effetto	Eeguire
1	 for 3 seconds.	Display 1 shows 0000 with the 1st digit flashing, while display 2 shows PASS	
2	 or 	Change the flashing digit and move to the next one using the  key.	Enter password 9999
3	 to confirm	Instrument loads default settings	Turn off and on the instrument







8 LATCH ON Functions

For use with input Pat. 1 (potentiometer 6KΩ) and Pat. 2 (potentiometer 150KΩ) and with linear input (0...10V, 0...40mV, 0/4...20mA), you can associate start value of the scale (parameter 6 Lol.) to the minimum position of the sensor and value of the scale end (parameter 7 UPL.) to the maximum position of the sensor (parameter 8 LAtc. configured as Std.).

It is also possible to fix the point in which the controller will display 0 (however keeping the scale range between Lol. and UPL.) using the “virtual zero” option by setting u0SE. or u0 in in parameter 8 LAtc.. If you set u0 in the virtual zero will reset after each activation of the tool; if you set u0SE. the virtual zero remains fixed once tuned.

To use the LATCH ON function configure as you wish the parameter **LAtc.**³

For the calibration procedure refer to the following table:

	Press	Effect	Operation
1		Exit parameters configuration. Display 2 shows the writing LAtc.	Position the sensor on the minimum functioning value (associated with LoL.)
2		Set the value to minimum. The display shows LoU	Position the sensor on the maximum functioning position (associated with UPL.)
3		Set the value to maximum. The display shows HIGH	To exit the standard procedure press  . For “virtual zero” settings position the sensor on the zero point.
4		Set the virtual zero value. The display shows U rE. N.B.: for selection of Uo in the procedure in point 4 should be followed on each re-activation.	To exit the procedure press  .



³ The tuning procedure starts by exiting the configuration after changing the parameter.

8.1 Digital Input Functions

Digital input is programmable for several functions which are useful to simplify controller operability. Select the desired function on parameter 50 `dGE.i`.

- Hold function (enabled by setting `Lcna` or `Lcnc`) allows to lock the reading of sensors when the digital input is active (useful for wide ranging oscillation on less significant values). During the lock phase, display 2 flashes and shows `Loct`.
- Enables/disables the autotuning function from digital input if the parameter `EUNE` is set on `NaN`.
- Enable regulation with `rna` or `rnc`.
- Switch from automatic to manual functioning if `AWNA` is set on `En` or `EnSE`.
- Start of pre-programmed cycle (see paragraph 7.7) with `SESE`.
- Change setpoint function.
This function is useful where there are 2 to 4 working thresholds required during system functioning without having to press the arrow keys.
To enable the function use the parameter `OPna`, by selecting the number of setpoints desired (no. thresholds switch). They can be switched during functioning by pressing the  key.

N.B.:

The digital input functions **are not** available with sensors PT100, NI100, NTC, PTC, PT500, PT1000 e potentiometers.

8.2 Dual Action Heating-Cooling

ATR142 is also suitable also for systems requiring a combined heating-cooling action.

The command output must be configured as Heating PID (`ACTE = HEAT` and with a `Pb` greater than 0), and one of the alarms (`AL. 1` or `AL. 2`) must be configured as `COOL`. The command output must be connected to the actuator responsible for heat, while the alarm will control cooling action.

The parameters to configure for the Heating PID are:

`ACTE = HEAT` Command output type (Heating)

`Pb`: Heating proportional band

`Et`: Integral time of heating and cooling

`Ed`: Derivative time of heating and cooling

`Ec`: Heating time cycle

The parameters to configure for the Cooling PID are the following (example: action associated to alarm1):

`AL. 1 = COOL` Alarm1 selection (cooling)

`Pbn`: Proportional band multiplier

`owdb`: Overlapping/Dead band

`cofc`: Cooling time cycle

The parameter `Pbn` (that ranges from 1.00 to 5.00) determines the proportional band of cooling basing on the formula:

Cooling proportional band = `Pb` * `Pbn`

This gives a proportional band for cooling which will be the same as heating band if `Pbn` = 1.00, or 5 times greater if `Pbn` = 5.00.

The **integral time and derivative time** are the same for both actions.

The parameter `owdb` determines the percentage overlapping between the two actions. For systems in which the heating output and cooling output must never be simultaneously active a dead band (`owdb` ≤ 0) must be configured, and vice versa you can configure an overlapping (`owdb` > 0).

The following figure shows an example of dual action PID (heating-cooling) with $E_i = 0$ and $E_d = 0$.

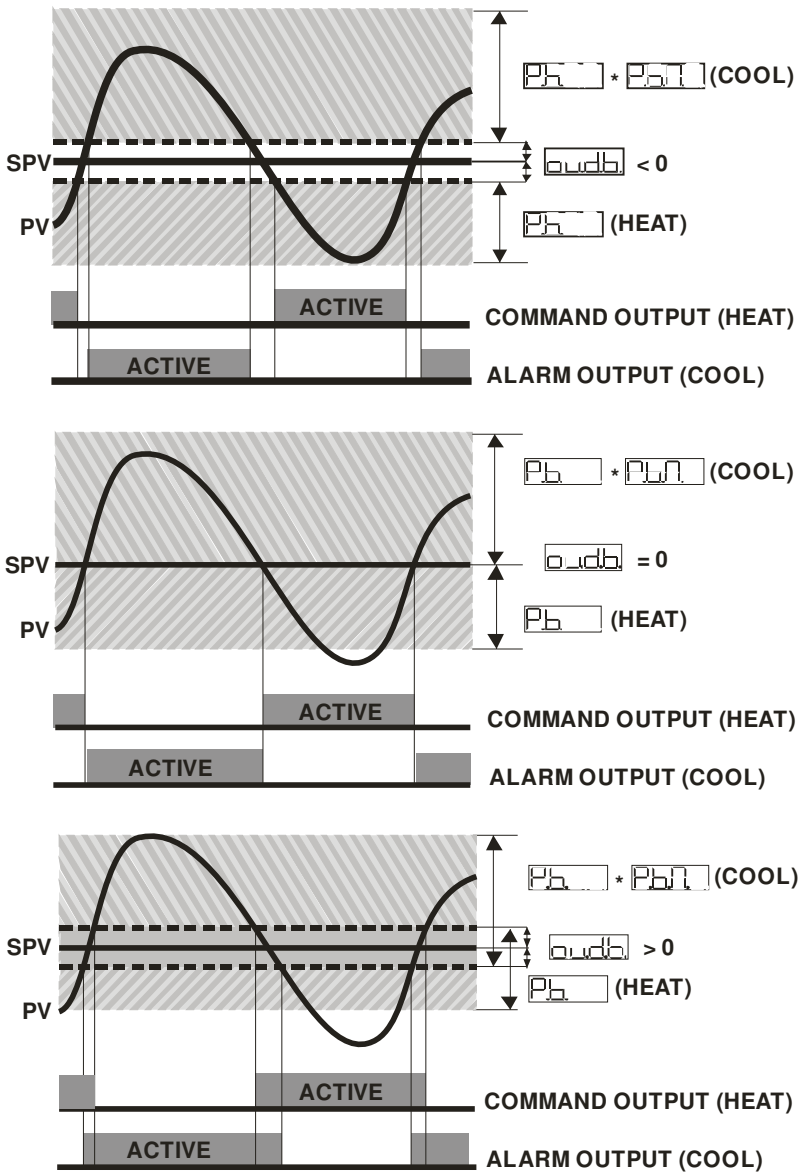

The parameter `catc` has the same meaning as the heating time cycle `tc`.

The parameter `coaf` (cooling fluid) pre-selects the proportional band multiplier `Pbn` and the cooling PID time cycle `catc` basing on the type of cooling fluid:

<code>coaf</code>	Cooling fluid type	<code>Pbn</code>	<code>catc</code>
Air	Air	1.00	10
oil	Oil	1.25	4
H ₂ O	Water	2.50	2

Once selected, the parameter `coaf`, the parameters `Pbn`, `audb` and `catc` can however be changed.

9 Serial Communication

9.1 Slave

ATR142-ABC-T, equipped with RS485, can receive and broadcast data via serial communication using MODBUS RTU protocol. The device operates as slave if parameter 59 `NASE` is set as `DIS`. This function enables the control of multiple controllers connected to a supervisory system (SCADA).

Each controller responds to a master query only if the query contains the same address as that in the parameter `SLAd`. The addresses permitted range from 1 to 254 and there must not be controllers with the same address on the same line.

Address 255 can be used by the master to communicate with all the connected equipment (broadcast mode), while with 0 all the devices receive the command, but no response is expected.

ATR142 can introduce a delay (in milliseconds) in the response to the master request. This delay must be set on parameter 58 `SEDE`.

Each parameter change is saved by the controller in the EEPROM memory (100000 writing cycles), while the setpoints are saved with a delay of ten seconds after the last change.

NB: Changes made to words that are different from those reported in the following table can lead to malfunction.

Modbus RTU protocol features

<i>Baud-rate</i>	Can be selected on parameter 70 <input type="text" value="bdr.t"/>
	<input type="text" value="48 F"/> 4800bit/sec
	<input type="text" value="96 F"/> 9600bit/sec
	<input type="text" value="192 F"/> 19200bit/sec
	<input type="text" value="288 F"/> 28800bit/sec
	<input type="text" value="384 F"/> 38400bit/sec
	<input type="text" value="576 F"/> 57600bit/sec
<i>Format</i>	8, N, 1 (8bit, no parity, 1 stop)
<i>Supported functions</i>	WORD READING (max 20 word) (0x03, 0x04) SINGLE WORD WRITING (0x06) MULTIPLE WORDS WRITING (max 20 word) (0x10)

The list below includes all the available addresses, where:





- RO** = Read Only
- R/W** = Read/Write
- WO** = Write Only

Modbus address	Description	Read Write	Reset value
0	Device type	RO	EEPROM
1	Software version	RO	EEPROM
5	Slave Address	R/W	EEPROM
6	Boot version	RO	EEPROM
50	Automatic addressing	WO	-
51	System code comparison	WO	-

500	Loading default values: 9999 restore all values 9998 restore all values except for baud-rate and slave address 9997 restore all values except for slave address 9996 restore all values except for baud-rate	WO	0
1000	Process (with tenths of degree for temperature sensors; digits for linear sensors)	RO	?
1001	Setpoint1	R/W	EEPROM
1002	Setpoint2	R/W	EEPROM
1003	Setpoint3	R/W	EEPROM
1004	Setpoint4	R/W	EEPROM
1005	Alarm1	R/W	EEPROM
1006	Alarm2	R/W	EEPROM
1007	Setpoint gradient	RO	EEPROM
1008	Outputs status (0=off, 1=on) Bit 0 = Q1 relay Bit 1 = Q2 relay Bit 2 = SSR	RO	0
1009	Heating output percentage (0-10000)	RO	0
1010	Cooling output percentage (0-10000)	RO	0
1011	Alarms status (0=none, 1=active) Bit0 = Alarm 1 Bit1 = Alarm 2	RO	0
1012	Manual reset: write 0 to reset all the alarms. In reading (0=not resettable, 1=resettable): Bit0 = Alarm 1 Bit1 = Alarm 2	WO	0

1013	Error flags Bit0 = Eeprom writing error Bit1 = Eeprom reading error Bit2 = Cold junction error Bit3 = Process error (sensor) Bit4 = Generic error Bit5 = Hardware error Bit6 = Master off-line Bit7 = Missing calibration data	RO	0
1014	Cold junction temperature (tenths of degree)	RO	?
1015	Start/Stop 0=controller in STOP 1=controller in START	R/W	0
1016	Lock conversion ON/OFF 0=Lock conversion off 1=Lock conversion on	R/W	0
1017	Tuning ON/OFF 0=Tuning off 1=Tuning on	R/W	0
1018	Automatic/manual selection 0=automatic 1>manual	R/W	0
1019	OFF LINE ¹ time (milliseconds)	R/W	0
1100	Process visualized (decimal as display)	RO	?
1101	Setpoint1 visualized (decimal as display)	R/W	EEPROM
1102	Setpoint2 visualized (decimal as display)	R/W	EEPROM
1103	Setpoint3 visualized (decimal as display)	R/W	EEPROM
1104	Setpoint4 visualized (decimal as display)	R/W	EEPROM

¹ If value is 0, the control is disabled. If different from 0, it is the max. time which can elapse between two pollings before the controller goes off-line.
If it goes off-line, the controller returns to Stop mode, the control output is disabled but the alarms are active.

1105	Allarme1 visualized (decimal as display)	R/W	EEPROM
1106	Allarme2 visualized (decimal as display)	R/W	EEPROM
1107	Setpoint gradient (decimal as display)	RO	EEPROM
1108	Heating output percentage (0-1000)	RO	0
1109	Heating output percentage (0-100)	RO	0
1110	Cooling output percentage (0-1000)	RO	0
1111	Cooling output percentage (0-100)	RO	0
2001	Parameter 1	R/W	EEPROM
...
2060	Parameter 60	R/W	EEPROM
3000	Disabling serial control of machine ²	WO	0
3001	First word display1 (ASCII)	R/W	0
.....	R/W	0
3008	Eighth word display1 (ASCII)	R/W	0
3009	First word display2 (ASCII)	R/W	0
.....	R/W	0
3016	Eighth word display2 (ASCII)	R/W	0
3017	Word LED Bit 0 = LED 1 Bit 1 = LED 2 Bit 2 = LED 3 Bit 3 = LED MAN Bit 4 = LED TUN Bit 5 = LED REM	R/W	0
3018	Word keys (write 1 to command keys) Bit 0 =  Bit 1 =  Bit 2 =  Bit 3 = 	R/W	0

² By writing 1 on this word, the effects of the writing are cancelled on all the Modbus addresses from 3001 to 3022. Control therefore returns to the controller.

3019	Word serial outputs Bit 0 = Q1 relay Bit 1 = Q2 relay Bit 2 = SSR	R/W	0
3020	Word serial outputs state if off-line Bit 0 = Q1 relay Bit 1 = Q2 relay Bit 2 = SSR	R/W	0
3021	Word serial process	R/W	0

9.2 Master

The device works as master if the value selected on parameter 59 **MAStE** is other than **d i S**.

9.2.1 Master Mode in retransmission

Selecting this mode, the device will write the value to be retransmitted at the address selected on parameter 60 **Addr** of the slave devices having same ID as the value selected on parameter 57 **SLAd**.

Regarding retransmission of setpoint values, after writing the value on slaves, ATR142 starts reading the corresponding word, so that any modification of value on the slave will be automatically updated also on the Master. Two successive pollings will be delayed for the time selected on parameter 57 **SEdE**.

The following table includes the options allowing the Master mode in retransmission and the relevant retransmitted value.

MAStE	Descrizione
UPrO Write Process	Write process value
rWcO Read/Write Command Setpoint	Write and read command setpoint value
UoWp Write Output Percentage	Write output percentage rated by P.I.D. function (Range 0-10000)
rWAl 1 Read/Write Alarm 1	Write and read alarm 1 setpoint value

The read/written value might be rescaled according to the proportion described in the following table:







NASE.	Limiti valore ingresso		Limiti valore riscaldato	
	Min.	Max.	Min.	Max.
UPro. Write Process	LoL.I. Lower Limit Input	uPL.I. Upper Limit Input	LoL.R. Lower Limit Retransmission	uPL.R. Upper Limit Retransmission
rUco. Read/Write Command Setpoint	LoL.S. Lower Limit Setpoint	uPL.S. Upper Limit Setpoint	LoL.R. Lower Limit Retransmission	uPL.R. Upper Limit Retransmission
Uou.P. Write Output Percentage	0	10000	LoL.R. Lower Limit Retransmission	uPL.R. Upper Limit Retransmission
rUA.1 Read/Write Alarm 1 Setpoint	LoL.S. Lower Limit Setpoint	uPL.S. Upper Limit Setpoint	LoL.R. Lower Limit Retransmission	uPL.R. Upper Limit Retransmission

The input value (included between minimum and max limit) is linearly converted into the retransmitted value which is included between min and max output value.

Rescaling is not executed if parameters **LoL.R.** and **uPL.R.** have the same value.

9.2.2 Master Mode Remote process















To enable this function it is necessary to select **rPro.** on parameter 59 **NASE.** In this mode the process value on ATR142 is a value read via serial communication. The ID of the slave must be same as value selected on parameter 57 **SLAd.** and the word to read is selected on parameter 60 **Addr.** Two successive pollings will be delayed for the time selected on parameter 57 **SEdE.** The read value might be rescaled according to the proportion described in the following table:

	Limits of read value		Limits of rescaled value	
	Min.	Max.	Min.	Max.
 Read Process	 Lower Limit Retransmission	 Upper Limit Retransmission	 Lower Limit Input	 Upper Limit Input

10 Configuration

10.1 Modify Configuration Parameter

For configuration parameters see paragraph 11.

	Press	Effect	Operation
1	 for 3 seconds.	Display 1 shows  with the 1st digit flashing, while display 2 shows  .	
2	 or 	Change the flashing digit and move to the next one using the  key.	Enter password 
3	 to confirm	Display 1 shows the first parameter and display 2 shows the value.	
4	 or 	Slide up/down through parameters	
5	 +  or 	Increase or decrease the value displayed by pressing firstly  and then an arrow key.	Enter the new data which will be saved on releasing the keys. To change another parameter return to point 4.
6		End of configuration parameter change. The controller exits from programming.	



















11 Table of Configuration Parameters

The following table includes all parameters. Some of them will not be visible on the models which are not provided with relevant hardware features.

no.	Display	Parameter description	Entering range		
1	<div style="border: 1px solid black; padding: 2px; display: inline-block;">c.o.2</div> Command Output	Select command output type	<div style="display: flex; flex-direction: column; align-items: flex-start;"> <div style="border: 1px solid black; padding: 2px; margin-bottom: 2px;">c. o 2</div> <div style="border: 1px solid black; padding: 2px; margin-bottom: 2px;">c. o 1</div> <div style="border: 1px solid black; padding: 2px; margin-bottom: 2px;">c.SSf</div> <div style="border: 1px solid black; padding: 2px;">c.uAL.</div> </div> Default		
ATR142-ABC					
	<i>COMMAND</i>	<i>ALARM 1</i>	<i>ALARM 2</i>		
<div style="border: 1px solid black; padding: 2px;">c. o 2</div>	Q2	Q1	SSR		
<div style="border: 1px solid black; padding: 2px;">c. o 1</div>	Q1	Q2	SSR		
<div style="border: 1px solid black; padding: 2px;">c.SSf</div>	SSR	Q1	Q2		
<div style="border: 1px solid black; padding: 2px;">c.uAL.</div>	Q1(opens) Q2(closes)	SSR	-		
ATR142-ABC-T					
	<i>COMMAND</i>	<i>ALARM 1</i>			
<div style="border: 1px solid black; padding: 2px;">c. o 1</div>	Q1	SSR			
<div style="border: 1px solid black; padding: 2px;">c.SSf</div>	SSR	Q1			
<div style="border: 1px solid black; padding: 2px;">c.uAL.</div>	Q1(opens) SSR(closes)	-			

no	Display	Parameter description	Entering range
2	SEn Sensor	Analog input configuration	Ec. F Tc-K (-260..1360°C) (Default) Ec. S Tc-S (-40..1760°C) Ec. r Tc-R (-40..1760°C) Ec. J Tc-J (-200..1200°C) PE PT100 (-200..600°C) PE 1 PT100 (-200..140°C) n 1 NI100 (-60...180°C) nEc NTC10K (-40..125°C) PEc PTC1K (-50...150°C) PEs PT500 (-100..600°C) PE 1F PT1000(-100..600°C) 0.10 0...10Volt 0.20 0...20mA 4.20 4...20mA 0.40 0...40mVolt Pot. 1 Potenz.Max6KΩ F.S. Pot.2 Potenz.Max 150KΩF.S.
3	dP. Decimal Point	Select number of displayed decimal points	0 Default 00 000 0000
4	L.L.S. Lower Limit Setpoint	Lower limit setpoint	-999...+9999 digit* (degrees if temperature) Default: 0.













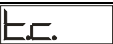

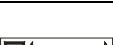

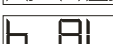
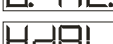
* The display of the decimal point depends on the setting of parameter **SEn** and the parameter **dP.**

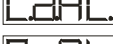
5	 Upper Limit Setpoint	Upper limit setpoint	-999...+9999 digit* (degrees if temperature) Default: 1750.
6	 Lower Linear Input	Lower range limit An1 only for linear input	-999...+9999 digit* Default: 0.
7	 Upper Linear Input	Upper range limit An1 only for linear input	-999...+9999 digit* Default: 1000.
8	 Latch On Function	Automatic setting of limits for Linear input	 (Disabled) Default  (Standard)  (Virtual Zero Stored)  (Virtual Zero Initialized)
9	 Offset Calibration	Offset calibration Number added to displayed value of process (normally corrects the room temperature value)	-999...+1000 digit* for linear sensors and potentiometers. -200.0...+100.0 tenths for temperature sensors. Default: 0.0.
10	 Gain Calibration	Gain calibration Value multiplied with process value to perform calibration on working point	-10.0%...+10.0% Default: 0.0.
11	 Action type	Regulation type	 : Heating (N.O.) Default  : Cooling (N.C.)  : HEat Off Over Setpoint
12	 Command Reset	Type of reset for state of command contact (always automatic in PID functioning)	 (Automatic Reset) Default  (Manual Reset)  (Manual Reset Stored)

13	<input type="text" value="SE"/> Command State Error	State of contact for command output in case of error	<input type="text" value="CO"/> Default <input type="text" value="CC"/>
14	<input type="text" value="LD"/> Command Led	State of the OUT1 led corresponding to the relevant contact	<input type="text" value="CO"/> Default <input type="text" value="CC"/>
15	<input type="text" value="HY"/> Command Hysteresis	Hysteresis in ON/OFF or dead band in P.I.D.	-999...+999 digits* (tenths of degree if temperature) Default: 0.0.
16	<input type="text" value="DE"/> Command Delay	Command delay (only in ON/OFF functioning). (In case of servo valve it also functions in PID and represents the delay between the opening and closure of the two contacts)	-180...+180 seconds (tenths of second in case of servo valve). Negative: delay in switching off phase. Positive: delay in activation phase. Default: 0.
17	<input type="text" value="SP"/> Command Setpoint Protection	Allows or not to change the command setpoint value	<input type="text" value="FrEE"/> Default <input type="text" value="Loct"/>
18	<input type="text" value="PB"/> Proportional Band	Proportional band Process inertia in units (E.g.: if temperature is in °C)	0 on/off if <input type="text" value="E. I."/> equal to 0 . Default 1-9999 digit* (degrees if temperature)

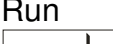
* The display of the decimal point depends on the setting of parameter

and parameter

19	 Integral Time	Integral time. Process inertia in seconds	0.0-999.9 seconds (0 integral disabled) Default: 0.
20	 Derivative Time	Derivative time. Normally ¼ the integral time	0.0-999.9 seconds (0 derivative disabled) Default: 0.
21	 Cycle Time	Cycle time (for PID on remote control switch 10/15sec, for PID on SSR 1 sec) or servo time (value declared by servo-motor manufacturer)	0.1-300.0 seconds Default: 10.0. For motorised valve minimum time in 1.0.
22	 Output Power Limit	Limit of output power %	10-100 % Default: 100.
23	 Alarm 1	Alarm 1 selection. Intervention of the alarm is associated with AL1	 (Disabled) Default  (Absolute Alarm)  (Band Alarm)  (High Deviation Alarm)  (Low Deviation Alarm)  (Absolute Com. setpoint Alarm)  (Start Alarm) Active in Run  (Cooling)  (Timer 1 Start Alarm)  (Timer 1 End Alarm)  (Timer 2 Start Alarm)  (Timer 2 End Alarm)  (Timer 1-2 Start Alarm)  (Timer 1-2 End Alarm)

24	<input type="checkbox"/> A. ISa Alarm 1 State Output	Alarm 1 output contact and intervention type	<input type="checkbox"/> no S (n.o. start) Default Normally open, active at start <input type="checkbox"/> nc S (n.c. start) Normally closed, active at start <input type="checkbox"/> no E (n.o. threshold) Normally open, active on reaching alarm ⁴ <input type="checkbox"/> nc E (n.c. threshold) Normally closed on reaching alarm ⁴
25	<input type="checkbox"/> A. RE Alarm 1 Reset	Type of Reset for contact of alarm 1	<input type="checkbox"/> ArE (Automatic Reset) Default <input type="checkbox"/> MrE (Manual Reset) <input type="checkbox"/> MrES (Manual Reset Stored)
26	<input type="checkbox"/> A. ISE Alarm 1 State Error	State of contact for alarm 1 output in case of error	<input type="checkbox"/> ca Default <input type="checkbox"/> cc
27	<input type="checkbox"/> A. ILd Alarm 1 Led	State of the OUT2 led corresponding to the relative contact	<input type="checkbox"/> ca <input type="checkbox"/> cc Default
28	<input type="checkbox"/> A. IHY Alarm 1 Hysteresis	Alarm 1 hysteresis	-999...+999 digit* (tenths of degree if temperature). Default: 0.
29	<input type="checkbox"/> A. IDE Alarm 1 Delay	Alarm 1 delay	-180...+180 Seconds Negative: delay in alarm output phase. Positive: delay in alarm entry phase. Default: 0.

⁴ On activation, the output is inhibited if the controller is in alarm mode. Activates only if alarm condition reappears, after that it was restored.

* The display of the decimal point depends on the setting of parameter **SEn**

and parameter **dP**.















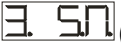

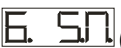



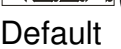

30	A.ISP. Alarm 1 Setpoint Protection	Alarm 1 set protection. Does not allow user to modify setpoint	FrEE Default Loct HiDE
31	AL. 2 Alarm 2	Alarm 2 selection. Alarm intervention is associated with AL2	d IS (Disabled) Default A. AL (Absolute Alarm) b. AL (Band Alarm) HdAL (High Deviation Alarm) LdAL (Low Deviation Alarm) AcAL (Absolute Command setpoint Alarm) StAL (Start Alarm) cool (Cooling) E. ISA (Timer 1 Start Alarm) E. IEA (Timer 1 End Alarm) E2SA (Timer 2 Start Alarm) E2EA (Timer 2 End Alarm) E. I2S (Timer 1-2 Start Alarm) E. I2E (Timer 1-2 End Alarm)
32	A2Sa Alarm 2 State Output	Alarm 2 output contact and intervention type	no S (n.o. start) Default Normally open, active at start nc. S (n.c. start) Normally closed, active at start no E (n.o. threshold) Normally open, active on reaching alarm ⁵ nc. E (n.c. threshold) Normally closed, active on reaching alarm ⁵

⁵ On activation, the output is inhibited if the controller is in alarm mode. It activates only if alarm condition reappears after that it was restored.



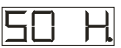
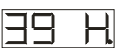



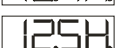





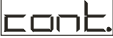



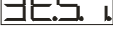

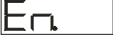



33	A2rE. Alarm 2 Reset	Type of Reset for contact of alarm 2	ArE. (Automatic Reset) Default MrE. (Manual Reset) MrES. (Manual Reset Stored)
34	A2SE. Alarm 2 State Error	State of contact for alarm 2 output in case of error	ca. Default cc.
35	A2Ld. Alarm 2 Led	State of OUT2 led corresponding to relative contact	ca. cc. Default
36	A2HY. Alarm 2 Hysteresis	Alarm 2 hysteresis	-999...+999 digit* (tenths of degree if temperature). Default: 0.
37	A2dE. Alarm 2 Delay	Alarm 2 delay	-180...+180 Seconds Negative: delay in alarm output phase. Positive: delay in alarm entry phase. Default: 0.
38	A2SP. Alarm 2 Setpoint Protection	Alarm 2 set protection. Does not allow operator to change value of setpoint	FrEE Default Loct HiDE
39	cooF. Cooling Fluid	Type of cooling fluid	Air Default oil H2o
40	PbN. Proportional Band Multiplier	Proportional band multiplier	1.00-5.00 Default: 1.00.

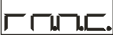

* The display of the decimal point depends on the setting of parameter **SEn.**



















and parameter **dP.**

41	 Overlap/Dead Band	Overlapping/Dead band	-20.0-50.0% Default: 0.
42	 Cooling Cycle Time	Cycle time for cooling output	1-300 seconds Default: 10.
43	 Conversion Filter	ADC filter: number of means on analog-digital conversions	 (Disabled)  (2 Samples Mean)  (3 Samples Mean)  (4 Samples Mean)  (5 Samples Mean)  (6 Samples Mean)  (7 Samples Mean)  (8 Samples Mean)  (9 Samples Mean)  (10 Samples Mean) Default  (11 Samples Mean)  (12 Samples Mean)  (13 Samples Mean)  (14 Samples Mean)  (15 Samples Mean)
44	 Conversion Frequency	Frequency of sampling of analog-digital converter	 (242 Hz)  (123 Hz)  (62 Hz)  (50 Hz)  (39 Hz)  (33.2 Hz)  (19.6 Hz)  (16.7 Hz) Default  (12.5 Hz)

			<input type="checkbox"/> 10 Hz (10 Hz) <input type="checkbox"/> 8.33 Hz (8.33 Hz) <input type="checkbox"/> 6.25 Hz (6.25 Hz) <input type="checkbox"/> 4.17 Hz (4.17 Hz)
45	<input type="checkbox"/> FLE Visualisation Filter	Visualisation filter	<input type="checkbox"/> DIS (Disabled) Default <input type="checkbox"/> PITCH (Pitchfork filter) <input type="checkbox"/> F1 (First Order) <input type="checkbox"/> F1P (First Order with Pitchfork) <input type="checkbox"/> 2 SN (2 Samples Mean) <input type="checkbox"/> 3 SN (3 Samples Mean) <input type="checkbox"/> 4 SN (4 Samples Mean) <input type="checkbox"/> 5 SN (5 Samples Mean) <input type="checkbox"/> 6 SN (6 Samples Mean) <input type="checkbox"/> 7 SN (7 Samples Mean) <input type="checkbox"/> 8 SN (8 Samples Mean) <input type="checkbox"/> 9 SN (9 Samples Mean) <input type="checkbox"/> 10 SN (10 Samples Mean)
46	<input type="checkbox"/> TUNE Tune	Tuning type selection	<input type="checkbox"/> DIS (Disabled) Default <input type="checkbox"/> AUTO (Automatic) PID parameters are calculated at activation and change of set. <input type="checkbox"/> MAN (Manual) Launch from keys or digital input.













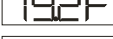

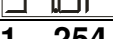
47	 Setpoint Deviation Tune	Select the deviation from the command setpoint, for the threshold used by autotuning to calculate the PID parameters	0-5000 digit* (tenths of degree if temperature). Default: 10.
48	 Operating Mode	Select operating mode	 (Controller) Default  (Programmed Cycle)  (2 Thresholds Switch)  (2 Thresholds Switch Impulsive)  (3 Thresholds Switch Impulsive)  (4 Thresholds Switch Impulsive)
49	 Automatic / Manual	Enable automatic/manual selection	 (Disabled) Default  (Enabled)  (Enabled Stored)
50	 Digital Input	Digital input functioning (P48 selection must be  or )	 (Disabled) Default: 0.  (Start/Stop)  (Run n.o.)  (Run n.c.)  (Lock Conversion n.o.)  (Lock Conversion n.c.)  (Tune) Manual  (Auto/Man. impulse)  (Auto/Man. Contact)

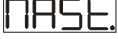

* The display of the decimal point depends on the setting of the parameter  and the parameter .



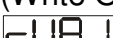



51	 Gradient	Increase gradient for soft start or pre-programmed cycle	0 disabled 1-9999 Digit/time* (degrees/hours with display of tenths if temperature) Default: 0.
52	 Maintenance Time	Maintenance time for pre-programmed cycle	00.00-24.00 hh.mm Default: 00.00.
53	 User Menu Cycle Programmed	Allows the rise gradient and the maintenance time to be changed from the user menu, in pre-programmed cycle functioning	 (Disabled) Default  (Rising Gradient)  (Maintenance Time)  (Rising Gradient and Maintenance Time)  (Falling Gradient)  (Rising and Falling Gradient)  (Falling Gradient and Maintenance Time)  (All)
54	 Visualization Type	Select visualization for display 1 and 2	 (1 Process, 2 Setpoint) Default  (1 Process, 2 Hide after 3 sec.)  (1 Setpoint, 2 Process)  (1 Setpoint, 2 Hide after 3 sec.)
55	 Degree	Select degree type	 : Centigrade - Default  : Fahrenheit

* The display of the decimal point depends on the setting of parameter 

and parameter 

56	 Baud Rate	Select baud rate for serial communication	   Default   
57	 Slave Address	Select slave address for serial communication	1 – 254 Default: 254.
58	 Serial Delay	Select serial delay	0 – 100 milliseconds Default: 20.
59	 Master	Select the master mode	 (Disable) Default  (Write Process)  (Read/Write Command Setpoint)  (Write Output Percentage)  (Read/Write Alarm 1 Setpoint)  (Read Process)
60	 Address Retransmission	Select address for retransmission	0x0000 – 0xFFFF (hexadecimal) Default: 0x03E9.
61	 Lower Limit Retransmission	Lower limit retransmission range	-999 – 9999 digit* (degrees if temperature) Default: 0.

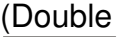
* The display of the decimal point depends on the setting of parameter  and parameter .

62	 Upper Limit Retransmission	Upper limit retransmission range ⁶	-999 – 9999 digit* (degrees if temperature) Default: 0.
63	 Timer Function ⁷	Enable 1 or 2 timers which may be set from user menu and which can be related to alarms	 (Disable) Default  (Single Timer Seconds)  (Double Timer Seconds)  (Single Timer Minutes)  (Double Timer Minutes)
64	 Falling Gradient ⁷	Cooling gradient for pre-programmed cycle	0 disabled (uncontrolled cooling) 1-9999 degrees/hour, with display of tenth Default: 0.

⁶ If parameter 61  and 62  have the same value, retransmitted value is not rescale.

⁷ Feature only available on specific request.

12 Alarm Intervention Modes

Absolute Alarm or Threshold Alarm ($\boxed{A. AL}$ selection)

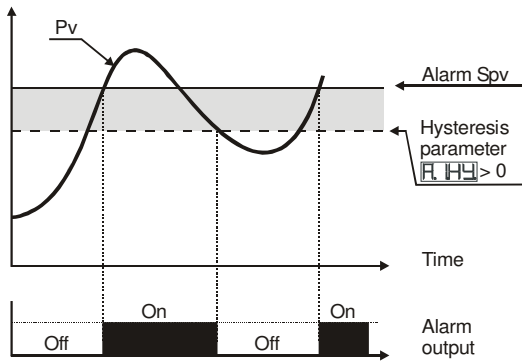

Absolute alarm with controller in heating functioning (Par.11 \boxed{ACEE} selected \boxed{HEAT}) and hysteresis value greater than "0" (Par.28 $\boxed{A. HY} > 0$).

N.B.: The example refers to alarm 1; the function can also be enabled for alarms 2 and 3 on models that include it.

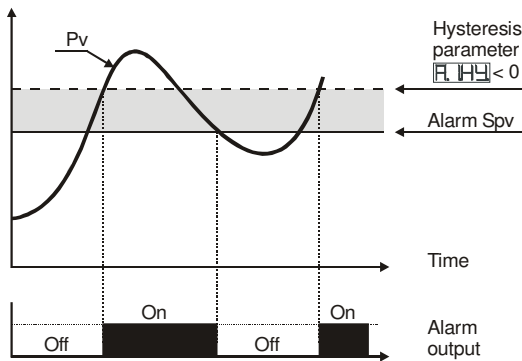

Absolute alarm with controller in heating functioning (Par.11 \boxed{ACEE} selected \boxed{HEAT}) and hysteresis value less than "0" (Par.28 $\boxed{A. HY} < 0$).

N.B.: The example refers to alarm 1; the function can also be enabled for alarms 2 and 3 on models that include it.

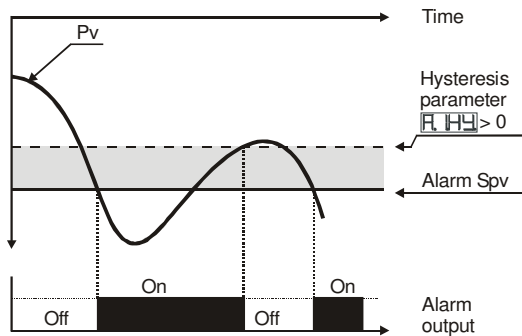

Absolute alarm with controller in cooling functioning (Par.11 \boxed{ACEE} selected \boxed{COOL}) and hysteresis value greater than "0" (Par.28 $\boxed{A. HY} > 0$).

N.B.: The example refers to alarm 1; the function can also be enabled for alarms 2 and 3 on models that include it.

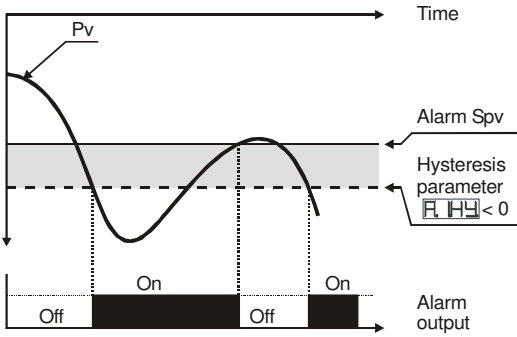

Absolute alarm with controller in cooling functioning (Par.11 **[ACEE]** selected **[COOL]**) and hysteresis value less than “0” (Par.28 **[A.HY]** < 0).

N.B.: The example refers to alarm 1; the function can also be enabled for alarms 2 and 3 on models that include it.

Absolute Alarm or Threshold Alarm Referring to Setpoint Command (**[ACAL]** selection)

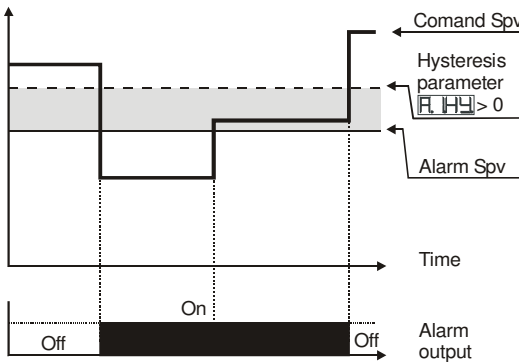

Absolute alarm refers to the command set, with the controller in heating functioning (Par.11 **[ACEE]** selected **[HEAT]**) and hysteresis value greater than “0” (Par.28 **[A.HY]** > 0). The command set can be changed by pressing the arrow keys on front panel or using serial port RS485 commands.

N.B.: The example refers to alarm 1; the function can also be enabled for alarms 2 and 3 on models that include it.

Band Alarm (B.AL selection)

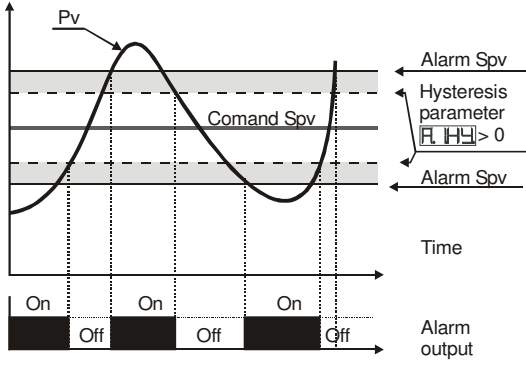

Band alarm hysteresis value greater than "0" (Par.28 $\text{A.HY} > 0$).

N.B.: The example refers to alarm 1; the function can also be enabled for alarms 2 and 3 on models that include it.

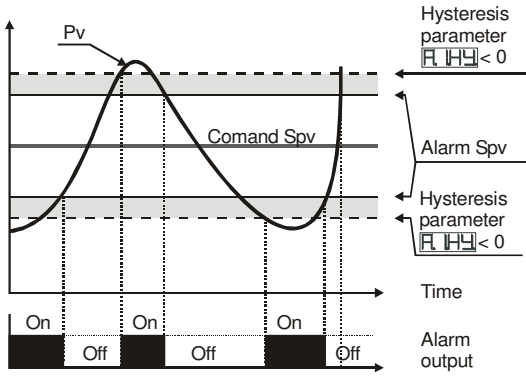

Band alarm hysteresis value less than "0" (Par.28 $\text{A.HY} < 0$).

N.B.: The example refers to alarm 1; the function can also be enabled for alarms 2 and 3 on models that include it.

Upper Deviation Alarm (HdAL selection)

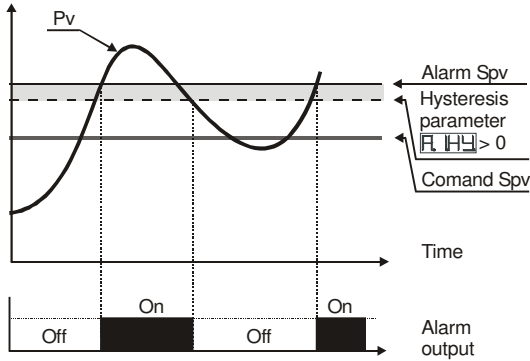

Upper deviation alarm value of alarm setpoint greater than "0" and hysteresis value greater than "0" (Par.28 $\overline{HdAL} > 0$).

N.B.:

a) The example refers to alarm 1; the function can also be enabled for alarms 2 and 3 on models that include it.

b) With hysteresis less than "0"

($\overline{HdAL} < 0$) the broken line moves above the alarm setpoint.

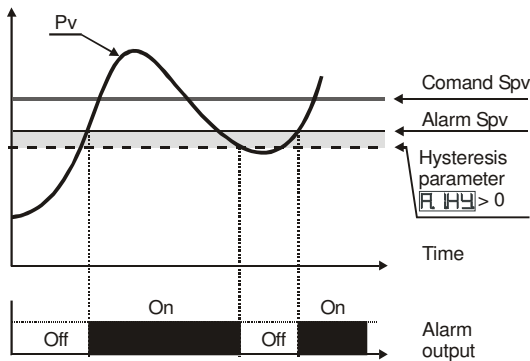

Upper deviation alarm value of alarm setpoint less than "0" and hysteresis value greater than "0" (Par.28 $\overline{HdAL} > 0$).

N.B.:

a) The example refers to alarm 1; the function can also be enabled for alarms 2 and 3 on models that include it.

b) With hysteresis less than "0"

($\overline{HdAL} < 0$) the broken line moves above the alarm setpoint.

Lower Deviation Alarm (HdAL selection)

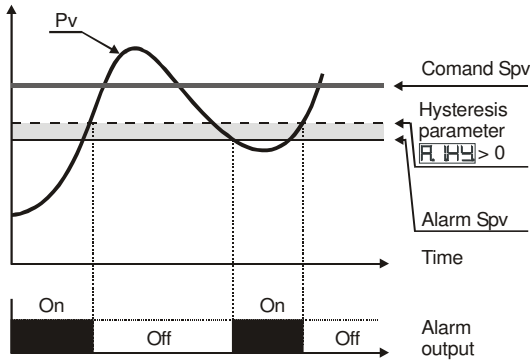

Lower deviation alarm value of alarm setpoint greater than "0" and hysteresis value greater than "0" (Par.28 $\overline{A.HY} > 0$).

N.B.:

a) The example refers to alarm 1; the function can also be enabled for alarms 2 and 3 on models that include it.

b) With hysteresis less than "0"

($\overline{A.HY} < 0$) the broken line moves under the alarm setpoint.

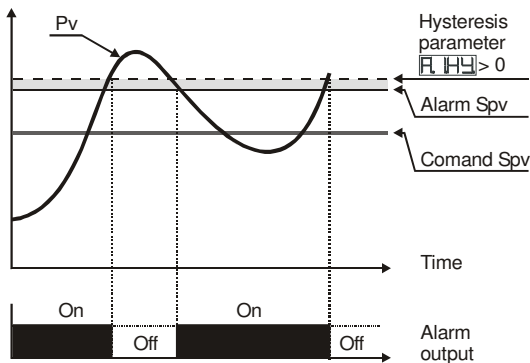

Lower deviation alarm value of alarm setpoint less than "0" and hysteresis value greater than "0" (Par.28 $\overline{A.HY} > 0$).

N.B.:

a) The example refers to alarm 1; the function can also be enabled for alarms 2 and 3 on models that include it

b) With hysteresis value less than "0"

($\overline{A.HY} < 0$) the broken line moves under the alarm setpoint.

13 Table of Anomaly Signals

In case of malfunctioning of the system, the controller switches off the regulation output and displays the type of anomaly.

For example the controller will signal the breakage of any connected thermocouple by displaying **E-05** (flashing) on display. For other notifications, see the table below.

#	Cause	What to do
E-01	Error in E ² PROM cell programming	Call Assistance
E-02	Cold junction sensor fault or room temperature outside of allowed limits.	Call Assistance
E-04	Incorrect configuration data. Possible loss of calibration values.	Check if the configuration parameters are correct.
E-05	Thermocouple open or temperature outside of limits.	Check the connection with the sensors and their integrity.
E-06	Off-line in master mode remote process	Check the serial connection, baud-rate and device ID .
E-08	Missing calibration data	Call Assistance

14 Summary of Configuration parameters

Date:	Model ATR142:
Installer:	System:
Notes:	

c.out	Command output type selection	
SEn	Analog input configuration	
dP.	Number of decimal points	
LoLS	Lower limit setpoint	
uPLS	Upper limit setpoint	
LoL₁	Lower limit range An1 only for linear	
uPL₁	Upper limit range An1 only for linear	
LAtc.	Automatic setting of linear input limits.	
ocAL.	Offset calibration	
GcAL.	Gain calibration	
Actt.	Regulation type	
c. rE.	Command output reset type	
c. SE.	Contact state for command output in case of error	
c. Ld	Define the OUT1 led state	
c. HY	Hysteresis in ON/OFF or dead band in P.I.D.	
c. dE.	Command delay	
c. SP.	Command setpoint protection	
Pb	Proportional band	
t_i	Integral time	
t_d	Derivative time	
t_c	Cycle time	
oPoL.	Limit of output power %	
AL₁	Alarm 1 selection	
A₁So	Alarm 1 output contact and intervention type	
A₁rE.	Reset type of alarm 1 contact.	
A₁SE.	State of contact for alarm 1 output	
A₁Ld	State of OUT2 led	

A1HY	Alarm 1 hysteresis	
A1DE	Alarm1 delay	
A1SP	Alarm 1 set protection	
AL2	Alarm 2 selection	
A2SO	Alarm 2 output contact and intervention type	
A2RE	Reset type of alarm 2 contact	
A2SE	State of contact for alarm 2 output	
A2LD	State of OUT2 led	
A2HY	Alarm 2 hysteresis	
A2DE	Alarm 2 delay	
A2SP	Alarm 2 set protection	
COOF	Cooling fluid type	
PbN	Proportional band multiplier	
owdb	Overlapping/Dead band	
COtc	Cycle time for cooling output	
CFLE	Analog converter filter	
CFcn	Sampling frequency of analog converter	
uFLE	Display filter	
tunE	Autotuning type selection	
Sdtu	Command setpoint deviation for tuning threshold	
oPNa	Operating mode	
AuNA	Automatic/manual selection	
dGE _v	Digital input functioning	
GrAd	Gradient for soft start	
NAE _v	Cycle maintenance time	
uNcP	Gradient change and maintenance time by user	
u tY	Display data selection	
dEGr	Degree type selection	
bdrE	Select baud rate for serial communication	
SLAd	Select slave address	
SEDE	Select the serial delay	
NASE	Select value to retransmit by ModBus	
Addr	Select address for retransmission	

15 Introduzione

Grazie per aver scelto un regolatore Pixsys.

Con il modello ATR142 Pixsys rende disponibile in un singolo strumento tutte le opzioni relative alla connessione dei sensori e al comando di attuatori, con in aggiunta un'utile alimentazione a range esteso da 24...230 Vac/Vdc. Con le 17 sonde selezionabili e l'uscita configurabile come relè o SSR l'utilizzatore o il rivenditore può gestire al meglio le scorte di magazzino razionalizzando investimento e disponibilità dei dispositivi. La serie si completa con i modelli dotati di comunicazione seriale RS485 Modbus Rtu. La ripetibilità in serie delle operazioni di parametrizzazione è ulteriormente semplificata dalle nuove Memory Card, dotate di batteria interna che non richiedono cablaggio per alimentare il regolatore.

16 Identificazione del modello

La famiglia di regolatori ATR142 prevede due versioni, facendo riferimento alla tabella seguente è facile risalire al modello desiderato.

Modelli con alimentazione 24...230 Vac/Vdc $\pm 15\%$ 50/60Hz - 3,5VA

ATR142-ABC	2 Relè (8A+5A) + 1 SSR
ATR142-ABC-T	1 Relè 8A + 1 SSR + RS485

17 Dati tecnici

17.1 Caratteristiche generali

<i>Visualizzatori</i>	4 display 0,40 pollici + 4 display 0,30 pollici
<i>Temperatura di esercizio</i>	temperatura funzionamento 0-45 °C, umidità 35..95uR%
<i>Protezione</i>	IP65 (con guarnizione) su Frontale, contenitore IP30 e morsettiere IP20
<i>Materiale</i>	Policarbonato UL94VO autoestinguente
<i>Peso</i>	Circa 100 g

17.2 Caratteristiche hardware

<i>Ingresso analogici</i>	AN1 Configurabile via software Ingresso Termocoppie tipo K, S, R, J Compensazione automatica del giunto freddo da 0 ... 50 °C. Termoresistenze: PT100, PT500, PT1000, Ni100, PTC1K, NTC10K (β 3435K) Ingresso V/I: 0-10V, 0-20 o 4-20mA, 0-40mV Ingresso Pot: 6K Ω , 150K Ω	Tolleranza (25 °C) +/-0.2 % \pm 1 digit per ingresso termocoppia, termoresistenza e V/mA. Precisione giunto freddo 0.1 °C/°C
<i>Uscite relè</i>	2 relè (ATR142-ABC) 1 relè (ATR142-ABC-T) Configurabili come uscita comando e allarme.	Contatti: Q1 – 8A-250V~ Q2 – 5A-250V~
<i>Uscita SSR</i>	1 SSR Configurabili come uscita comando e allarme.	12Vdc/30mA
<i>Alimentazione</i>	Alimentazione a range esteso 24...230Vac/Vdc \pm 15% 50/60Hz	Consumo: 3.5VA

17.3 Caratteristiche software

<i>Algoritmi regolazione</i>	ON-OFF con isteresi. P, PI, PID, PD a tempo proporzionale
<i>Banda proporzionale</i>	0...9999 °C o °F
<i>Tempo integrale</i>	0,0...999,9 sec (0 esclude)
<i>Tempo derivativo</i>	0,0...999,9 sec (0 esclude)
<i>Funzioni del regolatore</i>	Tuning manuale o automatico allarme selezionabile, protezione set comando e allarme, selezione funzioni da ingresso digitale, ciclo preprogrammato con Start/Stop.

18 Dimensioni e installazione

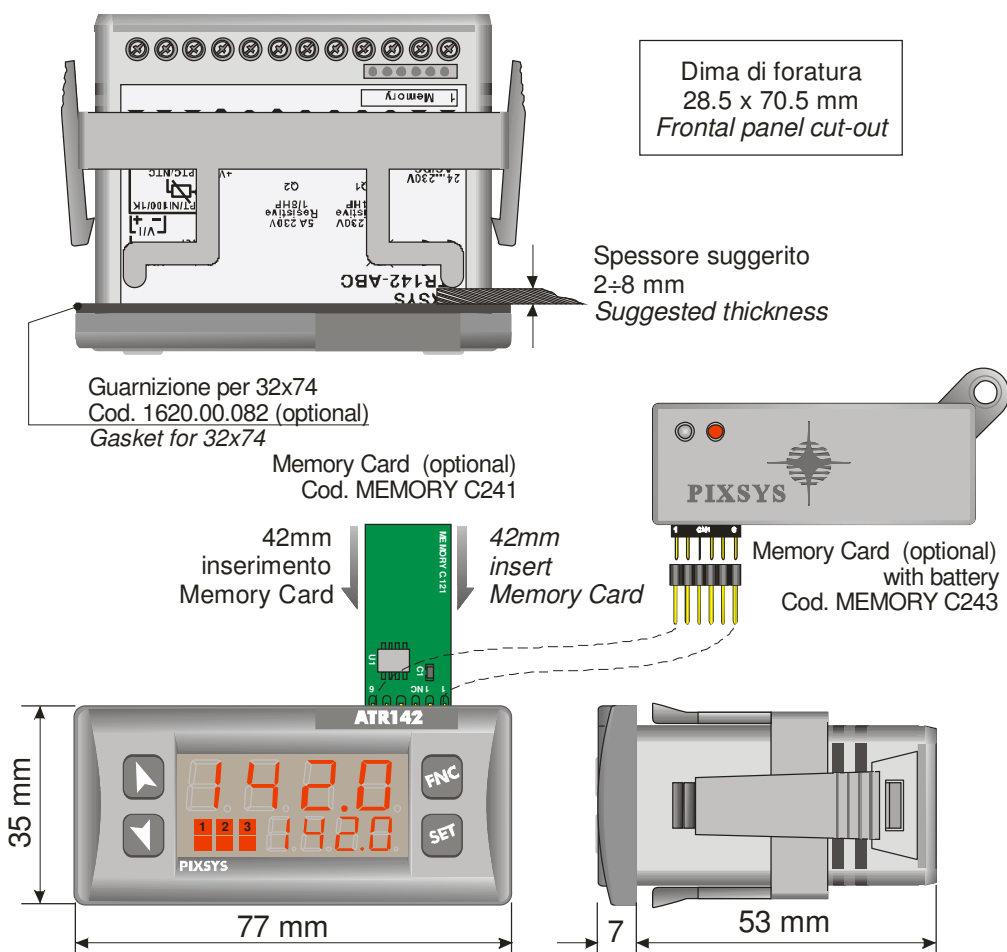

19 Collegamenti elettrici



Benché questo regolatore sia stato progettato per resistere ai più gravosi disturbi presenti in ambienti industriali è buona norma seguire la seguenti precauzioni:

- Distinguere la linea di alimentazioni da quelle di potenza.
- Evitare la vicinanza di gruppi di teleruttori, contattori elettromagnetici, motori di grossa potenza e comunque usare gli appositi filtri.
- Evitare la vicinanza di gruppi di potenza, in particolare se a controllo di fase.

19.1 Schema di collegamento

Di seguito sono riportati i collegamenti dei due modelli disponibili.

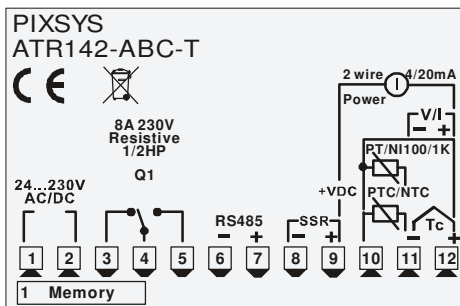
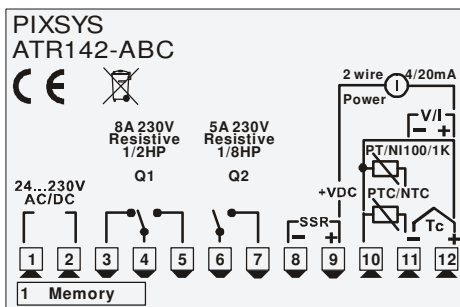

Alimentazione

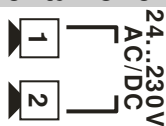

Alimentazione switching a range esteso
24...230 Vac/dc $\pm 15\%$ 50/60Hz – 3,5VA

Ingresso analogico AN1

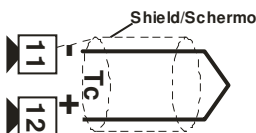

Per termocoppie K, S, R, J.

- Rispettare la polarità
- Per eventuali prolunghe utilizzare cavo compensato e morsetti adatti alla termocoppia utilizzata (compensati)
- Quando si usa cavo schermato, lo schermo deve essere collegato a terra ad una sola estremità

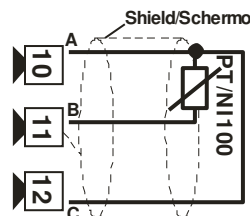

Per termoresistenze PT100, NI100

- Per il collegamento a tre fili usare cavi della stessa sezione.
- Per il collegamento a due fili cortocircuitare i morsetti 10 e 12.
- Quando si usa cavo schermato, lo schermo deve essere collegato a terra ad una sola estremità

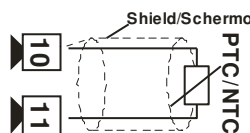
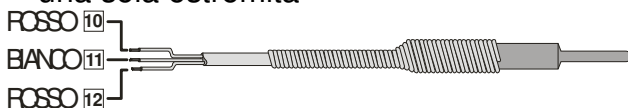

Per termoresistenze NTC, PTC, PT500, PT1000 e potenziometri lineari.

- Quando si usa cavo schermato, lo schermo deve essere collegato a terra ad una sola estremità

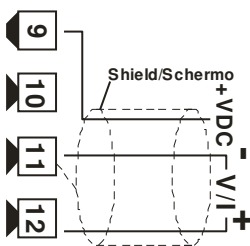

Per segnali normalizzati in corrente e tensione

- Rispettare la polarità
- Quando si usa cavo schermato, lo schermo deve essere collegato a terra ad una sola estremità

Esempi di collegamento per ingressi normalizzati

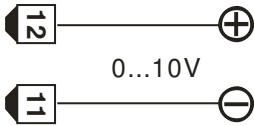

Per segnali normalizzati in tensione 0...10V

- Rispettare le polarità

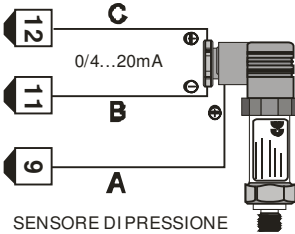

Per segnali normalizzati in corrente 0/4...20mA con **sensore a tre fili**

- Rispettare le polarità

C=Uscita sensore

B=Massa sensore

A=Alimentazione sensore

SENSORE DI PRESSIONE

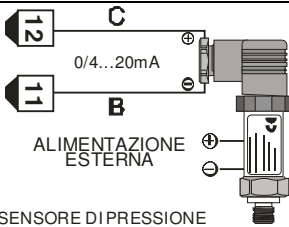

Per segnali normalizzati in corrente 0/4...20mA con **sensore ad alimentazione esterna**

- Rispettare le polarità

C=Uscita sensore

B=Massa sensore

SENSORE DI PRESSIONE

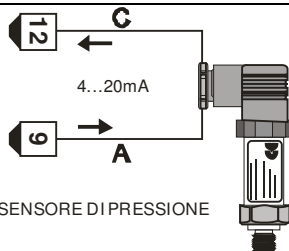

Per segnali normalizzati in corrente 0/4...20mA con **sensore a due fili**

- Rispettare le polarità

C=Uscita sensore

A=Alimentazione sensore

SENSORE DI PRESSIONE

Ingresso Seriale

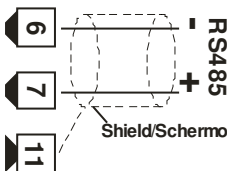

RS485, protocol MODBUS-RTU



Non usare resistenze di terminazione

- Per reti con più di cinque strumenti alimentare in bassa tensione

Uscite relè

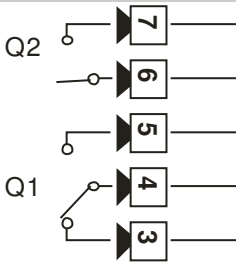

Portata contatti:

Q1 – 8A/250V~ per carichi resistivi

Q2 – 5A/250V~ per carichi resistivi

Uscita SSR

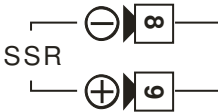

Uscita comando SSR portata 12V/30mA

Ingresso digitale





Ingresso digitale (parametro).

L'utilizzo dell'ingresso digitale è possibile solo con sonde tipo Tc, 0...10V, 0/4...20mA e 0...40mV.

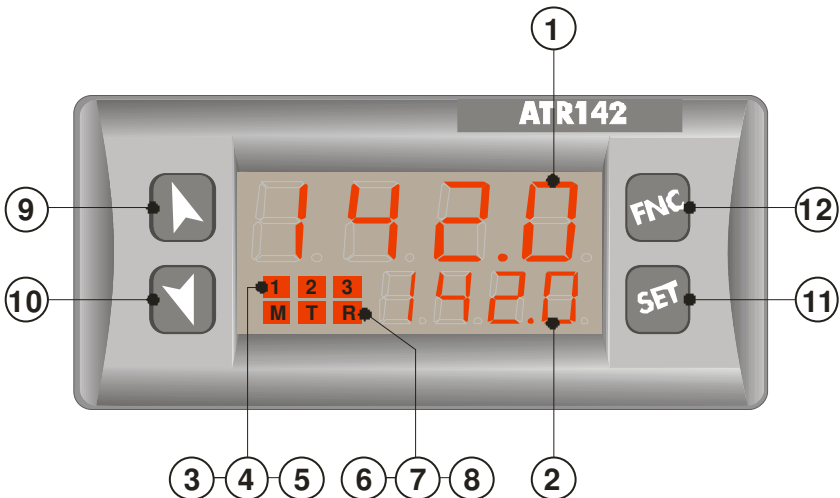





20 Funzione dei visualizzatori e tasti











20.1 Indicatori numerici (display)

1		Normalmente visualizza il processo. In fase di configurazione visualizza il parametro in inserimento.
2		Normalmente visualizza i setpoint. In fase di configurazione visualizza il valore del parametro in inserimento.

20.2 Significato delle spie di stato (led)

3		Si accendono quando l'uscita comando è attiva. Nel caso di comando valvola motorizzata è acceso nel caso di apertura valvola e lampeggia in chiusura.
4		Si accende quando l'allarme 1 è attivo.
5		Si accende quando l'allarme 2 è attivo.
6		Si accende all'attivazione della funzione "Manuale".
7		Si accende quando il regolatore sta eseguendo un ciclo di Tuning.
8		Si accende quando il regolatore comunica via seriale.





20.3 Tasti

9		<ul style="list-style-type: none"> Incrementa il setpoint principale In fase di configurazione consente di scorrere i parametri. Insieme al tasto  li modifica. Premuto dopo il tasto  incrementa i setpoint di allarme.
10		<ul style="list-style-type: none"> Decrementa il setpoint principale In fase di configurazione consente di scorrere i parametri. Insieme al tasto  li modifica. Premuto dopo il tasto  decrementa i setpoint di allarme.
11		<ul style="list-style-type: none"> Permette di visualizzare i setpoint di allarme. Permette di variare i parametri di configurazione.
12		<ul style="list-style-type: none"> Permette di entrare nella funzione di lancio del Tuning, selezione automatico/manuale. Permette di variare i parametri di configurazione.

21 Funzioni del regolatore

21.1 Modifica valore setpoint principale e setpoint di allarme

Il valore dei setpoint può essere modificato da tastiera come segue:

	Premere	Effetto	Eeguire
1	 	La cifra sul display 2 varia	Incrementare o diminuire il valore del setpoint principale
2		Visualizza setpoint di allarme sul display 1	
3	 	La cifra sul display 2 varia	Incrementare o diminuire il valore del setpoint di allarme



21.2 Auto-tune

La procedura di Tuning per il calcolo dei parametri di regolazione può essere manuale o automatica e viene selezionata da parametro 46 TUNE.

21.3 Lancio del Tuning Manuale

La procedura manuale permette all'utente maggiore flessibilità nel decidere quando aggiornare i parametri di regolazione dell' algoritmo PID. La procedura può essere attivata in due modi.

- **Lancio del Tuning da tastiera:**

Premere il tasto  finché il display 1 non visualizza la scritta TUNE con il display 2 su OFF, premere  , il display 2 visualizza ON. Il led **T** si accende e la procedura ha inizio.

- **Lancio del Tune da ingresso digitale:**



Selezionare TUNE su parametro 50 DCB. I.



Alla prima attivazione dell'ingresso digitale (commutazione su fronte) il led **T** si accende, alla seconda si spegne.

21.4 Tuning Automatico

Il Tuning automatico si attiva all'accensione dello strumento o quando viene modificato il setpoint di un valore superiore al 35%.

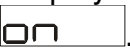
Per evitare overshoot, il punto dove il regolatore calcola i nuovi parametri PID è determinato dal valore di setpoint meno il valore "Set Deviation Tune" (vedere Parametro 47 )

Per interrompere il Tuning lasciando invariati i valori PID, premere il tasto  finché il display 1 non visualizza la scritta  e il display 2 visualizza .

Premendo , il display 2 visualizza , il led  si spegne e la procedura termina.

21.5 Soft Start

Il regolatore all'accensione per raggiungere il setpoint segue un gradiente di salita impostato in Unità (es. Grado / ora).

Impostare sul parametro 51  il valore di incremento in Unità/Ora desiderato; alla **successiva accensione** lo strumento eseguirà la funzione Soft Start.

Non può essere abilitata la funzione Tuning automatico e manuale se la funzione Soft Start è attiva.

21.6 Regolazione automatico / manuale per controllo % uscita

Questa funzione permette di passare dal funzionamento automatico al comando manuale della percentuale dell'uscita.

Con il parametro 49  è possibile selezionare due modalità.

- Selezione  (Enable).

Premendo il tasto  visualizza la scritta  sul display 1, mentre sul display 2 appare .

Premere il tasto  per selezionare la modalità manuale .

Con i tasti  e  variare la percentuale di uscita.

Per tornare in automatico, con la stessa procedura, selezionare **Auto** sul display 2: subito si spegne il led **M** e il funzionamento torna in automatico.

- Selezione **EnSt.** (enable stored)
Abilita lo stesso funzionamento, ma con due importanti varianti:
- Nel caso di temporanea mancanza di tensione o comunque dopo uno spegnimento, accendendo il regolatore verrà mantenuto sia il funzionamento in manuale, sia il valore di percentuale dell'uscita precedentemente impostato.
- Nel caso di rottura del sensore durante il funzionamento automatico, il regolatore si porterà in manuale mantenendo invariata la percentuale di uscita comando generata dal PID subito prima della rottura.

21.7 Ciclo pre-programmato

Questa funzione permette di programmare un semplice ciclo di lavoro temporizzato, e si abilita impostando **Prcy** nel parametro 48 **OPNa**: il processo raggiunge il setpoint1 in base al gradiente impostato nel parametro 51 **GrAd**, poi sale alla massima potenza verso il setpoint 2. Quando il processo raggiunge il setpoint 2 in mantenimento per il tempo impostato nel parametro 52 **MAE**. Allo scadere, il processo raggiunge la temperatura ambiente in base al gradiente impostato nel parametro 64 **FAGr**, e poi l'uscita di comando viene disabilitata e lo strumento visualizza **Stop**.

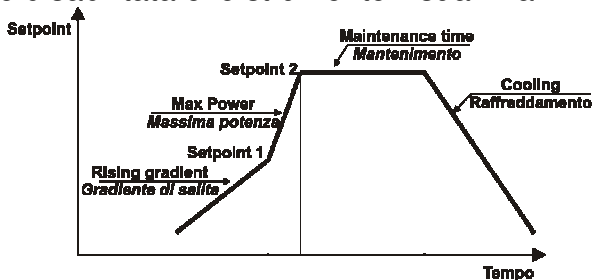

Lo Start del ciclo avviene ad ogni accensione dello strumento, oppure da ingresso digitale se risulta abilitato per questo tipo di funzionamento (vedi parametro 50 **DGE**).

21.8 Memory Card (opzionale)

E' possibile duplicare parametri e setpoint da un regolatore ad un altro mediante l'uso della Memory Card.

Sono previste due modalità:

- **Con regolatore connesso all'alimentazione:**

Inserire la Memory Card con regolatore spento.

All'accensione il display 1 visualizza **MEMO** e il display 2 visualizza **----** (Solo se nella Memory sono salvati valori corretti).

Premendo il tasto  il display 2 visualizza **LOAD**.

Confermare con il tasto .

Il regolatore carica i nuovi valori e riparte.



- **Con regolatore non connesso all'alimentazione:**

La memory card è dotata di batteria interna con autonomia per circa 1000 utilizzi.

Inserire la memory card e premere il tasto di programmazione.

Durante la scrittura dei parametri il led si accende rosso, al termine della procedura si accende verde. E' possibile ripetere la procedura senza particolari attenzioni.

Aggiornamento Memory Card.

Per *aggiornare* i valori della Memory seguire il procedimento descritto nella prima modalità, impostando **----** sul display 2 in modo da non caricare i parametri sul regolatore².





Entrare in configurazione e **variare almeno un parametro**.

Uscendo dalla configurazione il salvataggio sarà automatico.

² Nel caso in cui all'accensione il regolatore non visualizzi **MEMO** significa che non ci sono dati salvati nella Memory Card, ma è possibile ugualmente aggiornarne i valori.

21.9 Caricamento valori di default

Questa procedura permette di ripristinare le impostazioni di fabbrica dello strumento.

	Premere	Effetto	Eseguire
1	 per 3 secondi.	Su display 1 compare 0000 con la 1° cifra lampeggiante, mentre sul display 2 compare PASS .	
2	 o 	Si modifica la cifra lampeggiante si passa alla successiva con il tasto 	Inserire la password 9999
3	 per conferma	Lo strumento carica le impostazioni di fabbrica	Spegnere e riaccendere lo strumento







22 Funzioni LATCH ON

Per l'impiego con ingresso **Pot. 1** (pot. 6K Ω) e **Pot. 2** (pot. 150K Ω) e con ingressi normalizzati (0...10V, 0...40mV, 0/4...20mA), è possibile associare il valore di inizio scala (parametro 6 **Lcl.**) alla posizione di minimo del sensore e quello di fine scala (parametro 7 **UPL.**) alla posizione di massimo del sensore (parametro 8 **LAtc.** configurato come **Std.**).

E' inoltre possibile fissare il punto in cui lo strumento visualizzerà 0 (mantenendo comunque il campo scala compreso tra **Lcl.** e **UPL.**) tramite l'opzione di "zero virtuale" impostando **00SE** oppure **00 in** nel parametro 8 **LAtc.**. Se si imposta **00 in** lo zero virtuale andrà reimpostato dopo ogni accensione dello strumento; se si imposta **00SE** lo zero virtuale resterà fisso una volta tarato.

Per utilizzare la funzione LATCH ON configurare come desiderato il parametro **LATE.**⁸

Per la procedura di taratura fare riferimento alla seguente tabella:











	Premere	Effetto	Eeguire
1		Esce dalla configurazione parametri. Il display 2 visualizza la scritta LATE.	Posizionare il sensore sul valore minimo di funzionamento (associato a LOW)
2		Fissa il valore sul minimo. Il display visualizza LOW	Posizionare il sensore sul valore massimo di funzionamento (associato a UPL)
3		Fissa il valore sul massimo. Il display visualizza HIGH	Per uscire dalla procedura standard premere  Nel caso di impostazione con “zero virtuale” posizionare il sensore nel punto di zero.
4		Fissa il valore di zero virtuale. Il display visualizza URTE N.B.: nel caso di selezione LOW la procedura al punto 4 va eseguita ad ogni ri-accensione.	Per uscire dalla procedura tenere premuto  .

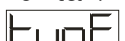

⁸ La procedura di taratura parte uscendo dalla configurazione dopo aver variato il parametro.

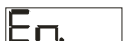
22.1 Funzioni da Ingresso digitale

L'utilizzo dell'ingresso digitale abilita alcune funzioni utili a semplificare l'operatività del regolatore. Selezionare la funzione desiderata sul parametro 50 .

1. Funzione Hold: si abilitata impostando  o  e permette di bloccare la lettura delle sonde quando l'ingresso digitale è attivo. Risulta utile quando la misura oscilla molto sui valori meno significativi. Durante la fase di blocco il display 2 lampeggia visualizzando .
2. Abilita / disabilita il Tuning da ingresso digitale se il parametro  è impostato su .
3. Abilita regolazione con  o .
4. Passa da funzionamento automatico a manuale se  è impostato su  o .
5. Start del ciclo preprogrammato con  (vedi paragrafo 7.7).
6. E' possibile utilizzare l'ingresso digitale per la funzione di "Cambio Setpoint".
Questo funzionamento è utile nel caso ci siano da 2 a 4 soglie di lavoro che si vogliono richiamare da pulsante senza dover agire sui tasti freccia durante il funzionamento dell'impianto.
Per abilitare la funzionalità agire sul parametro 48 , selezionando il numero di setpoint desiderati (n. Thresholds switch). Questi potranno essere impostati durante il funzionamento premendo il tasto .

N.B.: Le funzioni da ingresso digitale **non** sono disponibili con sonde PT100, NI100, NTC, PTC, PT500, PT1000 e potenziometri lineari.

22.2 Funzionamento in doppia azione (caldo-freddo)

L'ATR142 è adatto alla regolazione anche su impianti che prevedano un'azione combinata caldo-freddo.

L'uscita di comando deve essere configurata in PID caldo ($\boxed{ACTE} = \boxed{HEAT}$ e \boxed{PB} maggiore di 0), e uno degli allarmi ($\boxed{AL. 1}$ oppure $\boxed{AL. 2}$) deve essere configurato come \boxed{COOL} . L'uscita di comando va collegata all'attuatore responsabile dell'azione caldo, l'allarme comanderà invece l'azione refrigerante.

I parametri da configurare per il PID caldo sono:

$\boxed{ACTE} = \boxed{HEAT}$ Tipo azione uscita di comando (Caldo)

\boxed{PB} : Banda proporzionale azione caldo

\boxed{Ti} : Tempo integrale azione caldo ed azione freddo

\boxed{Td} : Tempo derivativo azione caldo ed azione freddo

\boxed{Tc} : Tempo di ciclo azione caldo

I parametri da configurare per il PID freddo sono (azione associata, per esempio, all'allarme1):

$\boxed{AL. 1} = \boxed{COOL}$ Selezione Allarme1 (Cooling)

\boxed{PbN} : Moltiplicatore di banda proporzionale

\boxed{owdb} : Sovrapposizione / Banda morta

\boxed{cotc} : Tempo di ciclo azione freddo

Il parametro \boxed{PbN} (che varia da 1.00 a 5.00) determina la banda proporzionale dell'azione refrigerante secondo la formula:

Banda proporzionale azione refrigerante = \boxed{PB} * \boxed{PbN}

Si avrà così una banda proporzionale per l'azione refrigerante che sarà uguale a quella dell'azione caldo se $\boxed{PbN} = 1.00$, o 5 volte più grande se $\boxed{PbN} = 5.00$.

Tempo integrale e Tempo derivativo sono gli stessi per entrambe le azioni.

Il parametro \boxed{owdb} determina la sovrapposizione in percentuale tra le due azioni. Per gli impianti in cui l'uscita riscaldante e l'uscita refrigerante non devono mai essere attive contemporaneamente si

configurerà una Banda morta ($\text{owdb} \leq 0$), viceversa si potrà configurare una sovrapposizione ($\text{owdb} > 0$).

La figura seguente riporta un esempio di PID doppia azione (caldo-freddo) con $\text{E}_i = 0$ e $\text{E}_d = 0$.

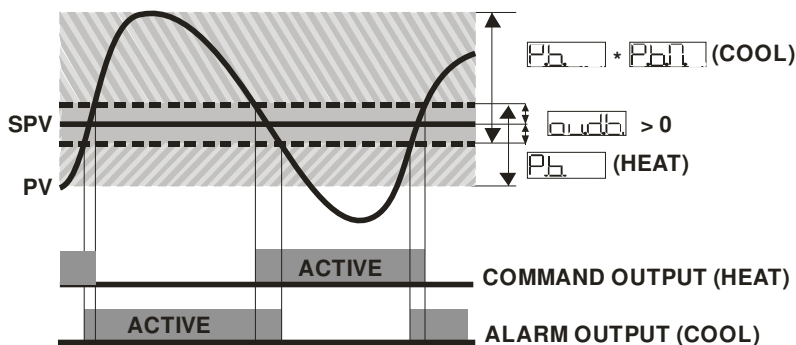
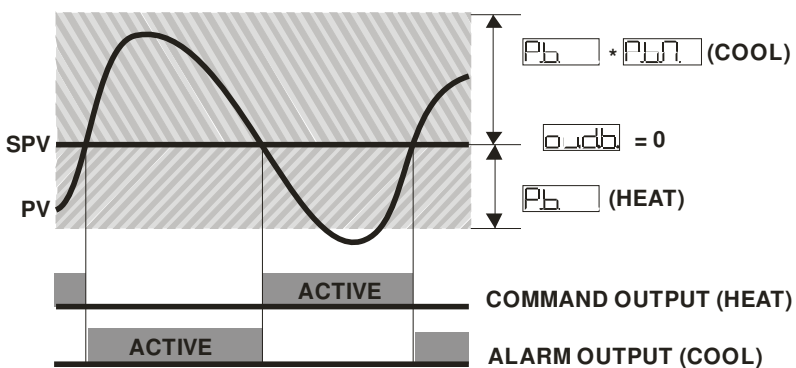
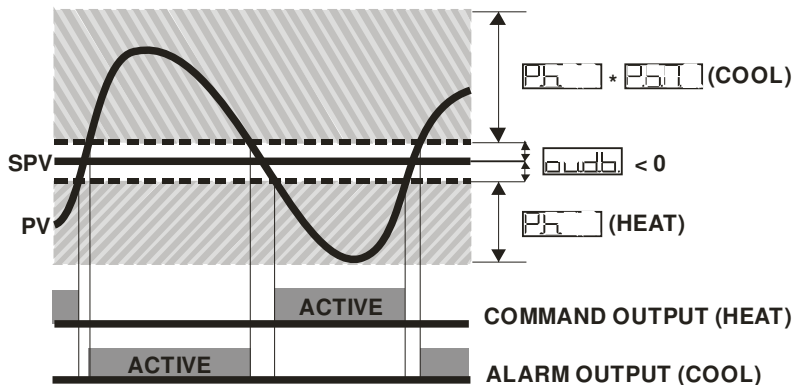

Il parametro **COFC** ha lo stesso significato del tempo di ciclo per l'azione caldo **TC**.

Il parametro **COAF** (Cooling Fluid) pre-seleziona il moltiplicatore di banda proporzionale **PbN** ed il tempo di ciclo **COFC** del PID freddo in base al tipo di fluido refrigerante:

COAF	Tipo di fluido refrigerante	PbN	COFC
Air	Aria	1.00	10
oil	Olio	1.25	4
H2O	Acqua	2.50	2

Una volta selezionato il parametro **COAF**, i parametri **PbN**, **OUTD** e **COFC** possono essere comunque modificati.

23 Comunicazione Seriale

23.1 Slave

L'ATR142-ABC-T con RS485 può ricevere e trasmettere dati via seriale tramite protocollo MODBUS RTU. Il dispositivo funziona come slave se il parametro 59 **MODE** è impostato su **DIS**. Questa funzione permette il controllo di più regolatori collegati ad un sistema di supervisione.

Ciascuno strumento risponderà ad un'interrogazione del Master solo se questa contiene l'indirizzo uguale a quello contenuto nel parametro **SLAD**. Gli indirizzi permessi vanno da 1 a 254 e non devono esserci regolatori con lo stesso indirizzo sulla stessa linea.

L'indirizzo 255 può essere usato dal Master per comunicare con tutte le apparecchiature collegate (modalità broadcast), mentre con 0 tutti i dispositivi ricevono il comando, ma non è prevista alcuna risposta.

L'ATR142 può introdurre un ritardo (in millisecondi) della risposta alla richiesta del Master. Tale ritardo deve essere impostato sul parametro 58 **SEDE**.

Ad ogni variazione dei parametri lo strumento salva il valore in memoria EEPROM (100000 cicli di scrittura), mentre il salvataggio dei setpoint avviene con un ritardo di 10 secondi dall'ultima modifica.

NB: Modifiche apportate a Word diverse da quelle riportate nella tabella seguente possono causare mal funzionamenti dello strumento.

Caratteristiche protocollo Modbus RTU

<i>Baud-rate</i>	Selezionabile da parametro 56 <input type="text" value="bdrE"/>
	<input type="text" value="48F"/> 4800bit/sec
	<input type="text" value="96F"/> 9600bit/sec
	<input type="text" value="192F"/> 19200bit/sec
	<input type="text" value="288F"/> 28800bit/sec
	<input type="text" value="384F"/> 38400bit/sec
	<input type="text" value="576F"/> 57600bit/sec
<i>Formato</i>	8, N, 1 (8bit, no parità, 1 stop)
<i>Funzioni supportate</i>	WORD READING (max 20 word) (0x03, 0x04) SINGLE WORD WRITING (0x06) MULTIPLE WORDS WRITING (max 20 word) (0x10)

Si riporta di seguito l'elenco di tutti gli indirizzi disponibili, dove:

RO = Read Only
R/W = Read / Write
WO = Write Only

Modbus address	Descrizione	Read Write	Reset value
0	Tipo dispositivo	RO	EEPROM
1	Versione software	RO	EEPROM
5	Address slave	R/W	EEPROM
6	Versione boot	RO	EEPROM
50	Indirizzamento automatico	WO	-
51	Confronto codice impianto	WO	-

500	Caricamento valori di default: 9999 ripristina tutti i valori 9998 ripristina tutti i valori escluso baud-rate e address slave 9997 ripristina tutti i valori escluso address slave 9996 ripristina tutti i valori escluso baud-rate	RW	0
1000	Processo (gradi con decimo per sensori di temperatura; digit per sensori normalizzati)	RO	?
1001	Setpoint1	R/W	EEPROM
1002	Setpoint2	R/W	EEPROM
1003	Setpoint3	R/W	EEPROM
1004	Setpoint4	R/W	EEPROM
1005	Allarme1	R/W	EEPROM
1006	Allarme2	R/W	EEPROM
1007	Setpoint gradiente	RO	EEPROM
1008	Stato uscite (0=off, 1=on) Bit 0 = relè Q1 Bit 1 = relè Q2 Bit 2 = SSR	RO	0
1009	Percentuale uscita caldo (0-10000)	RO	0
1010	Percentuale uscita freddo (0-10000)	RO	0
1011	Stato allarmi (0=assente, 1=presente) Bit0 = Allarme 1 Bit1 = Allarme 2	RO	0
1012	Riarmo manuale: scrivere 0 per riarmare tutti gli allarmi. In lettura (0=non riarmabile, 1=riarmabile): Bit0 = Allarme 1 Bit1 = Allarme 2	WO	0

1013	Flags errori Bit0 = Errore scrittura eeprom Bit1 = Errore lettura eeprom Bit2 = Errore giunto freddo Bit3 = Errore processo (sonda) Bit4 = Errore generico Bit5 = Errore hardware Bit6 = Master off-line Bit7 = Taratura mancante	RO	0
1014	Temperatura giunto freddo (gradi con decimo)	RO	?
1015	Start/Stop 0=regolatore in STOP 1=regolatore in START	R/W	0
1016	Lock conversion ON/OFF 0=Lock conversion off 1=Lock conversion on	R/W	0
1017	Tuning ON/OFF 0=Tuning off 1=Tuning on	R/W	0
1018	Selezione automatico/manuale 0=automatico 1=manuale	R/W	0
1019	Tempo OFF LINE ¹ (millisecondi)	R/W	0
1100	Processo visualizzato (decimale come sul display)	RO	?
1101	Setpoint1 visualizzato (decimale come sul display)	R/W	EEPROM
1102	Setpoint2 visualizzato (decimale come sul display)	R/W	EEPROM
1103	Setpoint3 visualizzato (decimale come sul display)	R/W	EEPROM
1104	Setpoint4 visualizzato (decimale come sul display)	R/W	EEPROM

¹ Se vale 0 il controllo è disabilitato. Se diverso da 0, è "Il tempo massimo che può trascorrere tra due interrogazioni senza che il regolatore si porti in Off-Line". In Off-Line il regolatore va in stato di Stop, disabilita l'uscita di comando, ma mantiene gli allarmi attivi.

1105	Allarme1 visualizzato (decimale come sul display)	R/W	EEPROM
1106	Allarme2 visualizzato (decimale come sul display)	R/W	EEPROM
1107	Setpoint gradiente (decimale come sul display)	RO	EEPROM
1108	Percentuale uscita caldo (0-1000)	RO	0
1109	Percentuale uscita caldo (0-100)	RO	0
1110	Percentuale uscita freddo (0-1000)	RO	0
1111	Percentuale uscita freddo (0-100)	RO	0
2001	Parametro 1	R/W	EEPROM
2002	Parametro 2	R/W	EEPROM
...
2062	Parametro 62	R/W	EEPROM
3000	Disabilitazione controllo macchina da seriale ²	WO	0
3001	Prima word display1 (ascii)	R/W	0
.....	R/W	0
3008	Ottava word display1 (ascii)	R/W	0
3009	Prima word display2 (ascii)	R/W	0
.....	R/W	0
3016	Ottava word display2 (ascii)	R/W	0
3017	Word LED Bit 0 = LED 1 Bit 1 = LED 2 Bit 2 = LED 3 Bit 3 = LED MAN Bit 4 = LED TUN Bit 5 = LED REM	R/W	0
3018	Word tasti (scrivere 1 per assumere il controllo dei tasti) Bit 0 =  Bit 2 =  Bit 1 =  Bit 3 = 	R/W	0

² Scrivendo 1 su questa word, si annullano gli effetti della scrittura su tutti gli indirizzi Modbus da 3001 a 3019. Il controllo ritorna così al regolatore.

3019	Word uscite seriale Bit 0 = relè Q1 Bit 1 = relè Q2 Bit 2 = uscita SSR	R/W	0
3020	Word stato uscite seriale in caso di off-line Bit 0 = relè Q1 Bit 1 = relè Q2 Bit 2 = uscita SSR	R/W	0
3021	Word processo seriale	R/W	0

23.2 Master

Il dispositivo funziona come master se il valore impostato sul parametro 59 **NASE** è diverso da **DIS**.

23.2.1 Modalità master in ritrasmissione

In questa modalità lo strumento scrive il valore da ritrasmettere all'indirizzo impostato sul parametro 60 **Addr**, su altri slave che hanno ID uguale al valore impostato sul parametro 57 **SLAD**. Per la ritrasmissione dei setpoint dopo l'avvenuta scrittura sullo slave, l'ATR142 inizia a leggere la word selezionata: in questo modo un'eventuale variazione del valore sullo slave viene appreso anche dal master. Due interrogazioni successive vengono ritardate del tempo impostato su parametro 57 **SEDE**. Nella seguente tabella sono riportate le selezioni che permettono il funzionamento master in ritrasmissione e la relativa grandezza ritrasmessa

NASE	Descrizione
UPra Write Process	Scrive il valore del processo
RUca Read/Write Command Setpoint	Scrive e legge il valore del setpoint di comando
UouP Write Output Percentage	Scrive la percentuale di uscita calcolata dal P.I.D. (Range 0-10000)
RUAl Read/Write Alarm 1	Scrive e legge il valore del setpoint dell'allarme 1

Il valore letto/scritto può essere riscaldato seguendo la proporzione proposta nella seguente tabella:

NASE	Limiti valore ingresso		Limiti valore riscaldato	
	Min.	Max.	Min.	Max.
UPro Write Process	LoLr Lower Limit Input	uPLr Upper Limit Input	LoLr Lower Limit Retransmission	uPLr Upper Limit Retransmission
rUco Read/Write Command Setpoint	LoLs Lower Limit Setpoint	uPLs Upper Limit Setpoint	LoLr Lower Limit Retransmission	uPLr Upper Limit Retransmission
UoUP Write Output Percentage	0	10000	LoLr Lower Limit Retransmission	uPLr Upper Limit Retransmission
FUA 1 Read/Write Alarm 1 Setpoint	LoLs Lower Limit Setpoint	uPLs Upper Limit Setpoint	LoLr Lower Limit Retransmission	uPLr Upper Limit Retransmission

Il valore in ingresso (compreso tra i limiti minimo e massimo) viene trasformato in maniera lineare nel valore in ritrasmissione compreso tra i valori minimo e massimo in uscita.

La riscaldatura non viene eseguita se i parametri **LoLr** e **uPLr** hanno lo stesso valore.

23.2.2 Modalità master processo remoto















Per abilitare questo funzionamento bisogna impostare **rPro** sul parametro 59 **NASE**. In questa modalità l'ATR142 legge un valore da remoto e lo imposta come processo. Lo slave deve avere un ID uguale a quello impostato sul parametro 57 **SLAd** e la word da leggere è selezionata sul parametro 60 **Addr**. Due interrogazioni successive vengono ritardate del tempo impostato su parametro 57 **SEDE**. Il valore letto può essere riscaldato seguendo la proporzione proposta nella seguente tabella:

NASE	Limiti valore letto		Limiti valore riscaldato	
	Min.	Max.	Min.	Max.
rPro Read Process	LoLr. Lower Limit Retransmission	uPLr. Upper Limit Retransmission	LoL. i Lower Limit Input	uPL. i Upper Limit Input

24 Configurazione

24.1 Modifica parametro di configurazione

Per parametri di configurazione vedi Par. 11.

	Premere	Effetto	Eeguire
1	 per 3 secondi.	Su display 1 compare  con la 1° cifra lampeggiante, mentre sul display 2 compare 	
2	 o 	Si modifica la cifra lampeggiante si passa alla successiva con il tasto 	Inserire la password 
3	 per conferma	Su display 1 compare il primo parametro e sul secondo il valore.	
4	 o 	Scorre i parametri	
5	 +  o 	Si incrementa o decrementa il valore visualizzato premendo prima  e poi un tasto freccia.	Inserire il nuovo dato che verrà salvato al rilascio dei tasti. Per variare un altro parametro tornare al punto 4
6		Fine variazione parametri di configurazione. Il regolatore esce dalla programmazione.	

25 Tabella parametri di configurazione

L'elenco dei parametri sotto riportato è completo; alcuni di questi non appariranno sui modelli che non dispongono delle relative risorse Hardware.

n.	Display	Descrizione parametro	Range di inserimento
1	 Command Output	Selezione tipo uscita di comando	 Default
ATR142-ABC			
	<i>COMANDO</i>	<i>ALLARME 1</i>	<i>ALLARME 2</i>
	Q2	Q1	SSR
	Q1	Q2	SSR
	SSR	Q1	Q2
	Q1(apri) Q2(chiudi)	SSR	-
ATR142-ABC-T			
	<i>COMANDO</i>	<i>ALLARME 1</i>	
	Q1	SSR	
	SSR	Q1	
	Q1(apri) SSR(chiudi)	-	

n.	Display	Descrizione parametro	Range di inserimento
2	<div style="border: 1px solid black; padding: 2px; display: inline-block;">SEn</div> Sensor	Configurazione ingresso analogico	<div style="border: 1px solid black; padding: 2px; display: inline-block;">Ec. F</div> Tc-K -260...1360°C (Default) <div style="border: 1px solid black; padding: 2px; display: inline-block;">Ec. S</div> Tc-S -40...1760°C <div style="border: 1px solid black; padding: 2px; display: inline-block;">Ec. r</div> Tc-R -40...1760°C <div style="border: 1px solid black; padding: 2px; display: inline-block;">Ec. J</div> Tc-J -200...1200°C <div style="border: 1px solid black; padding: 2px; display: inline-block;">PE</div> PT100 -200...600°C <div style="border: 1px solid black; padding: 2px; display: inline-block;">PE I</div> PT100 -200...140°C <div style="border: 1px solid black; padding: 2px; display: inline-block;">n I</div> NI100 -60...180°C <div style="border: 1px solid black; padding: 2px; display: inline-block;">ntc</div> NTC10K -40...125°C <div style="border: 1px solid black; padding: 2px; display: inline-block;">PEc</div> PTC1K -50...150°C <div style="border: 1px solid black; padding: 2px; display: inline-block;">PE5</div> PT500 -100...600°C <div style="border: 1px solid black; padding: 2px; display: inline-block;">PE 1F</div> PT1000 100...600°C <div style="border: 1px solid black; padding: 2px; display: inline-block;">0.10</div> 0...10Volt <div style="border: 1px solid black; padding: 2px; display: inline-block;">0.20</div> 0...20mA <div style="border: 1px solid black; padding: 2px; display: inline-block;">4.20</div> 4...20mA <div style="border: 1px solid black; padding: 2px; display: inline-block;">0.40</div> 0...40mVolt <div style="border: 1px solid black; padding: 2px; display: inline-block;">Pot. 1</div> Potenz.Max 6KΩ F.S. <div style="border: 1px solid black; padding: 2px; display: inline-block;">Pot. 2</div> Potenz.Max 150KΩ F.S.
3	<div style="border: 1px solid black; padding: 2px; display: inline-block;">dP.</div> Decimal Point	Seleziona il tipo di decimale visualizzato	<div style="border: 1px solid black; padding: 2px; display: inline-block;">0</div> Default <div style="border: 1px solid black; padding: 2px; display: inline-block;">00</div> <div style="border: 1px solid black; padding: 2px; display: inline-block;">000</div> <div style="border: 1px solid black; padding: 2px; display: inline-block;">0000</div>
4	<div style="border: 1px solid black; padding: 2px; display: inline-block;">LoL.S</div> Lower Limit Setpoint	Limite inferiore setpoint	-999...+9999 digit* (gradi se temperatura) Default: 0.















* La visualizzazione del punto decimale dipende dall'impostazione del parametro

SEn

 e del parametro

dP.

.

5	 Upper Limit Setpoint	Limite superiore setpoint	-999...+9999 digit* (gradi se temperatura) Default: 1750.
6	 Lower Linear Input	Limite inferiore range An1 solo normalizzati	-999...+9999 digit* Default: 0.
7	 Upper Linear Input	Limite superiore range An1 solo normalizzati	-999...+9999 digit* Default: 1000.
8	 Latch On Function	Impostazione automatica dei limiti per ingressi lineari.	 (Disabled) Default  (Standard)  (Virtual Zero Stored)  (Virtual Zero Initialized)
9	 Offset Calibration	Calibrazione offset Numero che si somma al processo visualizzato (normalmente corregge il valore di temperatura ambiente)	-999...+1000 digit* per sensori normalizzati e potenziometri. -99.9...+100.0 decimi per sensori di temperatura. Default: 0.0.
10	 Gain Calibration	Calibrazione guadagno Valore che si moltiplica al processo per eseguire calibrazioni sul punto di lavoro.	-99.9%...+100.0% Default: 0.0.
11	 Action type	Tipo di regolazione	 : caldo (N.A.) Default  : freddo (N.C.)  :Blocca comando sopra SPV

12	<input type="text" value="C. RE"/> Command Rearmament	Tipo di riarmo del contatto di comando (sempre automatico in funzionamento PID).	<input type="text" value="RE"/> (Automatic Rearmament) Default <input type="text" value="rE"/> (Manual Rearmament) <input type="text" value="rES"/> (Manual Rearmament Stored)
13	<input type="text" value="C. SE"/> Command State Error	Stato del contatto per l'uscita di comando in caso di errore.	<input type="text" value="CA"/> Default <input type="text" value="CC"/>
14	<input type="text" value="C. LD"/> Command Led	Definisce lo stato del led OUT1 in corrispondenza del relativo contatto	<input type="text" value="CA"/> <input type="text" value="CC"/> Default
15	<input type="text" value="C. HY"/> Command Hysteresis	Isteresi in ON/OFF o banda morta in P.I.D.	-999...+999 digit* (decimi di grado se temperatura) Default: 0.0.
16	<input type="text" value="C. DE"/> Command Delay	Ritardo comando (solo in funzionamento ON/OFF). (In caso di servo valvola funziona anche in PID e rappresenta il ritardo tra l'apertura e la chiusura dei due contatti)	-180...+180 secondi (decimi di secondo in caso di servo valvola). Negativo: ritardo in fase di spegnimento. Positivo: ritardo in fase di accensione. Default: 0.

* La visualizzazione del punto decimale dipende dall'impostazione del parametro

e del parametro

17	<input type="text" value="C.SP."/> Command Setpoint Protection	Consente o meno di variare il valore del setpoint di comando	<input type="text" value="FrEE"/> Default <input type="text" value="Loct"/>
18	<input type="text" value="Pb"/> Proportional Band	Banda proporzionale Inerzia del processo in unità (Esempio: se temperatura in °C)	0 on/off se <input type="text" value="E.L."/> uguale a 0 . Default 1-9999 digit* (gradi se temperatura)
19	<input type="text" value="E.I."/> Integral Time	Tempo integrale. Inerzia del processo in secondi	0.0-999.9 secondi (0 integrale disabilitato) Default: 0.
20	<input type="text" value="Ed"/> Derivative Time	Tempo derivativo Normalmente ¼ del tempo integrale	0.0-999.9 secondi (0 derivativo disabilitato) Default: 0.
21	<input type="text" value="Ec"/> Cycle Time	Tempo ciclo (per PID su teleruttore 10/15sec, per PID su SSR 1 sec) o tempo servo (valore dichiarato da produttore del servomotore)	0.1-300.0 secondi Default: 10.0. Per servo-valvole il tempo minimo impostabile è 1.0 secondi.
22	<input type="text" value="oPaL"/> Output Power Limit	Limite del segnale di comando	10-100 % Default: 100.
23	<input type="text" value="AL.1"/> Alarm 1	Selezione allarme 1. L'intervento dell'allarme è associato a	<input type="text" value="d IS"/> (Disabled) Default <input type="text" value="A. AL."/> (Absolute Alarm) <input type="text" value="b. AL."/> (Band Alarm)

		AL1.	<p>HdAL (High Deviation Alarm)</p> <p>LdAL (Low Deviation Alarm)</p> <p>AcAL (Absolute Command setpoint Alarm)</p> <p>StAL (Start Alarm) Attivo in Run</p> <p>COOL (Cooling)</p> <p>E. 1SA (Timer 1 Start Alarm)</p> <p>E. 1EA (Timer 1 End Alarm)</p> <p>E2SA (Timer 2 Start Alarm)</p> <p>E2EA (Timer 2 End Alarm)</p> <p>E. 12S (Timer 1-2 Start Alarm)</p> <p>E. 12E (Timer 1-2 End Alarm)</p>
24	A. 1So Alarm 1 State Output	Contatto uscita allarme 1 e tipo intervento	<p>no S (n.o. start) Default Normalmente aperto attivo allo start</p> <p>nc. S (n.c. start) Normalmente chiuso attivo allo start</p> <p>no t (n.o. threshold) Normalmente aperto attivo al raggiungimento dell'allarme⁹</p> <p>nc. t (n.c. threshold) Normalmente chiuso attivo al raggiungimento dell'allarme⁴</p>
25	A. 1rE Alarm 1 Rearmament	Tipo di riarmo del contatto dell'allarme 1.	<p>A-rE (Automatic Rearmament) Default</p> <p>M-rE (Manual Rearmament)</p> <p>M-rES (Manual Rearmament Stored)</p>

⁹ All'accensione, l'uscita è inibita se lo strumento è in condizione di allarme. Si attiva solo quando rientrato dalla condizione d'allarme, questa si ripresenta.

26	<input type="text" value="A. ISE"/> Alarm 1 State Error	Stato del contatto per l'uscita di allarme 1 in caso di errore.	<input type="text" value="CO"/> Default <input type="text" value="CC"/>
27	<input type="text" value="A. LD"/> Alarm 1 Led	Definisce lo stato del led OUT2 in corrispondenza del relativo contatto	<input type="text" value="CO"/> <input type="text" value="CC"/> Default
28	<input type="text" value="A. IHY"/> Alarm 1 Hysteresis	Isteresi allarme 1	-999...+999 digit* (decimi di grado se temperatura). Default: 0.
29	<input type="text" value="A. IDE"/> Alarm 1 Delay	Ritardo allarme 1	-180...+180 Secondi Negativo: ritardo in fase di uscita dall'allarme. Positivo: ritardo in fase di entrata dell'allarme. Default: 0.
30	<input type="text" value="A. ISP"/> Alarm 1 Setpoint Protection	Protezione set allarme 1. Non consente all'utente di variare il setpoint.	<input type="text" value="FrEE"/> Default <input type="text" value="Loct"/> <input type="text" value="H IDE"/>
31	<input type="text" value="AL. 2"/> Alarm 2	Selezione allarme 2. L'intervento dell'allarme è associato a AL2.	<input type="text" value="d IS"/> (Disabled) Default <input type="text" value="A. AL"/> (Absolute Alarm) <input type="text" value="b. AL"/> (Band Alarm) <input type="text" value="HdAL"/> (High Deviation Alarm) <input type="text" value="LdAL"/> (Low Deviation Alarm) <input type="text" value="AcAL"/> (Absolute Command setpoint Alarm) <input type="text" value="StAL"/> (Start Alarm) <input type="text" value="cool"/> (Cooling)

* La visualizzazione del punto decimale dipende dall'impostazione del parametro

e del parametro

			<input type="checkbox"/> E.1SA (Timer 1 Start Alarm) <input type="checkbox"/> E.1EA (Timer 1 End Alarm) <input type="checkbox"/> E2SA (Timer 2 Start Alarm) <input type="checkbox"/> E2EA (Timer 2 End Alarm) <input type="checkbox"/> E.12S (Timer 1-2 Start Alarm) <input type="checkbox"/> E.12E (Timer 1-2 End Alarm)
32	<input type="checkbox"/> A2S _a Alarm 2 State Output	Contatto uscita allarme 2 e tipo intervento	<input type="checkbox"/> n.o. S (n.o. start) Default Normalmente aperto attivo allo start <input type="checkbox"/> n.c. S (n.c. start) Normalmente chiuso attivo allo start <input type="checkbox"/> n.o. E (n.o. threshold) Normalmente aperto attivo al raggiungimento dell'allarme ¹⁰ <input type="checkbox"/> n.c. E (n.c. threshold) Normalmente chiuso attivo al raggiungimento dell'allarme ⁵
33	<input type="checkbox"/> A2rE Alarm 2 Rearmament	Tipo di riarmo del contatto dell'allarme 2.	<input type="checkbox"/> ArE (Automatic Rearmament) Default <input type="checkbox"/> MrE (Manual Rearmament) <input type="checkbox"/> MrES (Manual Rearmament Stored)
34	<input type="checkbox"/> A2SE Alarm 2 State Error	Stato del contatto per l'uscita di allarme 2 in caso di errore.	<input type="checkbox"/> c.a. Default <input type="checkbox"/> c.c.
35	<input type="checkbox"/> A2L _d Alarm 2 Led	Definisce lo stato del led OUT2 in corrispondenza del relativo contatto	<input type="checkbox"/> c.a. <input type="checkbox"/> c.c. Default















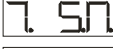

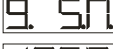
¹⁰ All'accensione, l'uscita è inibita se lo strumento è in condizione di allarme. Si attiva solo quando rientrato dalla condizione d'allarme, questa si ripresenta.

36	A2H4 Alarm 2 Hysteresis	Isteresi allarme 2	-999...+999 digit* (decimi di grado se temperatura). Default: 0.
37	A2DE Alarm 2 Delay	Ritardo allarme 2	-180...+180 Secondi Negativo: ritardo in fase di uscita dall'allarme. Positivo: ritardo in fase di entrata dell'allarme. Default: 0.
38	A2SP Alarm 2 Setpoint Protection	Protezione set allarme 2. Non consente all'operatore di variare il valore impostato.	FrEE Default Loct HiDE
39	COoF Cooling Fluid	Tipo di fluido refrigerante	Air Default oIL H2o
40	PbN Proportional Band Multiplier	Moltiplicatore di banda proporzionale	1.00-5.00 Default: 1.00.
41	oUdB Overlap/Dead Band	Sovrapposizione / Banda Morta	-20.0-50.0% Default: 0.
42	COtC Cooling Cycle Time	Tempo ciclo per uscita refrigerante	1-300 secondi Default: 10.
43	eFLt Conversion Filter	Filtro adc: numero di medie effettuate sulle conversioni analogico-digitali.	d 15 (Disabled) 2. 5N (2 Samples Mean) 3. 5N (3 Samples Mean) 4. 5N (4 Samples Mean) 5. 5N (5 Samples Mean)



* La visualizzazione del punto decimale dipende dall'impostazione del parametro

SEn e del parametro **dP.**

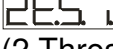
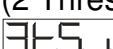
			<input type="checkbox"/> 6. SN (6 Samples Mean) <input type="checkbox"/> 7. SN (7 Samples Mean) <input type="checkbox"/> 8. SN (8 Samples Mean) <input type="checkbox"/> 9. SN (9 Samples Mean) <input type="checkbox"/> 10. SN (10 Samples Mean) Default <input type="checkbox"/> 11. SN (11 Samples Mean) <input type="checkbox"/> 12. SN (12 Samples Mean) <input type="checkbox"/> 13. SN (13 Samples Mean) <input type="checkbox"/> 14. SN (14 Samples Mean) <input type="checkbox"/> 15. SN (15 Samples Mean)
44	<input type="checkbox"/> CFrn Conversion Frequency	Frequenza di campionamento del convertitore analogico-digitali.	<input type="checkbox"/> 242H (242 Hz) <input type="checkbox"/> 123H (123 Hz) <input type="checkbox"/> 62 H (62 Hz) <input type="checkbox"/> 50 H (50 Hz) <input type="checkbox"/> 39 H (39 Hz) <input type="checkbox"/> 33.2H (33.2 Hz) <input type="checkbox"/> 19.6H (19.6 Hz) <input type="checkbox"/> 16.7H (16.7 Hz) Default <input type="checkbox"/> 12.5H (12.5 Hz) <input type="checkbox"/> 10 H (10 Hz) <input type="checkbox"/> 8.33H (8.33 Hz) <input type="checkbox"/> 6.25H (6.25 Hz) <input type="checkbox"/> 4.17H (4.17 Hz)
45	<input type="checkbox"/> FLTE Visualization Filter	Filtro in visualizzazione	<input type="checkbox"/> d. S. (Disabled) Default <input type="checkbox"/> PteCH (Pitchfork filter) <input type="checkbox"/> F. 1or. (First Order) <input type="checkbox"/> F. 1or. P. (First Order with Pitchfork) <input type="checkbox"/> 2. SN (2 Samples Mean)

			 (3 Samples Mean)  (4 Samples Mean)  (5 Samples Mean)  (6 Samples Mean)  (7 Samples Mean)  (8 Samples Mean)  (9 Samples Mean)  (10 Samples Mean)
46	 Tune	Selezione tipo autotuning.	 (Disabled) Default  (Automatic) Calcolo parametri PID all'accensione e al variare del set  (Manual) Lanciato dai tasti o da ingresso digitale.
47	 Setpoint Deviation Tune	Selezione la deviazione dal setpoint di comando, per la soglia usata dall' autotuning, per il calcolo dei parametri PID.	0-5000 digit* (decimi di grado se temperatura). Default: 10.
48	 Operative Mode	Selezione funzionamento	 (Controller) Default  (Programmed Cycle)  (2 Thresholds Switch)  (2 Thresholds Switch Impulsive)  (3 Thresholds Switch Impulsive)

* La visualizzazione del punto decimale dipende dall'impostazione del parametro

 e del parametro .

			4E.S. ↓ (4 Thresholds Switch Impulsive)
49	AUNA Automatic / Manual	Abilita la selezione automatico/ma nuale.	d i S. (Disabled) Default En. (Enabled) En.St. (Enabled Stored)
50	dCt. ↓ Digital Input	Funzionamento ingresso digitale (selezione P48 deve essere cont. oppure PrCY)	d i S. (Disabled) Default: 0. St.St. (Start/Stop) rno. (Run n.o.) rnc. (Run n.c.) Lno. (Lock Conversion n.o.) Lnc. (Lock Conversion n.c.) TunE (Tune) Manuale ANAL ↓ (Automatic Manual impulse) ANAL ↓ (Automatic Manual Contact)
51	GrAd Gradient	Gradiente di salita per Soft Start o ciclo preprogrammato	0 disabilitato 1-9999 Digit/ora* (gradi/ora con visualizzazione del decimo se temperatura) Default: 0.
52	MAE ↓ Maintenance Time	Tempo mantenimento per ciclo preprogrammato	00.00-24.00 hh.mm Default: 00.00.
53	uNc.P. User Menù Cycle Programmed	Permette di modificare gradiente di salita e tempo di mantenimento dal menù	d i S. (Disabled) Default rGr. (Rising Gradient) MAE ↓ (Maintenance Time) rGNE. (Rising Gradient and Maintenance Time) FAGr. (Falling Gradient)

* La visualizzazione del punto decimale dipende dall'impostazione del parametro

SEn. e del parametro dP.

		utente in funzionamento ciclo preprogrammato	<input type="checkbox"/> RFG (Rising and Falling Gradient) <input type="checkbox"/> FGM (Falling Gradient and Maintenance Time) <input type="checkbox"/> ALL (All)
54	<input type="checkbox"/> U1Y Visualization Type	Imposta la visualizzazione sul display 1 e 2.	<input type="checkbox"/> P2S (1 Process, 2 Setpoint) Default <input type="checkbox"/> P2H (1 Process, 2 Hide dopo 3 sec.) <input type="checkbox"/> S2P (1 Setpoint, 2 Process) <input type="checkbox"/> S2H (1 Setpoint, 2 Hide dopo 3 sec.)
55	<input type="checkbox"/> DEG Degree	Selezione tipo gradi	<input type="checkbox"/> C :gradi centigradi (Default) <input type="checkbox"/> F :gradi Fahrenheit
56	<input type="checkbox"/> BDRT Baud Rate	Seleziona il baud rate per la comunicazione seriale	<input type="checkbox"/> 48 F <input type="checkbox"/> 96 F <input type="checkbox"/> 192 F Default <input type="checkbox"/> 288 F <input type="checkbox"/> 384 F <input type="checkbox"/> 576 F
57	<input type="checkbox"/> SLAD Slave Address	Seleziona l'ID dello slave per la comunicazione seriale	0 – 255 Default: 254.
58	<input type="checkbox"/> SEDE Serial Delay	Seleziona il ritardo seriale	0 – 100 millisecondi Default: 20.
59	<input type="checkbox"/> MAST Master	Seleziona la modalità master.	<input type="checkbox"/> DIS (Disable) Default <input type="checkbox"/> WPRO (Write Process) <input type="checkbox"/> RWCO (Read Write Command Setpoint) <input type="checkbox"/> WOPP (Write Output Percentage)

			RWA1 (Read Write Alarm 1 Setpoint) rPrO (Read Process)
60	Addr. Address Retransmission	Seleziona l'indirizzo per la ritrasmissione	0x0000 – 0xFFFF (esadecimale) Default: 0x03E9.
61	LoLr. Lower Limit Retransmission	Limite inferiore range ritrasmissione	-999 – 9999 digit* (gradi se temperatura) Default: 0.
62	uPLr. Upper Limit Retransmission	Limite superiore range ritrasmissione ¹¹	-999 – 9999 digit* (gradi se temperatura) Default: 0.
63	ENrF. Timer Function ¹²	Abilita 1 o 2 timer impostabili da menù utente e collegabili agli allarmi	d i S. (Disable) Default SEnS. (Single Timer Seconds) dE nS. (Double Timer Seconds) SEnM. (Single Timer Minutes) dE nM. (Double Timer Minutes)
64	FAGr. Falling Gradient ¹²	Gradiente di discesa per ciclo preprogrammato	0 disabilitato (raffreddamento naturale) 1-9999 gradi/ora con visualizzazione del decimo Default: 0.

* La visualizzazione del punto decimale dipende dall'impostazione del parametro **SEn.** e del parametro **dP.**.

¹¹ Se il parametro 61 **LoLr.** e il 62 **uPLr.** hanno lo stesso valore il valore ritraspresso non viene rescalato.

¹² Funzione disponibile solo su specifica richiesta.

26 Modi d'intervento allarme

Allarme assoluto o allarme di soglia (selezione **R. AL**)

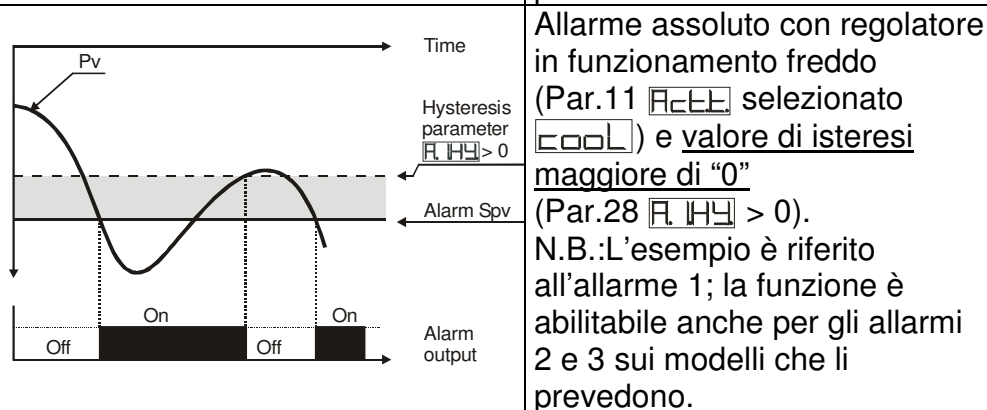
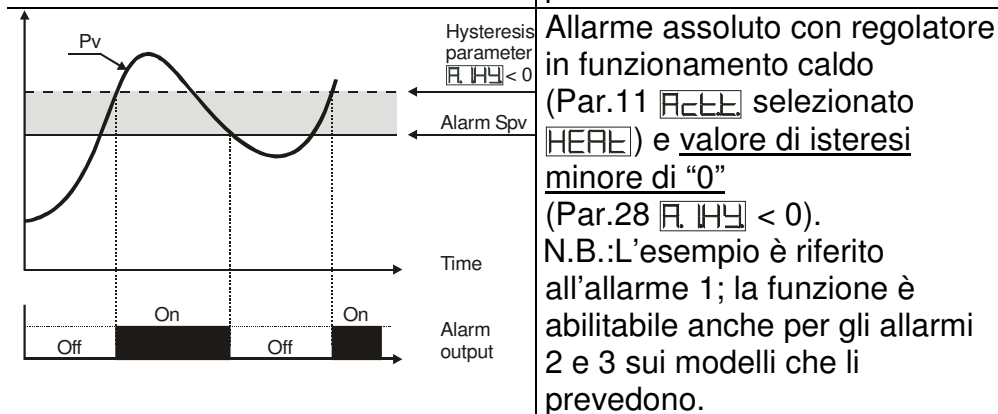
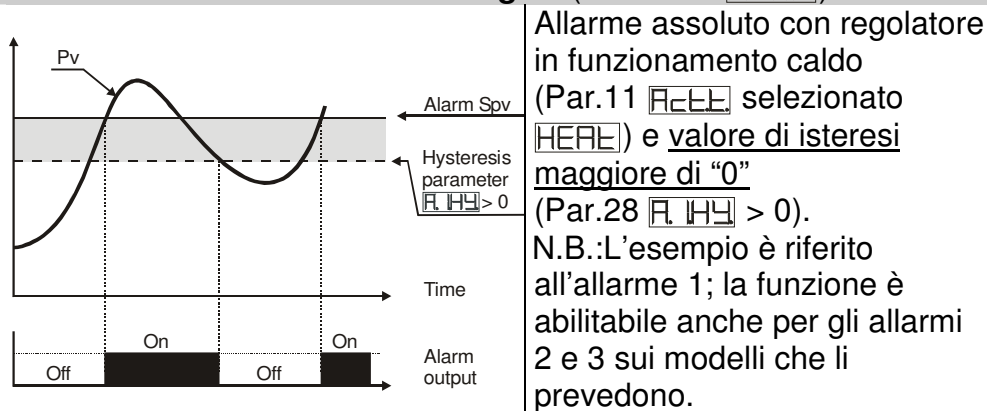

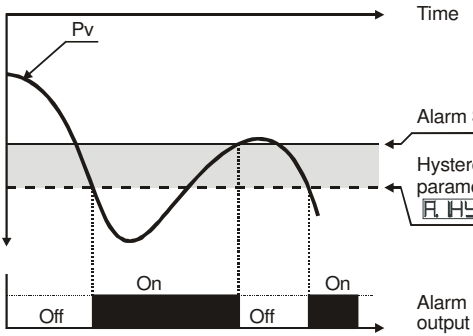

Allarme assoluto con regolatore in funzionamento freddo (Par.11 **A.C.E.E.** selezionato **COOL**) e valore di isteresi minore di "0" (Par.28 **A.HY** < 0).
 N.B.:L'esempio è riferito all'allarme 1; la funzione è abilitabile anche per gli allarmi 2 e 3 sui modelli che li prevedono.

Allarme assoluto o allarme di soglia riferito al setpoint di comando (selezione **A.C.A.L.**)

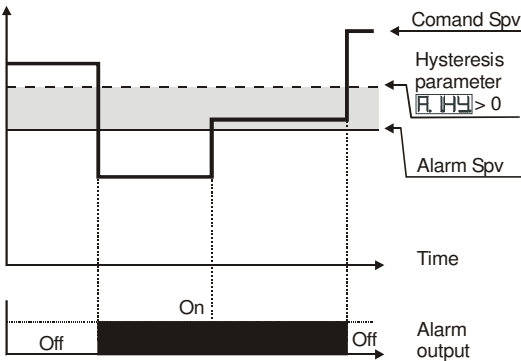

Allarme assoluto riferito al set di comando, con regolatore in funzionamento caldo (Par.11 **A.C.E.E.** selezionato **HEAT**) e valore di isteresi maggiore di "0" (Par.28 **A.HY** > 0).
 Il set di comando può essere variato con la pressione dei tasti freccia da frontale o con comandi su porta seriale RS485.
 N.B.:L'esempio è riferito all'allarme 1; la funzione è abilitabile anche per gli allarmi 2 e 3 sui modelli che li prevedono.

Allarme di Banda (selezione $\boxed{E. AL}$)

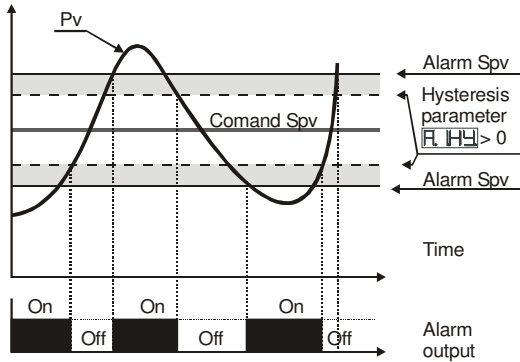

Allarme di banda valore di isteresi maggiore di "0" (Par.28 $\boxed{E. IH4} > 0$).

N.B.:L'esempio è riferito all'allarme 1; la funzione è abilitabile anche per gli allarmi 2 e 3 sui modelli che li prevedono.

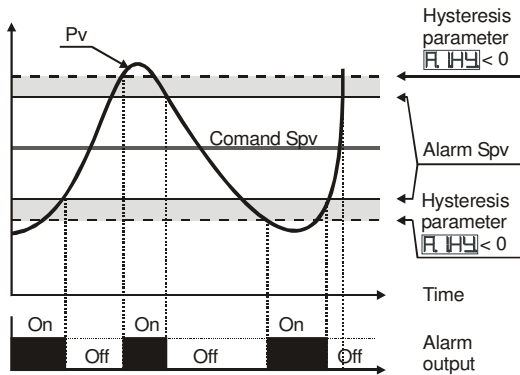

Allarme di banda valore di isteresi minore di "0" (Par.28 $\boxed{E. IH4} < 0$).

N.B.:L'esempio è riferito all'allarme 1; la funzione è abilitabile anche per gli allarmi 2 e 3 sui modelli che li prevedono.

Allarme deviazione superiore (selezione $\overline{H2AL}$)

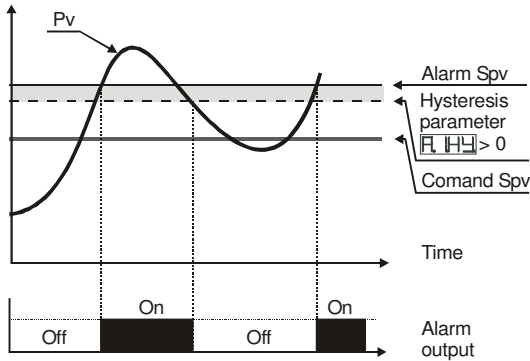

Allarme di deviazione superiore valore di setpoint allarme maggiore di "0" e valore di isteresi maggiore di "0" (Par.28 $\overline{H2AL} > 0$).

N.B.:

a) L'esempio è riferito all'allarme 1; la funzione è abilitabile anche per gli allarmi 2 e 3 sui modelli che li prevedono.

b) Con isteresi minore di "0" ($\overline{H2AL} < 0$) la linea tratteggiata si sposta sopra il Setpoint di allarme.

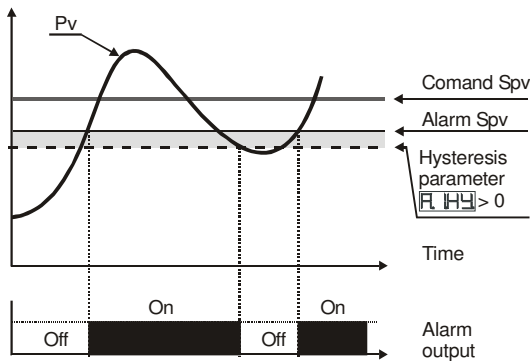

Allarme di deviazione superiore valore di setpoint allarme minore di "0" e valore di isteresi maggiore di "0" (Par.28 $\overline{H2AL} > 0$).

N.B.:

a) L'esempio è riferito all'allarme 1; la funzione è abilitabile anche per gli allarmi 2 e 3 sui modelli che li prevedono.

b) Con isteresi minore di "0" ($\overline{H2AL} < 0$) la linea tratteggiata si sposta sopra il Setpoint di allarme.

Allarme deviazione inferiore (selezione \overline{HARL})

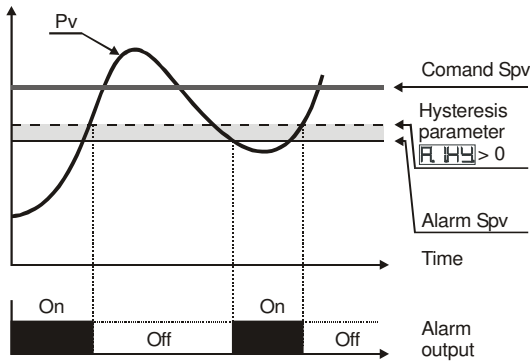

Allarme di deviazione inferiore valore di setpoint allarme maggiore di "0" e valore di isteresi maggiore di "0" (Par.28 $\overline{HARL} > 0$).

N.B.:

a) L'esempio è riferito all'allarme 1; la funzione è abilitabile anche per gli allarmi 2 e 3 sui modelli che li prevedono.

b) Con isteresi minore di "0" ($\overline{HARL} < 0$) la linea tratteggiata si sposta sotto il Setpoint di allarme.

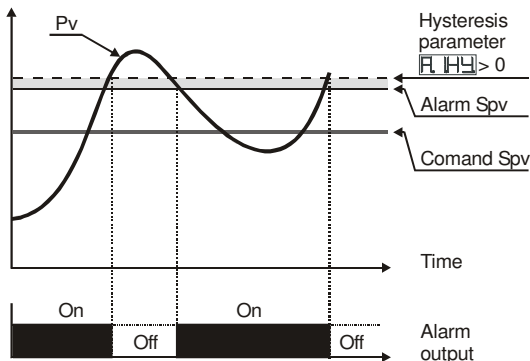

Allarme di deviazione inferiore valore di setpoint allarme minore di "0" e valore di isteresi maggiore di "0" (Par.28 $\overline{HARL} > 0$).

N.B.:

a) L'esempio è riferito all'allarme 1; la funzione è abilitabile anche per gli allarmi 2 e 3 sui modelli che li prevedono.

b) Con isteresi minore di "0" ($\overline{HARL} < 0$) la linea tratteggiata si sposta sotto il Setpoint di allarme.

27 Tabella segnalazioni anomalie

In caso di mal funzionamento dell'impianto il controllore spegne l'uscita di regolazione e segnala il tipo di anomalia riscontrata. Per esempio il regolatore segnalerà la rottura di un'eventuale termocoppia collegata visualizzando **E-05** (lampeggiante) sul display. Per le altre segnalazioni vedi la tabella sottostante.

#	Causa	Cosa Fare
E-01	Errore in programmazione cella E ² PROM.	Chiamare Assistenza
E-02	Guasto sensore temperatura giunto freddo o temperatura ambiente al di fuori dei limiti ammessi.	Chiamare Assistenza
E-04	Dati di configurazione errati. Possibile perdita della tarature dello strumento.	Verificare che i parametri di configurazione siano corretti.
E-05	Termocoppia aperta o temperatura fuori limite.	Controllare il collegamento con le sonde e la loro integrità.
E-06	Fuori linea in caso di funzionamento master con processo remoto	Controllare il collegamento seriale, il baud-rate e l'ID dei moduli
E-08	Taratura mancante	Chiamare Assistenza

28 Promemoria configurazione

Data:	Modello ATR142:
Installatore:	Impianto:
Note:	

cout	Selezione tipo uscita di comando	
SEn	Configurazione ingresso analogico	
dP.	Seleziona il tipo di decimale visualizzato	
LoLS	Limite inferiore setpoint	
uPLS	Limite superiore setpoint	
LoL₁	Limite inferiore range An1 solo per normalizzati	
uPL₁	Limite superiore range An1 solo per normalizzati	
LA_{cc}	Impostazione automatica dei limiti per ingressi lineari.	
ocAL	Calibrazione offset	
GcAL	Calibrazione guadagno	
AcEtE	Tipo di regolazione	
c. rE	Tipo di riarmo del contatto di comando	
c. SE	Stato del contatto per l'uscita di comando in caso di errore.	
c. Ld	Definisce lo stato del led OUT1	
c. HY	Isteresi in ON/OFF o banda morta in P.I.D.	
c. dE	Ritardo comando	
c. SP	Protezione del setpoint di comando	
Pb	Banda proporzionale	
t_i	Tempo integrale	
t_d	Tempo derivativo	
t_c	Tempo ciclo	
oPoL	Limite del segnale di comando	
AL₁	Selezione allarme 1	
A₁So	Contatto uscita allarme 1 e tipo intervento	
A₁rE	Tipo di riarmo del contatto dell'allarme 1.	
A₁SE	Stato del contatto per l'uscita di allarme 1	
A₁Ld	Stato del led OUT2	

A. IH4	Isteresi allarme 1	
A. IAE	Ritardo allarme 1	
A. ISP	Protezione set allarme 1	
AL. 2	Selezione allarme 2	
A2Sa	Contatto uscita allarme 2 e tipo intervento	
A2rE	Tipo di riarmo del contatto dell'allarme 2	
A2SE	Stato del contatto per l'uscita di allarme 2	
A2Ld	Stato del led OUT2	
A2H4	Isteresi allarme 2	
A2dE	Ritardo allarme 2	
A2SP	Protezione set allarme 2	
cooF	Tipo di fluido refrigerante	
PbN	Moltiplicatore di banda proporzionale	
owdb	Sovrapposizione / Banda Morta	
coctc	Tempo ciclo per uscita refrigerante	
cFLE	Filtro convertitore analogico	
cFcr	Frequenza di campionamento del convertitore analogico	
uFLE	Filtro in visualizzazione	
tunE	Selezione tipo autotuning	
Sdtu	Deviazione dal setpoint di comando, per la soglia tuning	
oPNa	Selezione funzionamento	
AuNA	Selezione automatico/manuale	
dGE. u	Funzionamento ingresso digitale	
GrAd	Gradiente di salita per Soft Start	
NAE. u	Tempo mantenimento per ciclo	
uNcP	Modificare gradiente e tempo di mantenimento da utente	
u t4	Selezione visualizzazione sui display	
dEGr	Selezione tipo gradi	
bdrE	Seleziona il baud rate per la comunicazione seriale	
SLAd	Seleziona l'indirizzo dello slave	

PIXSYS

Via Tagliamento, 18
30030 Mellaredo di Pianiga (VE)

www.pixsys.net

e-mail: sales@pixsys.net - support@pixsys.net

Software Rev. 1.06

2300.10.092-RevD 040309

2300.10.092-D