

OS-E1UF-U 16 / M16

Ex d cable gland, brass nickel-plated, M16

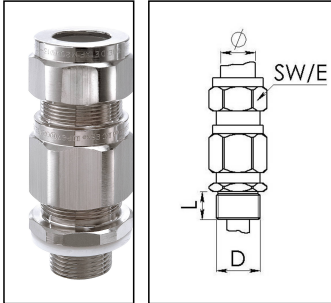

Products may differ in size, colour and appearance to those shown. If you require further information or customisation, please contact us directly.



Material cable gland	Brass nickel-plated
Material sealing gasket	Silicone
Temp. range min	-60 °C
Temp. range max	110 °C
Protection class	IP66 / IP67
Type of protection	Ex eb, Ex tb, Ex db
Ex-Certificate	IECEX, ATEX
Thread type	M
Ø Connection thread D	16
Lead	1,5
Length screw-in thread L	15 mm
Ø cable diameter min	7 mm
Ø cable diameter max	16,1 mm
Ø cable below cable shield	5 mm - 11,5 mm
Key width SW	25 mm
Collar diameter (E)	27 mm
Total length TL	67 mm
Surface	Nickel-plated
Order no. nickel-plated	50107579
Type	OS-E1UF-U 16 / M16
Packing unit	1
ETIM-Classification	EC000441

17.07.2020

Your Contact:

WISKA Hoppmann GmbH

Kisdorfer Weg 28 · 24568 Kaltenkirchen · Germany

☎ +49-4191-508-0 · 📠 +49-4191-508-209

contact@wiska.de · www.wiska.com

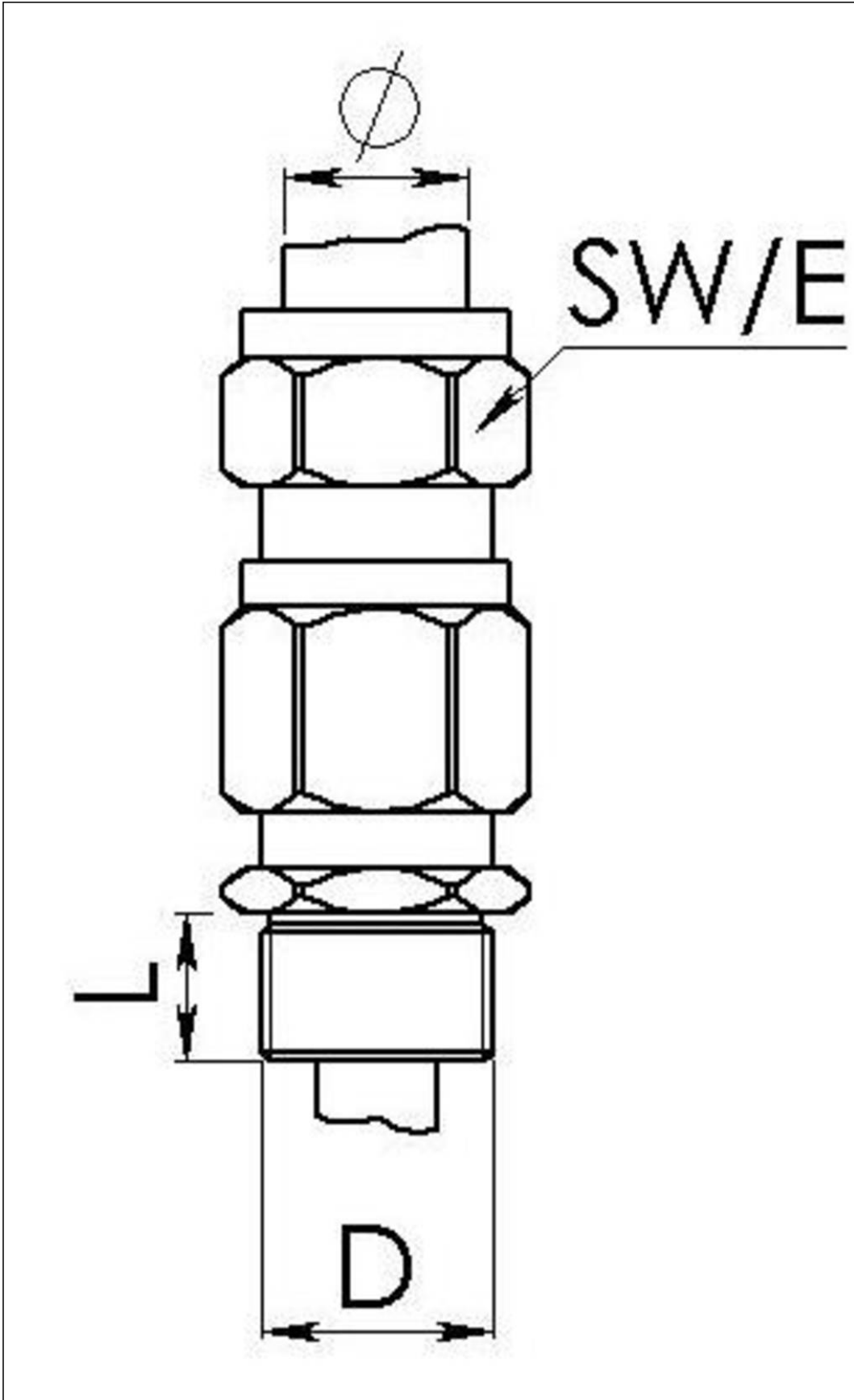

Your Contact:
WISKA Hoppmann GmbH
Kisdorfer Weg 28 · 24568 Kaltenkirchen · Germany
☎ +49-4191-508-0 · 📠 +49-4191-508-209
contact@wiska.de · www.wiska.com