

OS-A2F-U 75 / M75

Ex d cable gland, brass nickel-plated, M75

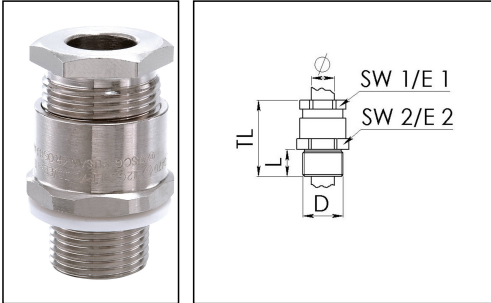

Products may differ in size, colour and appearance to those shown. If you require further information or customisation, please contact us directly.



Material cable gland	Brass nickel-plated
Material sealing gasket	Silicone
Temp. range min	-60 °C
Temp. range max	110 °C
Protection class	IP66 / IP67
Type of protection	Ex tb, Ex eb, Ex db
Ex-Certificate	IECEx, ATEX
Thread type	M
Ø Connection thread D	75
Lead	1,5
Length screw-in thread L	20 mm
Ø cable diameter min	54 mm
Ø cable diameter max	61 mm
Key width SW	85 mm
Key width SW1	78 mm
Key width SW2	85 mm
Collar diameter E1	88 mm
Collar diameter E2	90 mm
Total length TL	78 mm
Surface	Nickel-plated
Order no. nickel-plated	50107577
Type	OS-A2F-U 75 / M75
Packing unit	1
ETIM-Classification	EC000441

Your Contact:

WISKA Hoppmann GmbH

Kisdorfer Weg 28 · 24568 Kaltenkirchen · Germany

☎ +49-4191-508-0 · 📠 +49-4191-508-209

contact@wiska.de · www.wiska.com

15.07.2020

Your Contact:

WISKA Hoppmann GmbH

Kisdorfer Weg 28 · 24568 Kaltenkirchen · Germany

☎ +49-4191-508-0 · 📠 +49-4191-508-209

contact@wiska.de · www.wiska.com

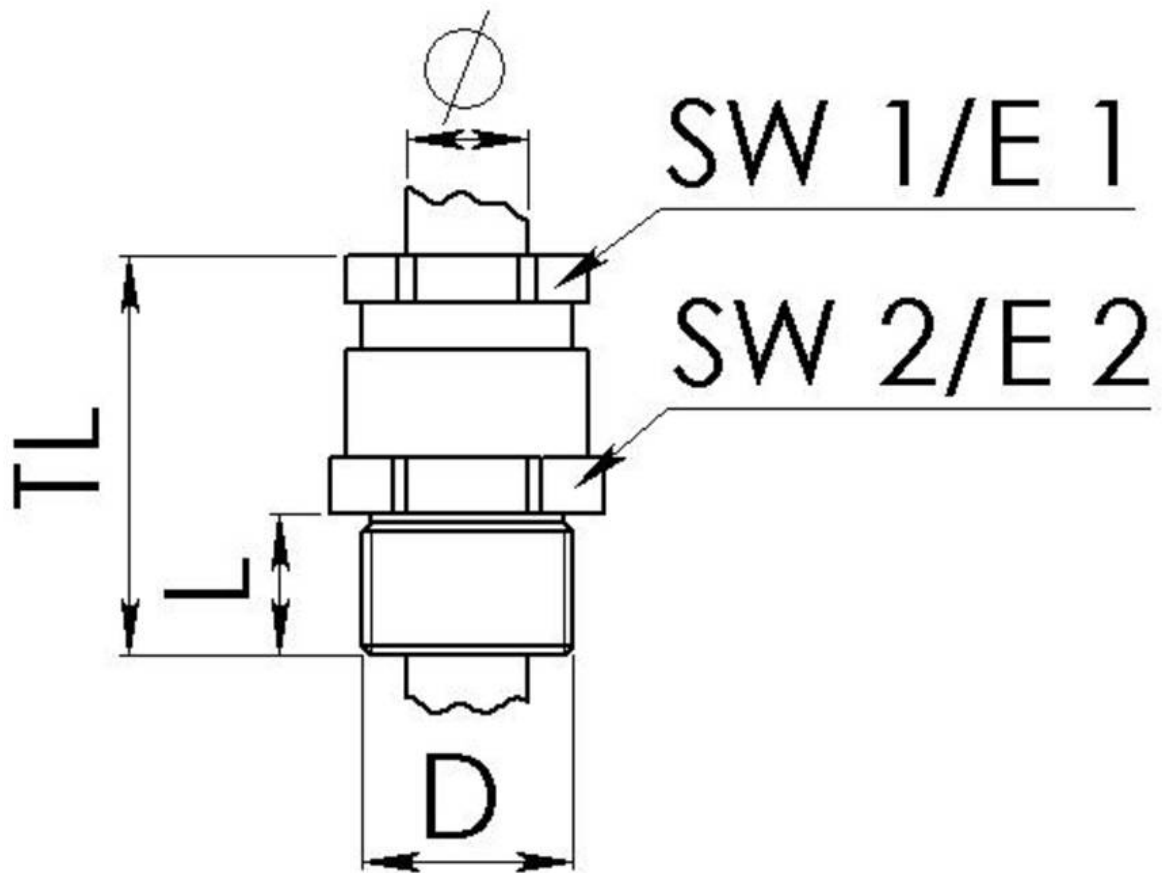

Your Contact:

WISKA Hoppmann GmbH

Kisdorfer Weg 28 · 24568 Kaltenkirchen · Germany

☎ +49-4191-508-0 · 📠 +49-4191-508-209

contact@wiska.de · www.wiska.com