

## OS-A2F-U 50 / M50

Ex d cable gland, brass nickel-plated, M50

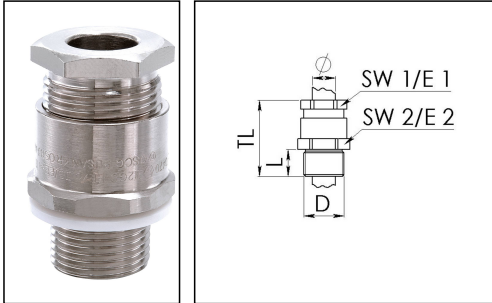

Products may differ in size, colour and appearance to those shown. If you require further information or customisation, please contact us directly.



Material cable gland	Brass nickel-plated
Material sealing gasket	Silicone
Temp. range min	-60 °C
Temp. range max	110 °C
Protection class	IP66 / IP67
Type of protection	Ex eb, Ex tb, Ex db
Ex-Certificate	IECEx, ATEX
Thread type	M
Ø Connection thread D	50
Lead	1,5
Length screw-in thread L	15 mm
Ø cable diameter min	30 mm
Ø cable diameter max	42 mm
Key width SW	58 mm
Key width SW1	53 mm
Key width SW2	58 mm
Collar diameter E1	61 mm
Collar diameter E2	62 mm
Total length TL	62 mm
Surface	Nickel-plated
Order no. nickel-plated	50107574
Type	OS-A2F-U 50 / M50
Packing unit	1
ETIM-Classification	EC000441

Your Contact:

WISKA Hoppmann GmbH

Kisdorfer Weg 28 · 24568 Kaltenkirchen · Germany

☎ +49-4191-508-0 · 📠 +49-4191-508-209

contact@wiska.de · www.wiska.com

15.07.2020

Your Contact:

**WISKA Hoppmann GmbH**

Kisdorfer Weg 28 · 24568 Kaltenkirchen · Germany

☎ +49-4191-508-0 · 📠 +49-4191-508-209

contact@wiska.de · www.wiska.com

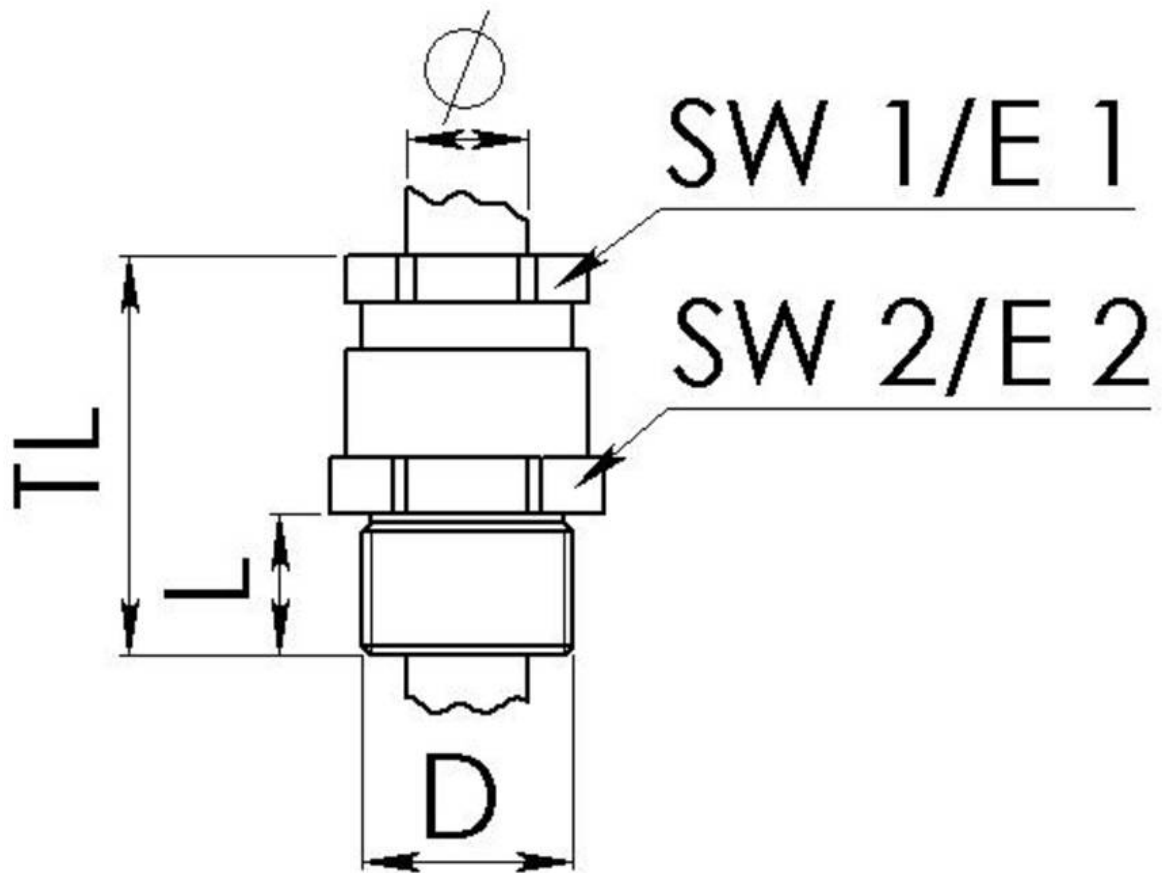

Your Contact:

**WISKA Hoppmann GmbH**

Kisdorfer Weg 28 · 24568 Kaltenkirchen · Germany

☎ +49-4191-508-0 · 📠 +49-4191-508-209

contact@wiska.de · www.wiska.com