

EMSKE-L 50 LT

Ex-cable gland LowTemp, brass nickel-plated with long thread, M50

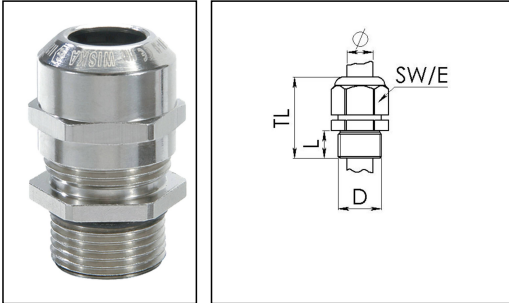

Products may differ in size, colour and appearance to those shown. If you require further information or customisation, please contact us directly.



Material cable gland	Brass nickel-plated
Material clamping cage	Polyamide
Material sealing gasket	Silicone
Temp. range min	-60 °C
Temp. range max	75 °C
Protection class	IP66 / IP68 (5 bar 30 min)
Type of protection	Ex eb, Ex tb
Ex-Certificate	ATEX, IECEx
Thread type	M
Ø Connection thread D	50
Lead	1,5
Length screw-in thread L	15 mm
Ø cable diameter min	21 mm
Ø cable diameter max	35 mm
Key width SW	55 mm
Collar diameter (E)	61 mm
Total length TL	57 mm - 68 mm
Install. torques fitting	30 N m
Install. torques cap nut	30 N m
Surface	Nickel-plated
Order no. nickel-plated	10065944
Type	EMSKE-L 50 LT
Packing unit	10
ETIM-Classification	EC000441

Your Contact:

WISKA Hoppmann GmbH

Kisdorfer Weg 28 · 24568 Kaltenkirchen · Germany

☎ +49-4191-508-0 · 📠 +49-4191-508-209

contact@wiska.de · www.wiska.com

Recommended accessories

EMMU 50	10063147
RDE 50 LT	10063966
BS 35	10064017

14.07.2020

Your Contact:

WISKA Hoppmann GmbH

Kisdorfer Weg 28 · 24568 Kaltenkirchen · Germany

☎ +49-4191-508-0 · 📠 +49-4191-508-209

contact@wiska.de · www.wiska.com



Your Contact:

WISKA Hoppmann GmbH

Kisdorfer Weg 28 · 24568 Kaltenkirchen · Germany

☎ +49-4191-508-0 · 📠 +49-4191-508-209

contact@wiska.de · www.wiska.com