

## EMSKE 63

Ex-cable gland, brass nickel-plated with short thread, M63

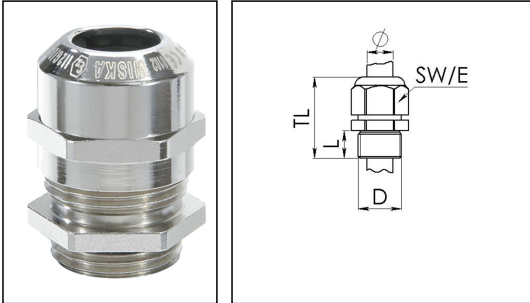

Products may differ in size, colour and appearance to those shown. If you require further information or customisation, please contact us directly.



Material cable gland	Brass nickel-plated
Material clamping cage	Polyamide
Material sealing gasket	EPDM
Temp. range min	-40 °C
Temp. range max	75 °C
Protection class	IP66 / IP68 (5 bar 30 min)
Type of protection	Ex eb, Ex tb
Ex-Certificate	ATEX, IECEx
Thread type	M
Ø Connection thread D	63
Lead	1,5
Length screw-in thread L	10 mm
Ø cable diameter min	34 mm
Ø cable diameter max	48 mm
Ø cable diameter UL	38,1 mm - 47,5 mm
Key width SW	68 mm
Collar diameter (E)	75 mm
Total length TL	56 mm - 67 mm
Install. torques fitting	40 N m
Install. torques cap nut	40 N m
Surface	Nickel-plated
Order no. nickel-plated	10065047
Type	EMSKE 63
Packing unit	10
ETIM-Classification	EC000441

Your Contact:

WISKA Hoppmann GmbH

Kisdorfer Weg 28 · 24568 Kaltenkirchen · Germany

☎ +49-4191-508-0 · 📠 +49-4191-508-209

contact@wiska.de · www.wiska.com

**Recommended accessories**

<b>RDE 63</b>	10062189
<b>EMMU 63</b>	10063148
<b>BS 48</b>	10064019

14.07.2020

Your Contact:

**WISKA Hoppmann GmbH**

Kisdorfer Weg 28 · 24568 Kaltenkirchen · Germany

☎ +49-4191-508-0 · 📠 +49-4191-508-209

contact@wiska.de · www.wiska.com



Your Contact:

**WISKA Hoppmann GmbH**

Kisdorfer Weg 28 · 24568 Kaltenkirchen · Germany

☎ +49-4191-508-0 · 📠 +49-4191-508-209

contact@wiska.de · www.wiska.com