

EMSKE 50

Ex-cable gland, brass nickel-plated with short thread, M50

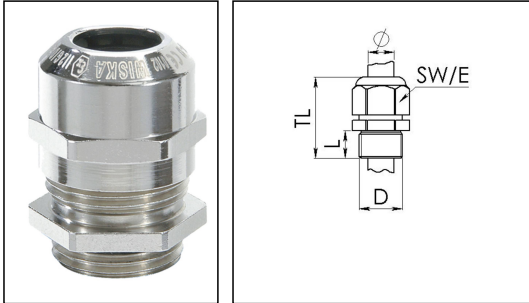

Products may differ in size, colour and appearance to those shown. If you require further information or customisation, please contact us directly.



Material cable gland	Brass nickel-plated
Material clamping cage	Polyamide
Material sealing gasket	EPDM
Temp. range min	-40 °C
Temp. range max	75 °C
Protection class	IP66 / IP68 (5 bar 30 min)
Type of protection	Ex eb, Ex tb
Ex-Certificate	ATEX, IECEx
Thread type	M
Ø Connection thread D	50
Lead	1,5
Length screw-in thread L	9 mm
Ø cable diameter min	21 mm
Ø cable diameter max	35 mm
Ø cable diameter UL	24,3 mm - 33,4 mm
Key width SW	55 mm
Collar diameter (E)	61 mm
Total length TL	51 mm - 62 mm
Install. torques fitting	30 N m
Install. torques cap nut	30 N m
Surface	Nickel-plated
Order no. nickel-plated	10065046
Type	EMSKE 50
Packing unit	10
ETIM-Classification	EC000441

Your Contact:

WISKA Hoppmann GmbH

Kisdorfer Weg 28 · 24568 Kaltenkirchen · Germany

☎ +49-4191-508-0 · 📠 +49-4191-508-209

contact@wiska.de · www.wiska.com

Recommended accessories

RDE 50	10062188
EMMU 50	10063147
BS 35	10064017

14.07.2020

Your Contact:

WISKA Hoppmann GmbH

Kisdorfer Weg 28 · 24568 Kaltenkirchen · Germany

 +49-4191-508-0 ·  +49-4191-508-209

contact@wiska.de · www.wiska.com



Your Contact:

WISKA Hoppmann GmbH

Kisdorfer Weg 28 · 24568 Kaltenkirchen · Germany

☎ +49-4191-508-0 · 📠 +49-4191-508-209

contact@wiska.de · www.wiska.com