

EMSKE 20

Ex-cable gland, brass nickel-plated with short thread, M20

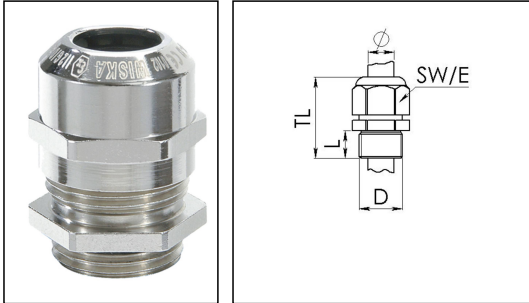

Products may differ in size, colour and appearance to those shown. If you require further information or customisation, please contact us directly.



Material cable gland	Brass nickel-plated
Material clamping cage	Polyamide
Material sealing gasket	EPDM
Temp. range min	-40 °C
Temp. range max	75 °C
Protection class	IP66 / IP68 (5 bar 30 min)
Type of protection	Ex eb, Ex tb
Ex-Certificate	ATEX, IECEx
Thread type	M
Ø Connection thread D	20
Lead	1,5
Length screw-in thread L	6 mm
Ø cable diameter min	6 mm
Ø cable diameter max	13 mm
Ø cable diameter UL	7,5 mm - 11,3 mm
Key width SW	24 mm
Collar diameter (E)	27 mm
Total length TL	29 mm - 37 mm
Install. torques fitting	8 N m
Install. torques cap nut	8 N m
Surface	Nickel-plated
Order no. nickel-plated	10065042
Type	EMSKE 20
Packing unit	50
ETIM-Classification	EC000441

Your Contact:

WISKA Hoppmann GmbH

Kisdorfer Weg 28 · 24568 Kaltenkirchen · Germany

☎ +49-4191-508-0 · 📠 +49-4191-508-209

contact@wiska.de · www.wiska.com

Recommended accessories

RDE 20	10062185
EMMU 20	10063143
BS 13	10064010

14.07.2020

Your Contact:

WISKA Hoppmann GmbH

Kisdorfer Weg 28 · 24568 Kaltenkirchen · Germany

☎ +49-4191-508-0 · 📠 +49-4191-508-209

contact@wiska.de · www.wiska.com



Your Contact:

WISKA Hoppmann GmbH

Kisdorfer Weg 28 · 24568 Kaltenkirchen · Germany

☎ +49-4191-508-0 · 📠 +49-4191-508-209

contact@wiska.de · www.wiska.com