

## OSAJ 20 / M16(M)\*M20(F)

Ex d enlargement adaptor, brass nickel-plated, M16-M20

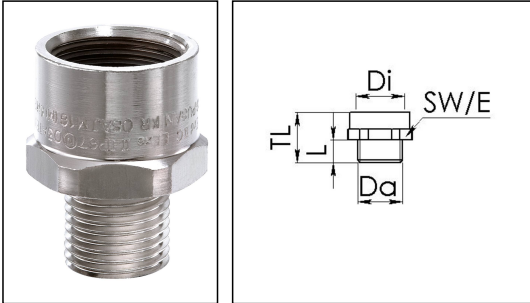

Products may differ in size, colour and appearance to those shown. If you require further information or customisation, please contact us directly.



<b>Material</b>	Brass nickel-plated
<b>Temp. range min</b>	-60 °C
<b>Temp. range max</b>	110 °C
<b>Protection class</b>	IP66 / IP67
<b>Type of protection</b>	Ex eb, Ex db, Ex tb
<b>Ex-Certificate</b>	IECEX, ATEX
<b>Thread type outer</b>	M
<b>Ø outer thread</b>	16
<b>Lead outer</b>	1,5
<b>Length screw-in thread L</b>	15 mm
<b>Thread type inner</b>	M
<b>Ø inner thread</b>	20
<b>Lead inner</b>	1,5
<b>Length internal thread</b>	18 mm
<b>Key width SW</b>	25 mm
<b>Collar diameter (E)</b>	27 mm
<b>Total length TL</b>	36 mm
<b>Surface</b>	Nickel-plated
<b>Order no. nickel-plated</b>	50065686
<b>Type</b>	OSAJ 20 / M16(M)*M20(F)
<b>Packing unit</b>	1
<b>ETIM-Classification</b>	EC000938

09.07.2020

Your Contact:

**WISKA Hoppmann GmbH**

Kisdorfer Weg 28 · 24568 Kaltenkirchen · Germany

☎ +49-4191-508-0 · 📠 +49-4191-508-209

contact@wiska.de · www.wiska.com



Your Contact:

**WISKA Hoppmann GmbH**

Kisdorfer Weg 28 · 24568 Kaltenkirchen · Germany

☎ +49-4191-508-0 · 📠 +49-4191-508-209

contact@wiska.de · www.wiska.com