

The ENSTO logo is displayed in a bold, blue, sans-serif font in the upper right corner of the page.

# Full Covered Conductor Solution

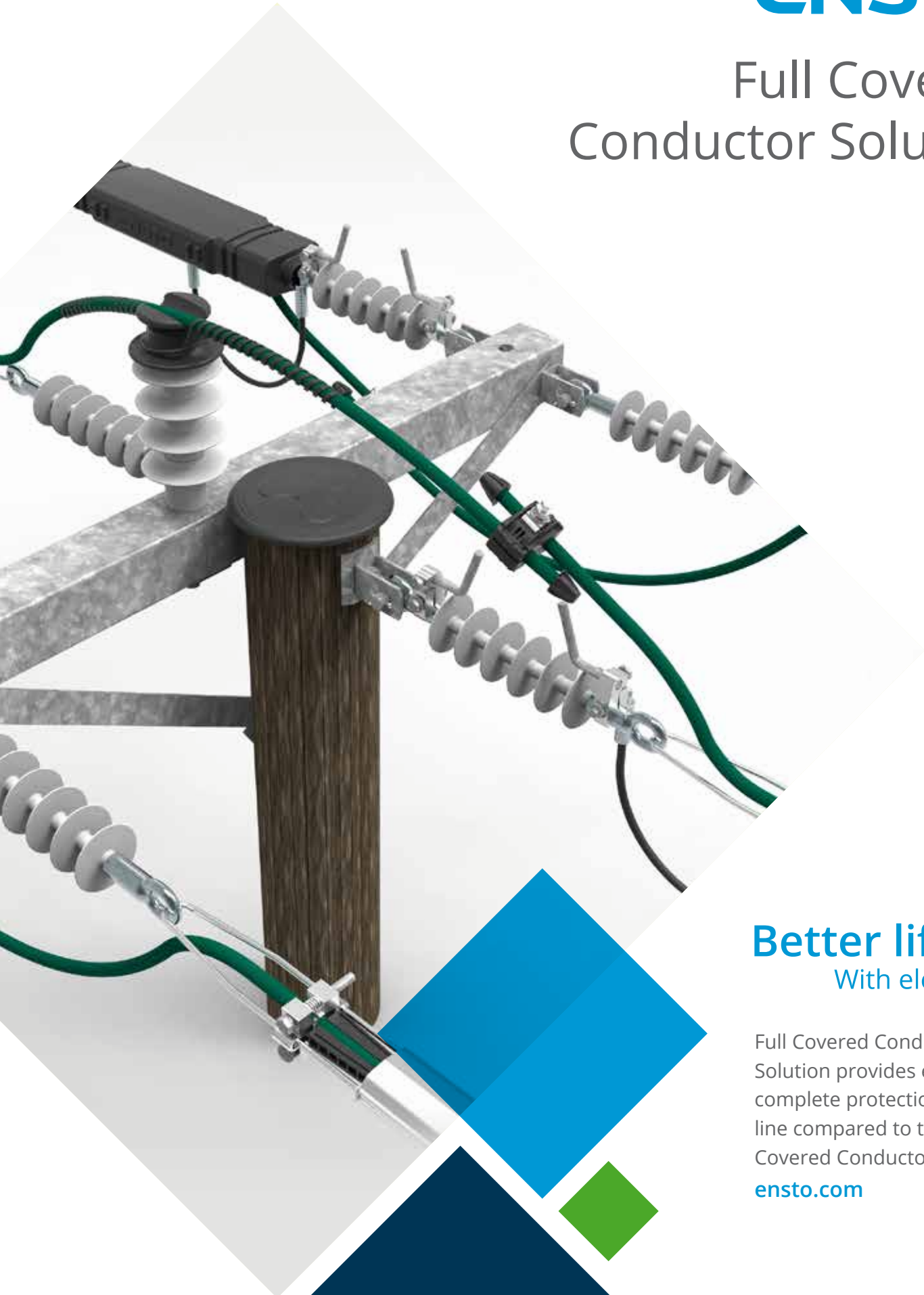

**Better life.**  
With electricity.

Full Covered Conductor Solution provides even more complete protection for the line compared to traditional Covered Conductor Solution  
[ensto.com](http://ensto.com)



# Full Covered Conductor Solution

## Table of Contents

Ensto – Electrical Solution Provider . . . . .	5
Full Covered Conductor Solution . . . . .	6
Power Arc Devices (PAD) . . . . .	8
Current Limiting Devices (CLD) . . . . .	8
Wildlife Protection . . . . .	9
Full Covered Conductor structures . . . . .	10
Suspension structure . . . . .	11
Tension structure . . . . .	13
Angle structure . . . . .	15
Terminal structure 1 . . . . .	16
Terminal structure 2 . . . . .	18
Angle tension structure . . . . .	20
Crossarms – Limits of service . . . . .	22
Regulation tables . . . . .	26
Product information . . . . .	29
CIL10X series . . . . .	33
Overhead Line Solutions . . . . .	34

A high-angle, top-down view of a person with reddish-brown hair, wearing a green jacket and blue jeans, standing on a rooftop balcony. The person is holding a smartphone up to take a picture of a city at night. The balcony has a wooden deck and a glass railing. The city below is illuminated with streetlights and building lights, with cars visible on the roads. A large blue diagonal graphic element is overlaid on the left side of the image.

Ensto's reliability  
has its foundation  
in strong product  
development  
performed in  
cooperation with  
our customers.



# Ensto – Electrical Solution Provider

Ensto is an international family business, which designs and provides smart electrical solutions to improve the safety, functionality, reliability and efficiency of smart grids, buildings and transportation. *We want to create Better life. With electricity.*

Ensto was founded in 1958 and employs ca. 1,600 passionate professionals in Europe, the USA and Asia. In 2016, we generated turnover of ca. 260 million euros. Our business is divided into four business areas: Ensto Electrification, Ensto Lighting, Ensto Solutions and Ensto Utility Networks. We believe in a better life with electricity and a more sustainable tomorrow.

In Ensto Utility Networks we are committed to providing solutions for smarter grids with excellent network power quality. Our proven technologies and unique customer support ensure reliable electricity distribution, which is the basis for Smart Grid. Ensto offers solutions for:

- Low and medium voltage overhead lines
- Low and medium voltage underground cables
- Power quality
- Network automation

## Well-functioning Solutions

Ensto's solutions play a key role in building reliable, low-loss electricity distribution networks with disturbance-free service. High-quality products guarantee lower total costs for creating robust distribution networks.

We have thorough experience and knowledge of distribution networks in even the most demanding conditions: cold, hot, and stormy surroundings all over the world. Our products are developed in close cooperation with our customers. They are designed for a long service life, minimal need for maintenance, and a low life-cycle impact on the environment.

## Tested to Meet Your Expectations

Ensto has fully equipped and calibrated testing laboratories in-house; even an accredited one in our headquarters in Finland. We test our products to ensure meeting the toughest national and international standards – in fact, beyond standard requirements. We work with

many international test laboratories and use well-known external laboratories for certification testing.

## Answers Close to You

Ensto has local sales personnel in 20 countries, allowing us to serve and support our customers flexibly in their own language, thanks to a strong local presence. In addition, we sell throughout the world.

## Unique Training

Ensto's extensive training program Ensto Pro provides continuing support and comprehensive training for our customers. The benefits of this training include time, cost, and energy savings and fewer installation errors. Moreover, we receive reliable input on the solutions the customer truly needs and all training sessions are customized.





Full Covered Conductor  
Solution provides  
even more complete  
protection for the line  
compared to traditional  
Covered Conductor  
Solution.

Covered Conductor line  
under construction.

# Full Covered Conductor Solution

Covered conductors were developed to improve reliability of the distribution of electricity. Time has assured the Covered Conductor solution to be extremely functional and reliable. Faults caused by snow, ice or storms have decreased remarkably. Full Covered Conductor Solution provides even more complete protection for the line.

Covered Conductor Solution (CC) allows space savings e.g. 40% narrower clearances for line corridors through forested areas, compared to a standard bare line. With parallel line structure, the space saving is even bigger. Ensto accessories for medium voltage Covered Conductor Solutions are tested according to the EN 50397-2 standard which, compared to earlier national standards, is substantially more demanding and covers the accessories designed for such solutions more extensively. This brings a whole lot of reliability for the Covered Conductor Solution.

## Benefits of FCCS

Full Covered Conductor Solution (FCC) provides even more complete protection for the line compared to traditional Covered Conductor Solution.

In addition for the covering of the conductors, other live parts of the line have been covered also such as insulators, suspension- and tension clamps, connectors, etc. This has been done to acquire even more protection from wildlife, such as birds and squirrels, and to prevent interruptions in the distribution of electricity.

Choosing a Full Covered Conductor solution with Ensto accessories is guaranteed to pay for itself in the form of fewer faults, lower maintenance costs, and higher-quality electricity.

Ensto's accessories to Full Covered Conductor lines are electrically and mechanically designed for the best per-

formance and safety. Accessories for medium voltage Full Covered Conductor lines include insulators, tension and suspension clamps, arc protection devices, current limiters, connectors, bird protectors and crossarms.

## Requirements with Covered Conductors

Some additional requirements have been set for Covered Conductors, compared to traditional bare conductor construction:

- Conductors must be handled with care.
- Only accessories designed and approved for the conductor shall be used.
- Arc Protection devices must be used on lines vulnerable to overvoltage.
- Substations must have tripping earth-fault protection devices and alarming secondary devices.

## Arc Protection

Overvoltage is induced on the line usually when lightning strikes on an overhead line or near it. The magnitude of the overvoltage is approximately the same in all phases and may rise to several hundred kilovolts between a phase conductor and earth.

The overvoltage travels along the line to the nearest pole and discharges there by igniting an arc between the crossarm and the conductors. After the overvoltage has discharged a power frequen-

cy short-circuit current start to flow through ionized air, resulting in a power arc between the phases.

Power arc magnitude is normally several kilo amperes. Power arc can move freely along an ordinary bare conductor line towards the load, but in the covered conductor line the covering forms an obstacle. When an arc ignites, it burns a small hole in the covering and keeps burning until the conductor is damaged or burned through.

Circuit breakers cannot respond quickly enough. In order to prevent damage a covered conductor must be protected by installing arc protection devices to appropriate locations. These offer the power arc a safe discharge route without damaging the conductor.

## Placing of the Arc Protection

An Arc Protection device is used to protect the conductors as well as other network components. In this way, it is possible to achieve disruption-free distribution of electricity, a major benefit to the consumer. Arc protection devices must be installed in places in which overvoltage is likely to occur, e.g. fields and hills. Furthermore, protection is required in frequently used areas; for example, buildings, yards, their immediate vicinity, traffic routes and sports fields. The protection chosen also depends on the network's short-circuit values.



# Power Arc Devices (PAD)

With small short-circuit currents, the arc moves slowly thereby stressing the insulator for a longer period.

To avoid damage to the insulator, the arc must be ignited in the arc gap so that the short circuit occurs through the crossarm and trips the circuit breakers. This leads the short-circuit current to the crossarm, tripping the circuit breakers. The arc gapping is designed to withstand stresses caused by high-current short-circuits ( $I_k = 10\text{kA} / 1\text{s}$ ). Power arc devices can be installed on either side of the insulator due to not being dependent on the direction of the power feed. Installation can also be done to different sides of the pole. Power arc devices can be used with tension and suspension insulators.

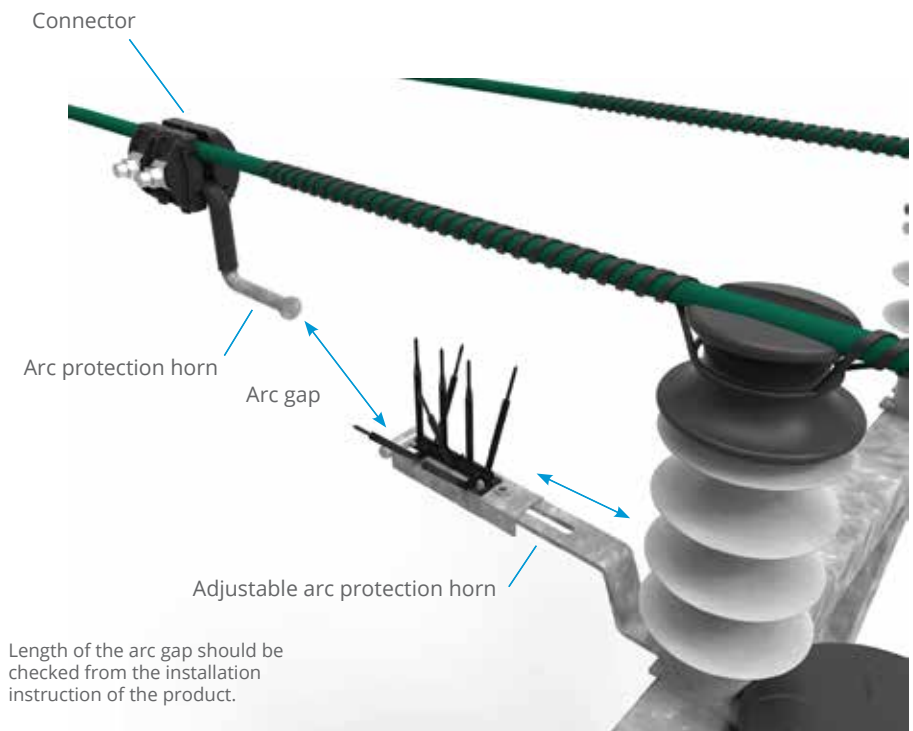

# Current Limiting Devices (CLD)

Current Limiting Devices make uninterrupted electricity possible for customers due to arc protection not causing any high-speed auto-recloser operations.

The economical way to protect a conductor is to use a current limiting device instead of only a surge arrester. This is based on selecting a smaller surge arrester. Under normal operating conditions the smaller surge arrester is not stressed at line voltage as its other end is in the air. A surge arrester should be installed to the crossarm in the same way as the power arc device. Direction of the power feed does not affect the installation therefore it can be placed on either side of the crossarm. The crossarm must always be connected to earth. The density of protection devices installed on line depends on the span length, height of the conductor from the ground level, position of nearby trees and the relief of the terrain.

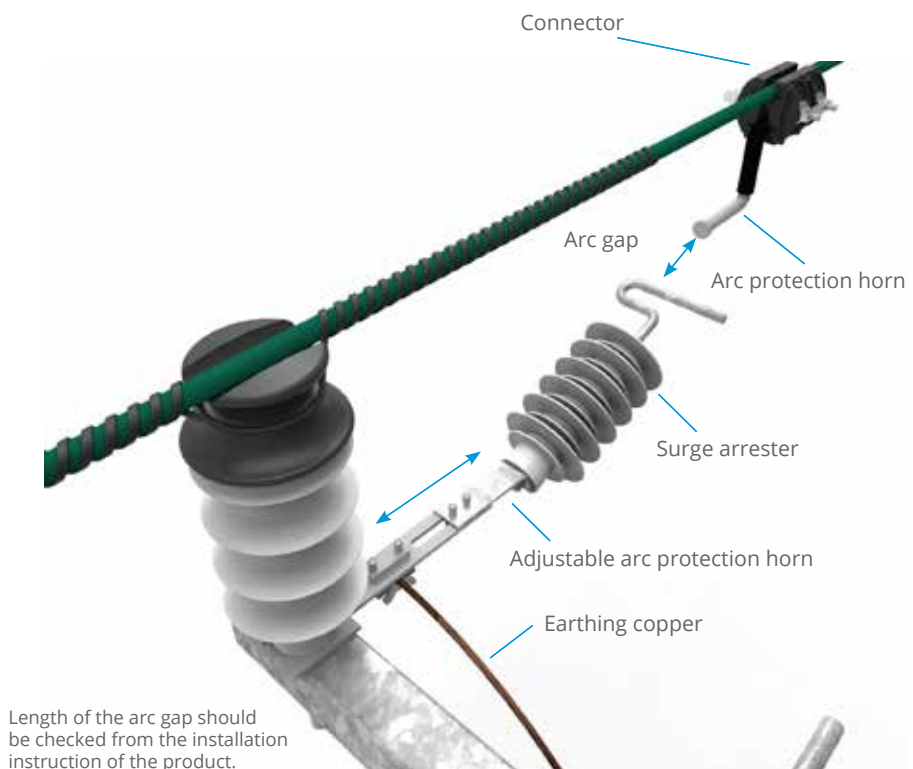

# Wildlife Protection

Covered Conductors are not as vulnerable to damage or disruption, caused by birds or tree branches, as traditional bare conductors.

However, Covered Conductors allow smaller phase distance which increases the risk of such short circuits on cross arms. This risk can be diminished with e.g. twig protector. It prevents tree

branches from sliding along the covering. Also bird protection can be used to prevent birds and tree branches from touching live parts of the line. Insulators have also their own bird protectors.



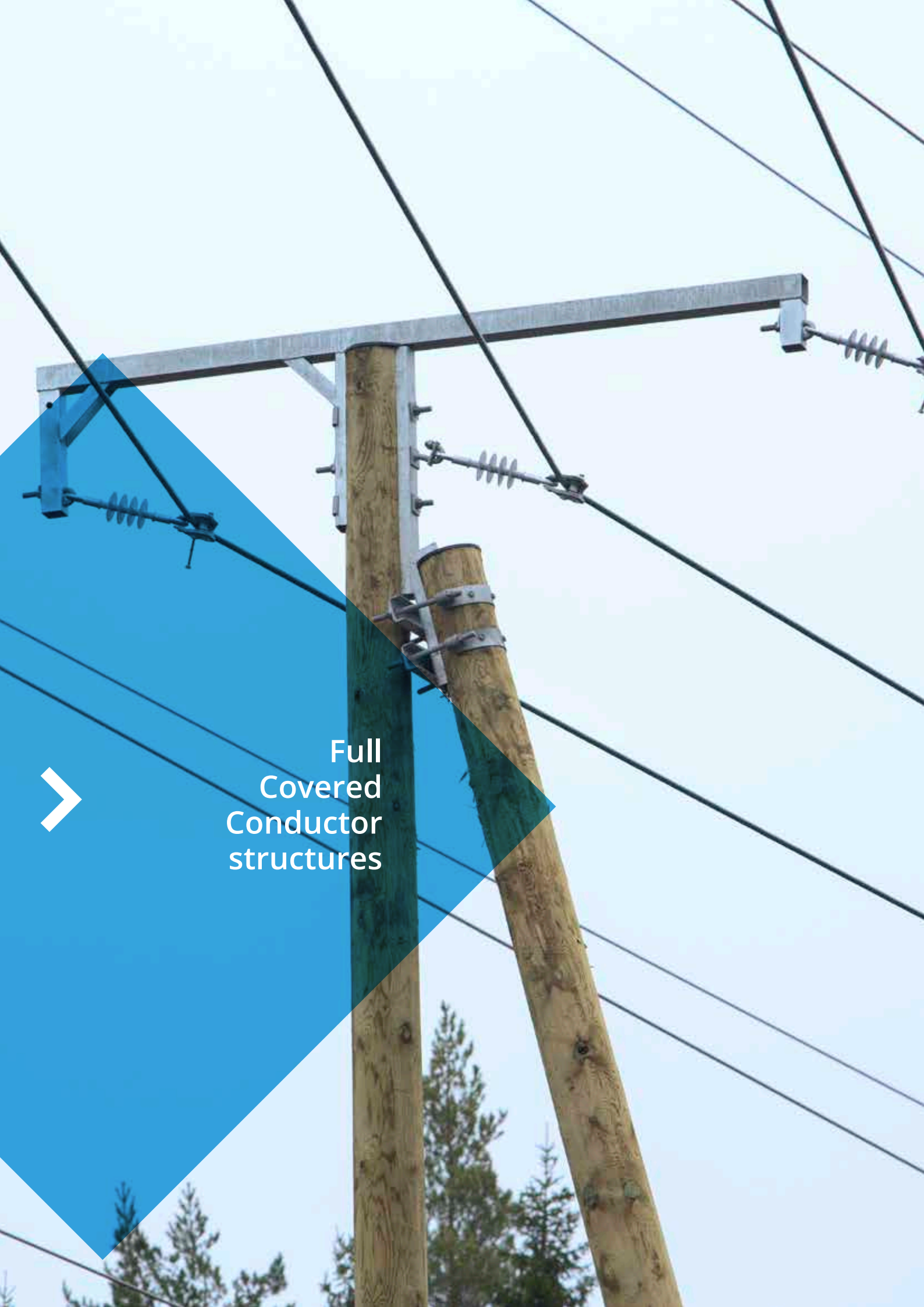

Full  
Covered  
Conductor  
structures

# Suspension structure

## Power arc device protection

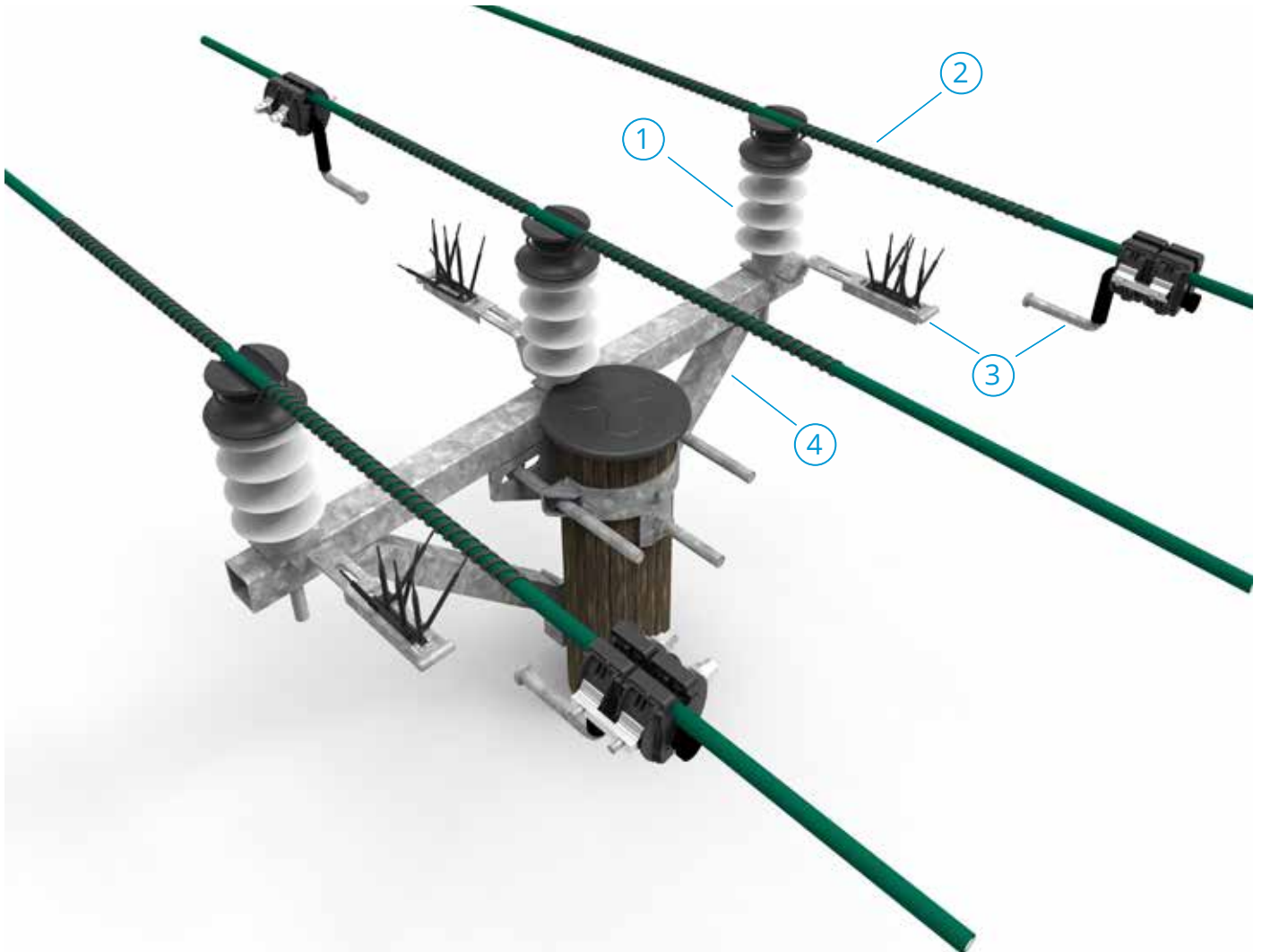

The conductor can be tied to the top-groove or to the neck. In angles, always tie to the neck.

Power arc device protection		Conductor type AAAC 24kV					
		50mm <sup>2</sup>	70mm <sup>2</sup>	99mm <sup>2</sup>	120mm <sup>2</sup>	159mm <sup>2</sup>	241mm <sup>2</sup>
1	Insulators	SDI82.1M20					
2	Ties	SO216.62	SO216.99		SO216.157	SO216.24173	
3	Power arc device	SDI24				SDI29	
4	Crossarm	SH1524.1					

# Suspension structure

## Current limiting device protection

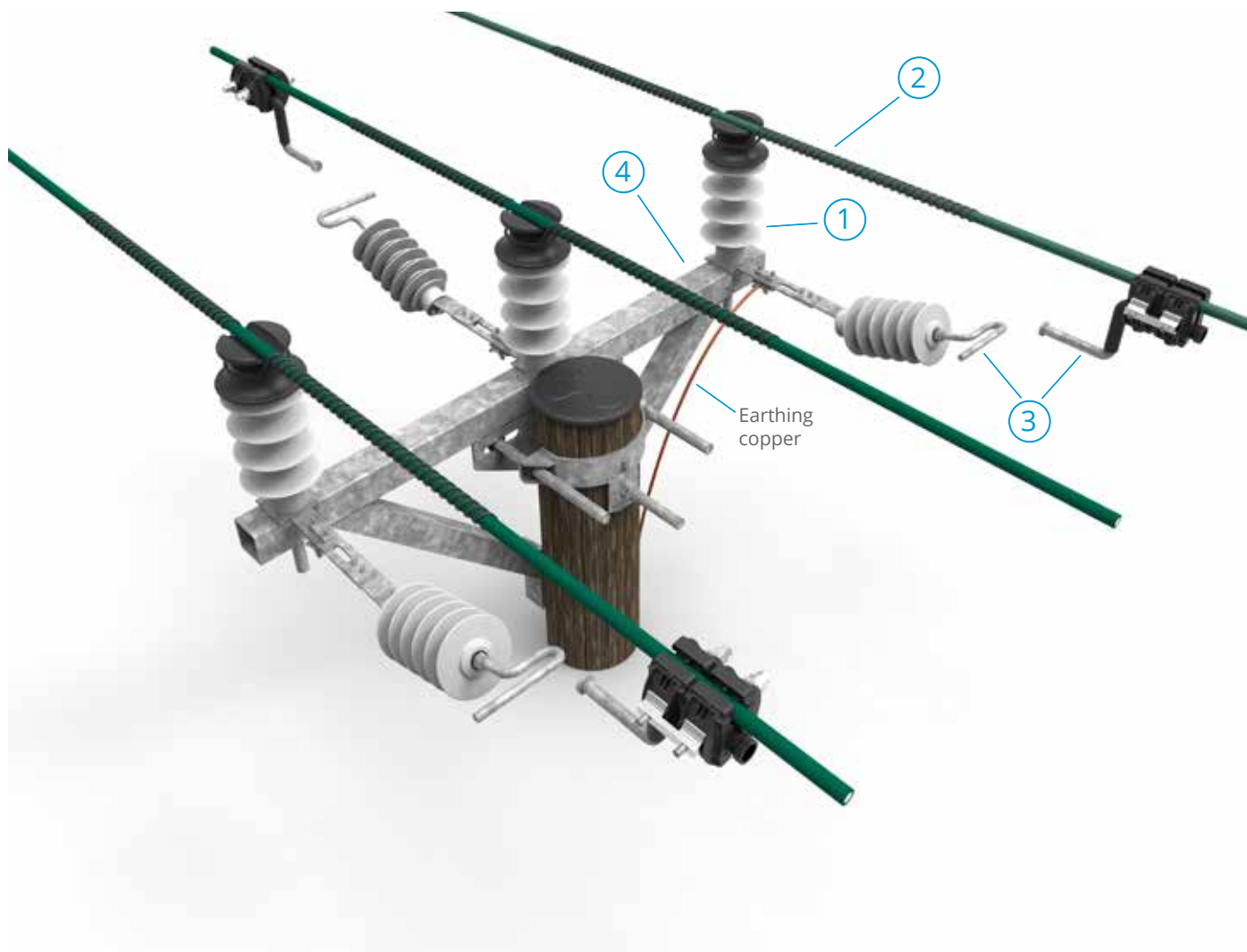

The conductor can be tied to the top-groove or to the neck. In angles, always tie to the neck.

Current limiting device protection		Conductor type AAAC 24kV					
		50mm <sup>2</sup>	70mm <sup>2</sup>	99mm <sup>2</sup>	120mm <sup>2</sup>	159mm <sup>2</sup>	241mm <sup>2</sup>
1	Insulators	SDI82.1M20					
2	Ties	SO216.62		SO216.99		SO216.157	SO216.24173
3	Current limiting protection device	SDI48.5				SDI48.6	
4	Crossarm	SH1524.1					

# Tension structure

## Power arc device protection

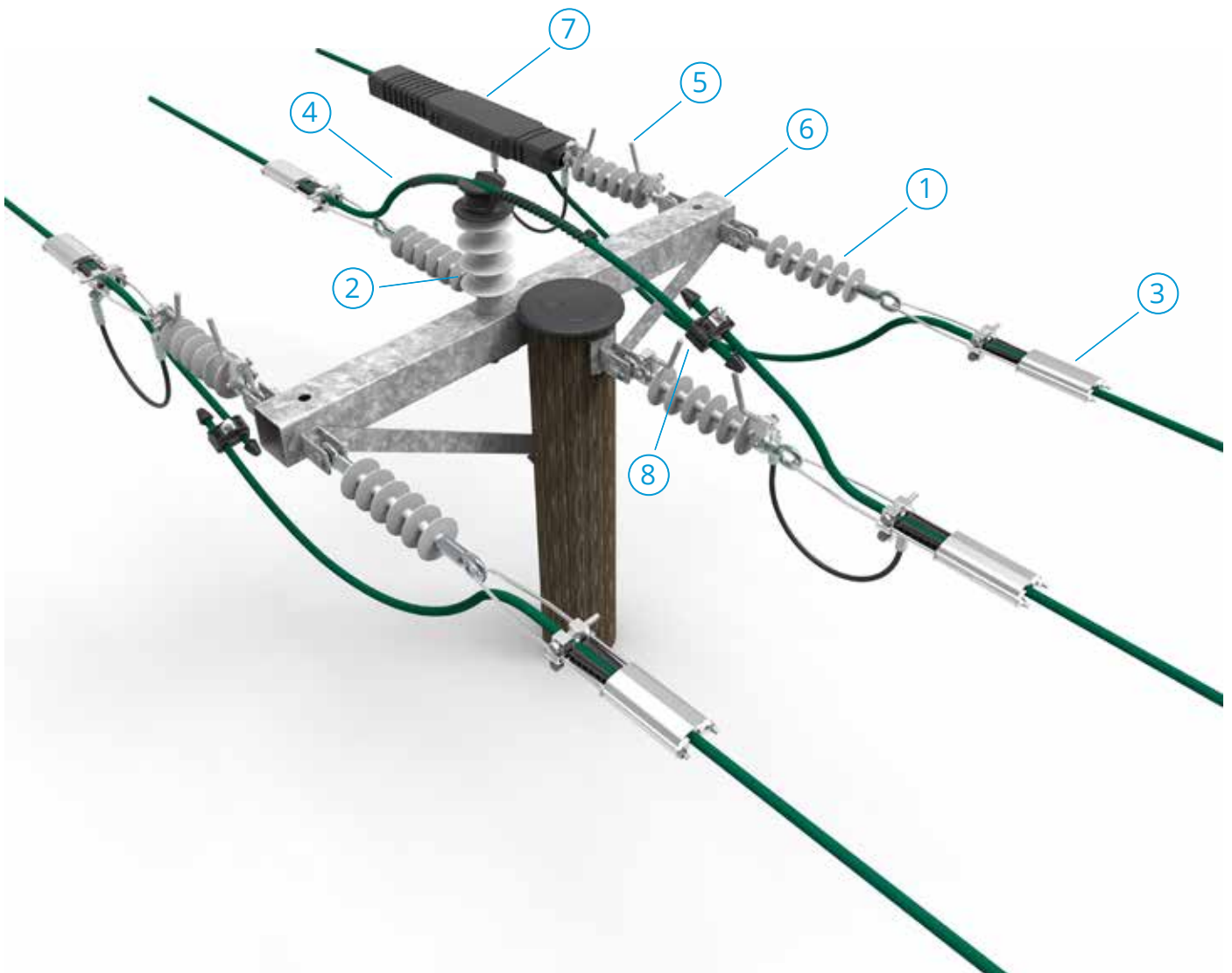

This tension structure is not compatible with 241mm<sup>2</sup> conductor.

Power arc device protection		Conductor type AAAC 24kV				
		50mm <sup>2</sup>	70mm <sup>2</sup>	99mm <sup>2</sup>	120mm <sup>2</sup>	159mm <sup>2</sup>
1	Tension insulators	SDI90.280				
2	Suspension insulator	SDI82.1M20				
3	Clamps	SO255S		SO256S		
4	Ties	SO216.62	SO216.99		SO216.157	
5	Power arc devices	SDI27.1				
6	Crossarm	SH253				
7	Wildlife protection	SP63.3		SP67.3		
8	Connectors	SLW26				

# Tension structure

## Current limiting device protection

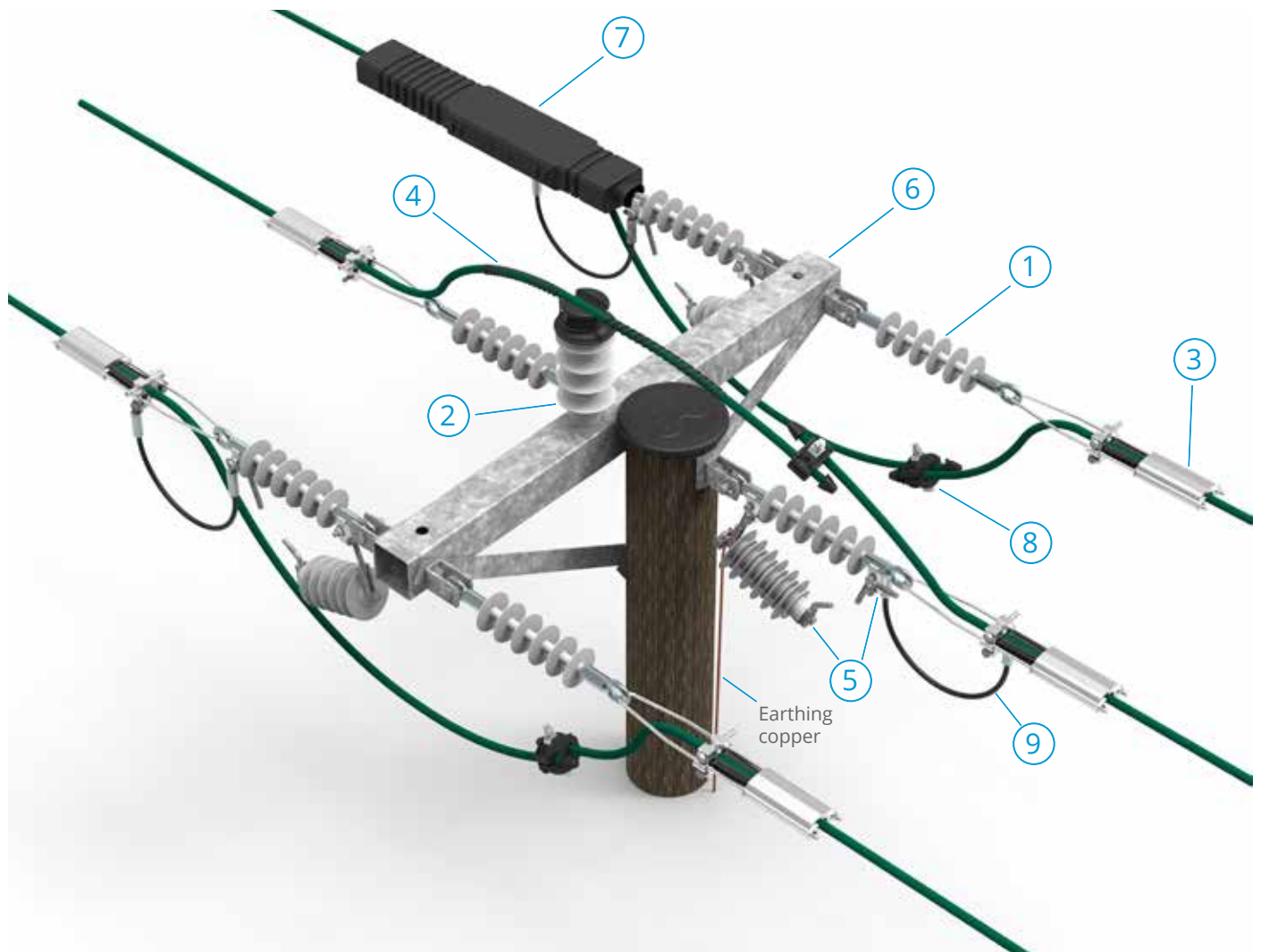

This tension structure is not compatible with 241mm<sup>2</sup> conductor.

**Note:** Current limiting devices meant for tensional installations include a tension insulator.

Current limiting device protection		Conductor type AAAC 24kV				
		50mm <sup>2</sup>	70mm <sup>2</sup>	99mm <sup>2</sup>	120mm <sup>2</sup>	159mm <sup>2</sup>
1	Tension insulators	SDI90.280				
2	Suspension insulator	SDI82.1M20				
3	Clamps	SO255S		SO256S		
4	Ties	SO216.62	SO216.99		SO216.157	
5	Current limiting protection devices	SDI46.824				
6	Crossarm	SH253				
7	Wildlife protection	SP63.3		SP67.3		
8	Connectors	SLW26				
9	Shunt conductor	SDP5				

# Angle structure

## Power arc device protection

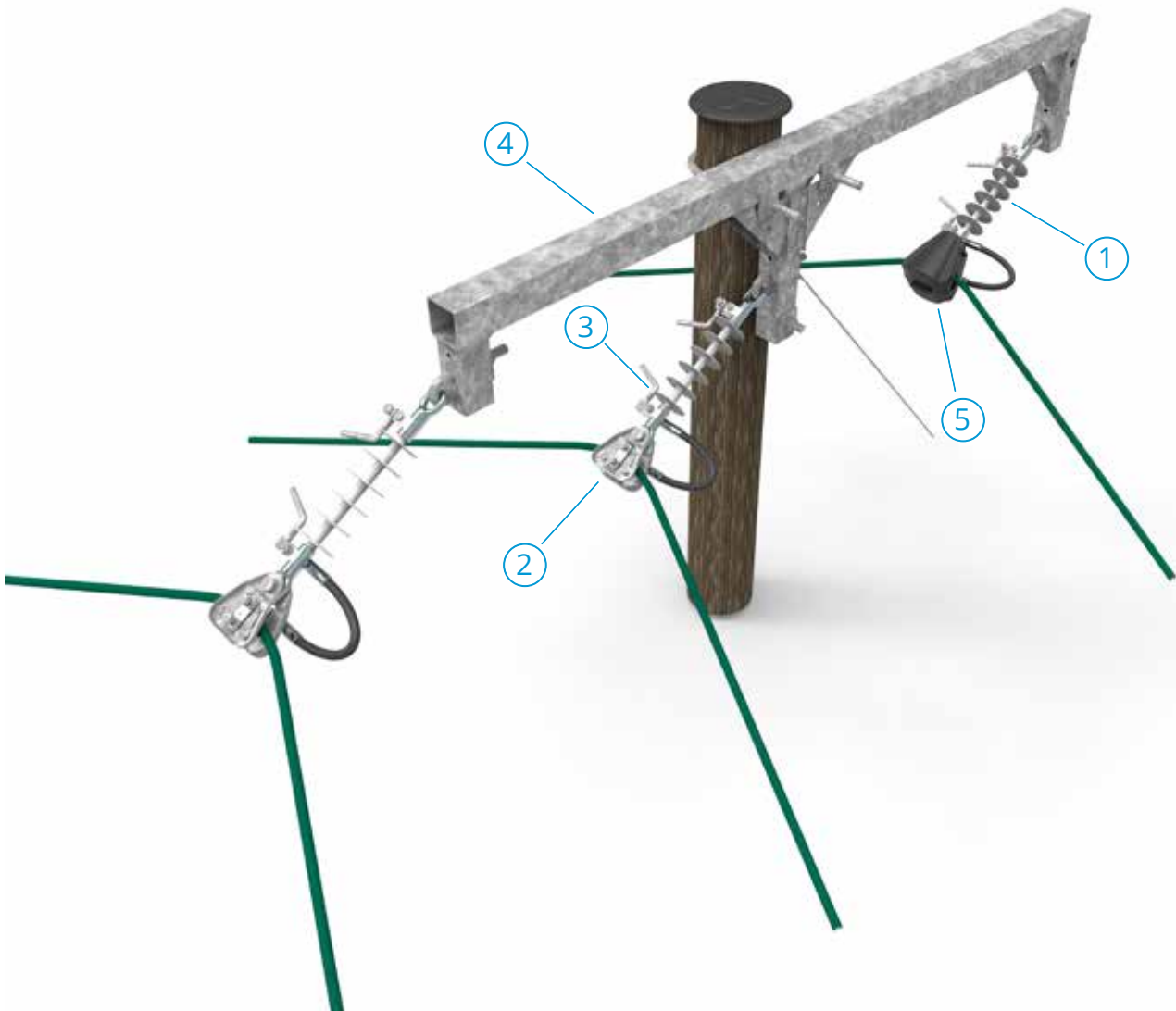

This angle structure is available only with power arc device protection.

Power arc device protection		Conductor type AAAC 24kV					
		50mm <sup>2</sup>	70mm <sup>2</sup>	99mm <sup>2</sup>	120mm <sup>2</sup>	159mm <sup>2</sup>	241mm <sup>2</sup>
1	Insulators	SDI90.280					
2	Clamps	SO181.6S				SO183S	
3	Power arc device	SDI27.1					
4	Crossarm	SH153.10					
5	Wildlife protection	SP62.3				-	

# Terminal structure 1

## Power arc device protection

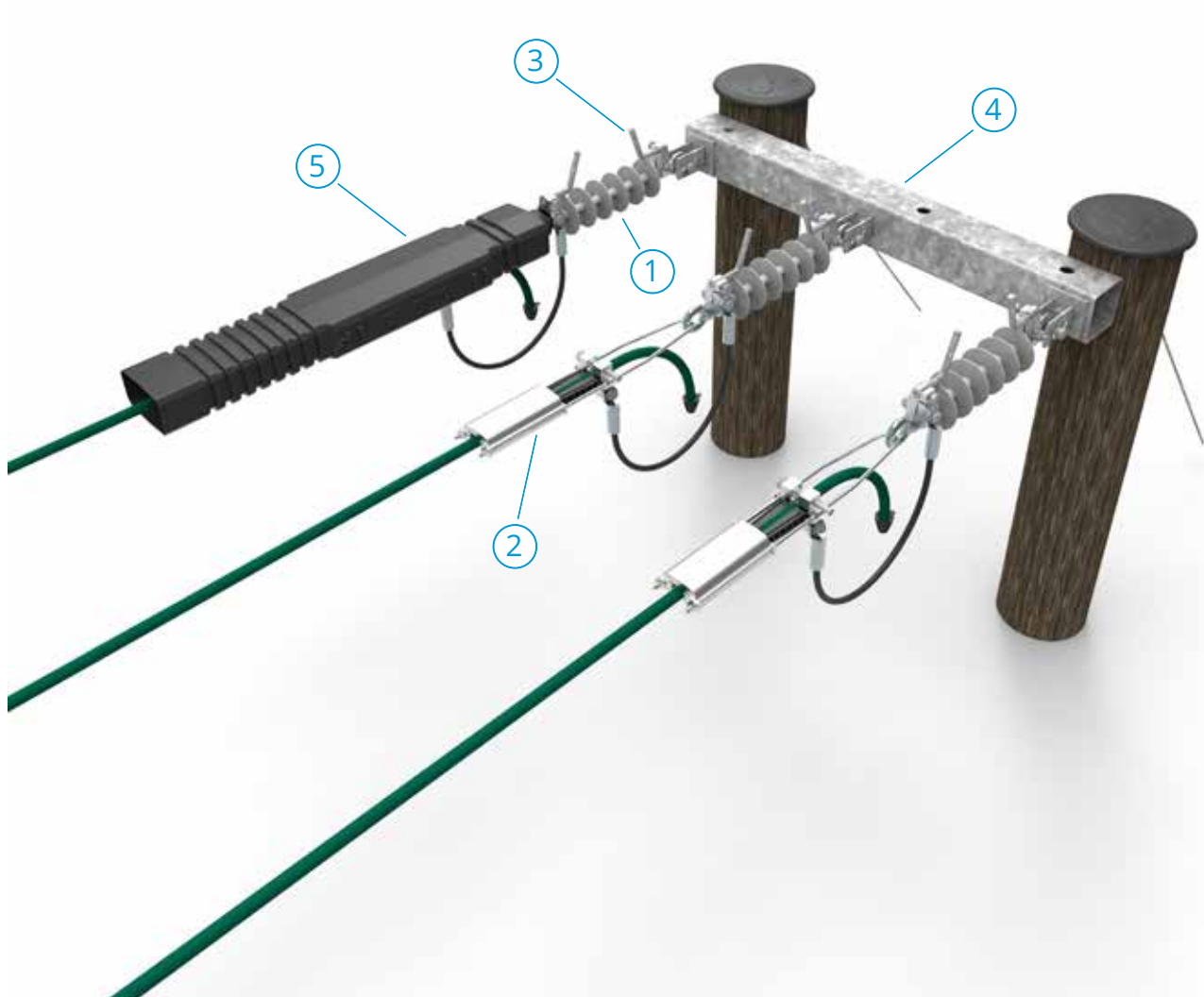

This terminal structure is suitable for narrow corridors.

Power arc device protection		Conductor type AAAC 24kV					
		50mm <sup>2</sup>	70mm <sup>2</sup>	99mm <sup>2</sup>	120mm <sup>2</sup>	159mm <sup>2</sup>	241mm <sup>2</sup>
1	Insulators	SDI90.280					
2	Clamps	SO255S		SO256S		SO257S	
3	Power arc device	SDI27.1					
4	Crossarm	SH156					
5	Wildlife protection	SP63.3		SP67.3		-	

# Terminal structure 1

## Current limiting device protection

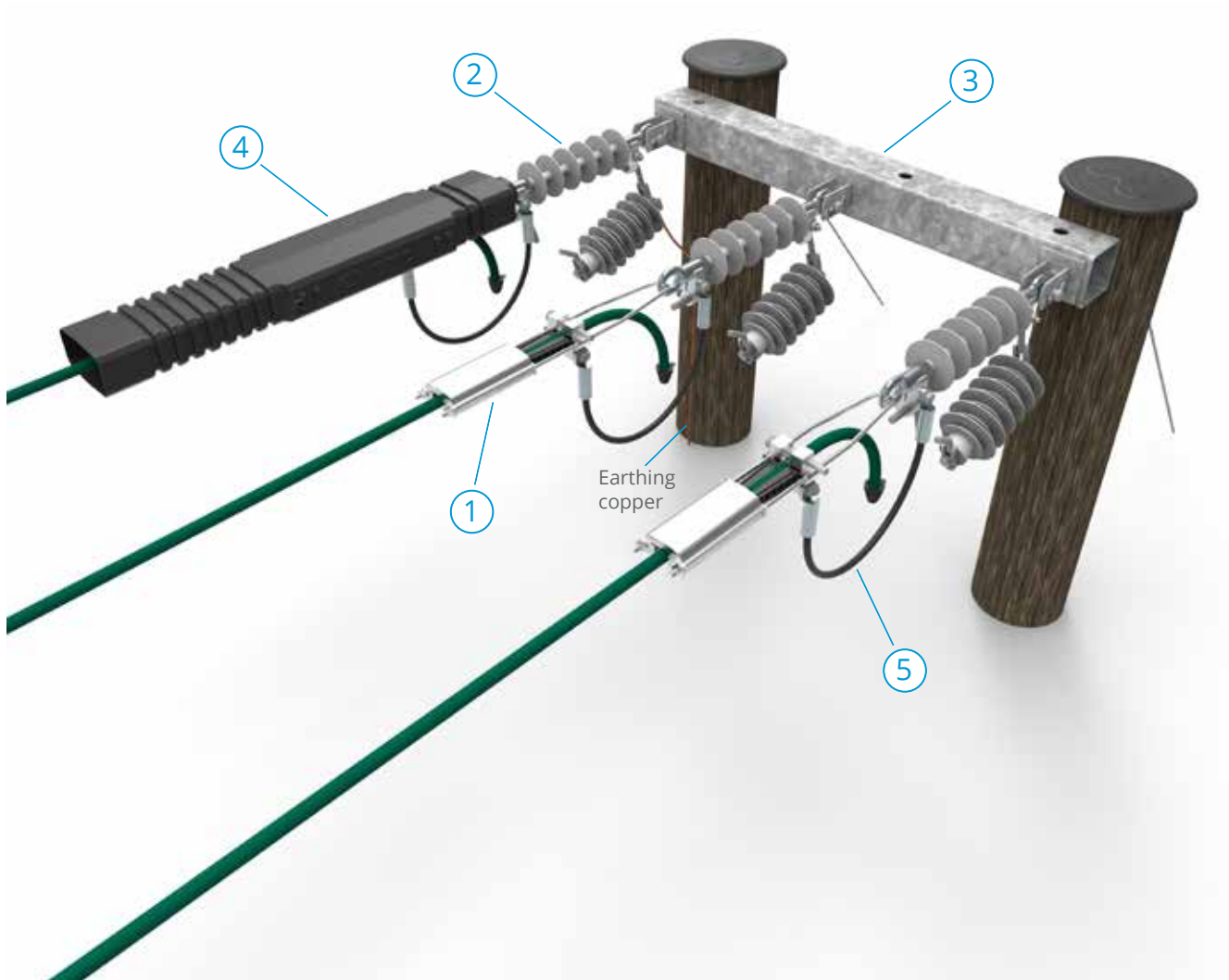

This terminal structure is suitable for narrow corridors.

**Note:** Current limiting devices meant for tensional installations include a tension insulator.

Current limiting device protection		Conductor type AAAC 24kV					
		50mm <sup>2</sup>	70mm <sup>2</sup>	99mm <sup>2</sup>	120mm <sup>2</sup>	159mm <sup>2</sup>	241mm <sup>2</sup>
1	Clamps	SO255S		SO256S		SO257S	
2	Current limiting protection device	SDI46.824					
3	Crossarm	SH156					
4	Wildlife protection	SP63.3		SP67.3		-	
5	Shunt conductor	SDP5					

# Terminal structure 2

## Power arc device protection

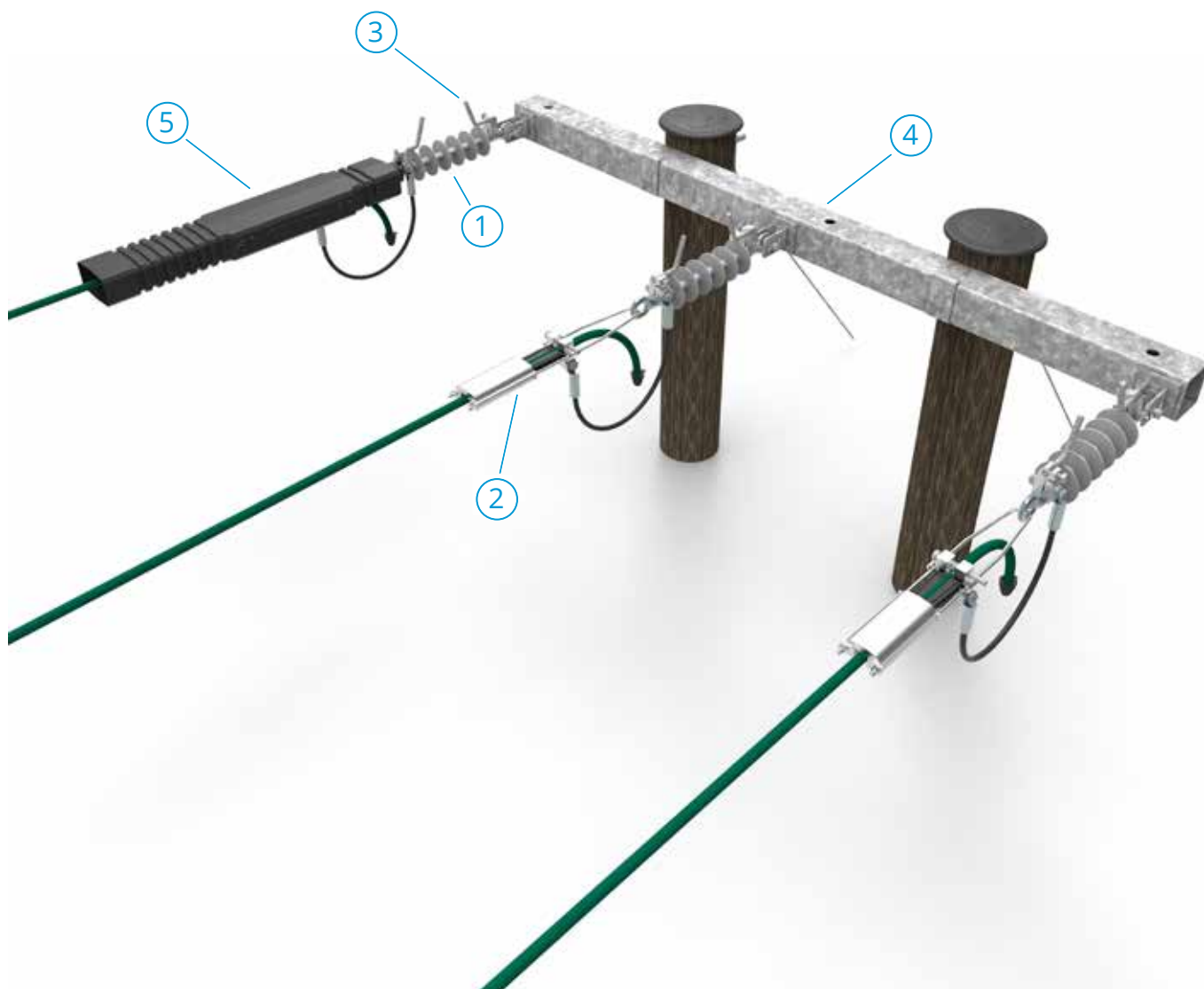

Compared to terminal structure 1, this terminal structure has been equipped with wider crossarm and it has more phase spacing. Longer span lengths can be achieved with this setup.

Power arc device protection		Conductor type AAAC 24kV					
		50mm <sup>2</sup>	70mm <sup>2</sup>	99mm <sup>2</sup>	120mm <sup>2</sup>	159mm <sup>2</sup>	241mm <sup>2</sup>
1	Insulators	SDI90.280					
2	Clamps	SO255S		SO256S		SO257S	
3	Power arc device	SDI27.1					
4	Crossarm	SH179					
5	Wildlife protection	SP63.3		SP67.3		-	

# Terminal structure 2

## Current limiting device protection

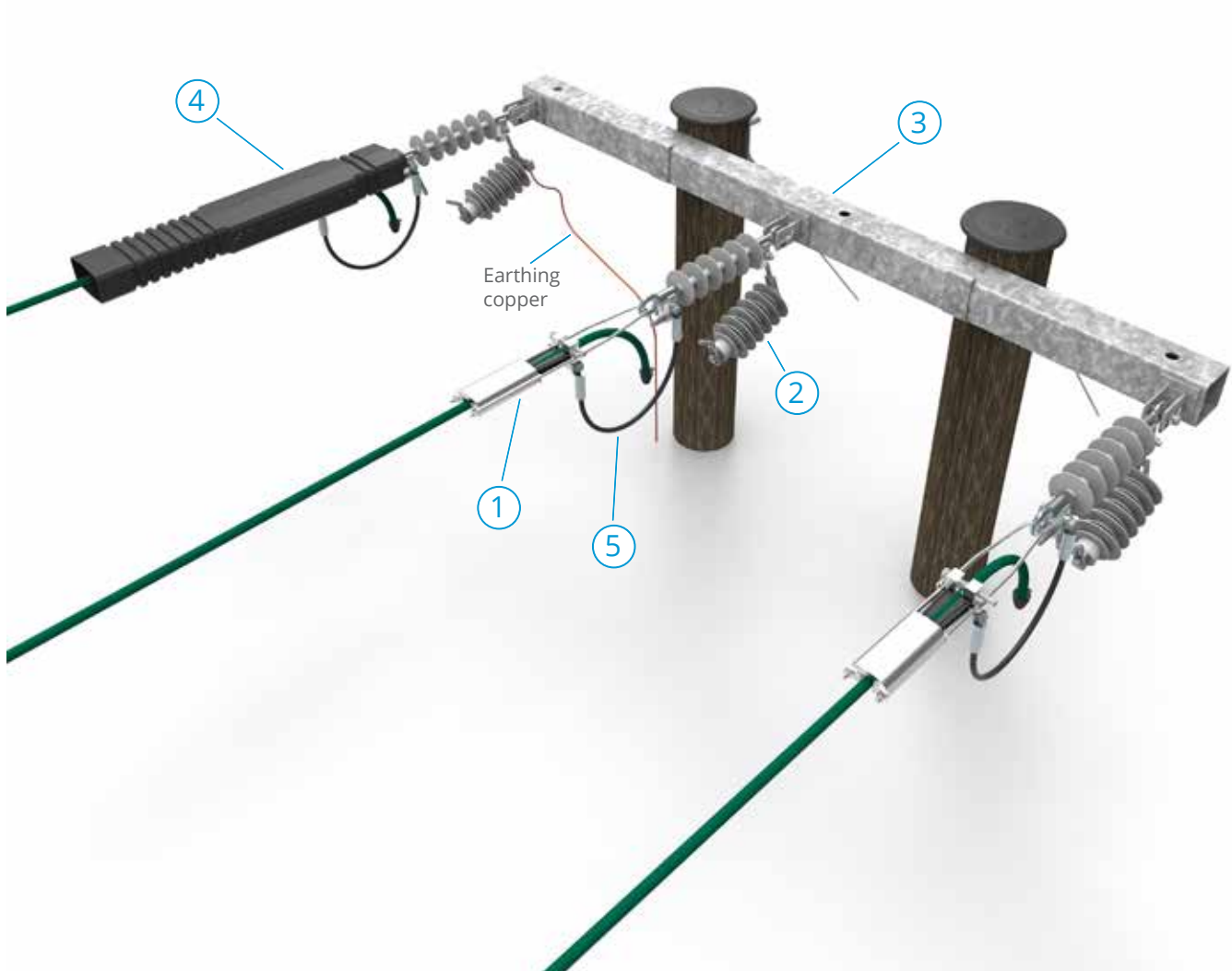

Compared to terminal structure 1, this terminal structure has been equipped with wider crossarm and it has more phase spacing. Longer span lengths can be achieved with this setup. **Note:** Current limiting devices meant for tensional installations include a tension insulator.

Current limiting device protection		Conductor type AAAC 24kV					
		50mm <sup>2</sup>	70mm <sup>2</sup>	99mm <sup>2</sup>	120mm <sup>2</sup>	159mm <sup>2</sup>	241mm <sup>2</sup>
1	Clamps	SO255S		SO256S		SO257S	
2	Current limiting protection device	SDI46.824					
3	Crossarm	SH179					
4	Wildlife protection	SP63.3		SP67.3		-	
5	Shunt conductor	SDP5					

# Angle tension structure

## Power arc device protection

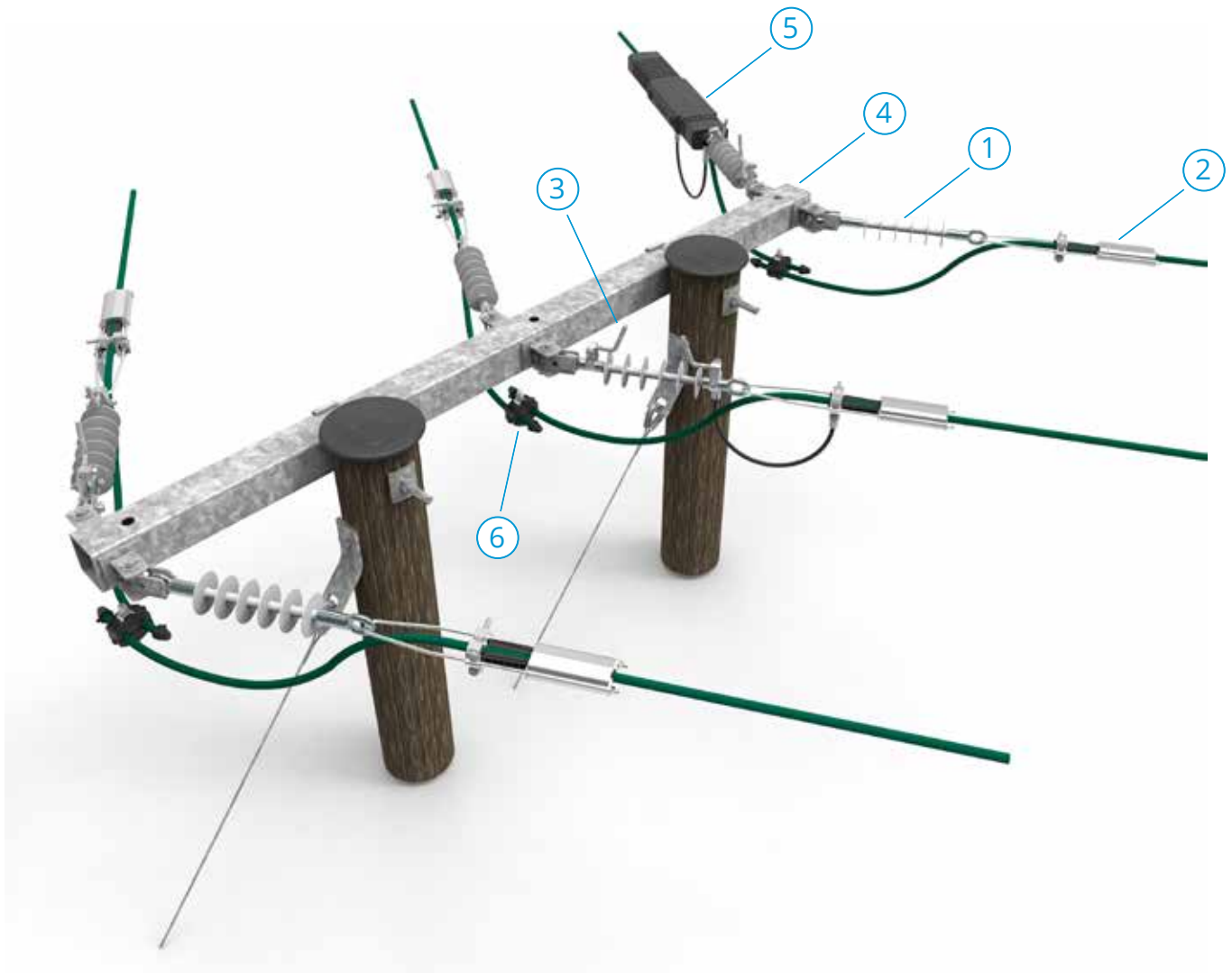

This tension structure is applicable for straight and angle line.

Power arc device protection		Conductor type AAAC 24kV					
		50mm <sup>2</sup>	70mm <sup>2</sup>	99mm <sup>2</sup>	120mm <sup>2</sup>	159mm <sup>2</sup>	241mm <sup>2</sup>
1	Insulators	SDI90.280					
2	Clamps	SO255S		SO256S		SO257S	
3	Power arc device	SDI27.1					
4	Crossarm	SH180					
5	Wildlife protection	SP63.3		SP67.3		-	
6	Connectors	SLW26				SLW27	

# Angle tension structure

## Current limiting device protection

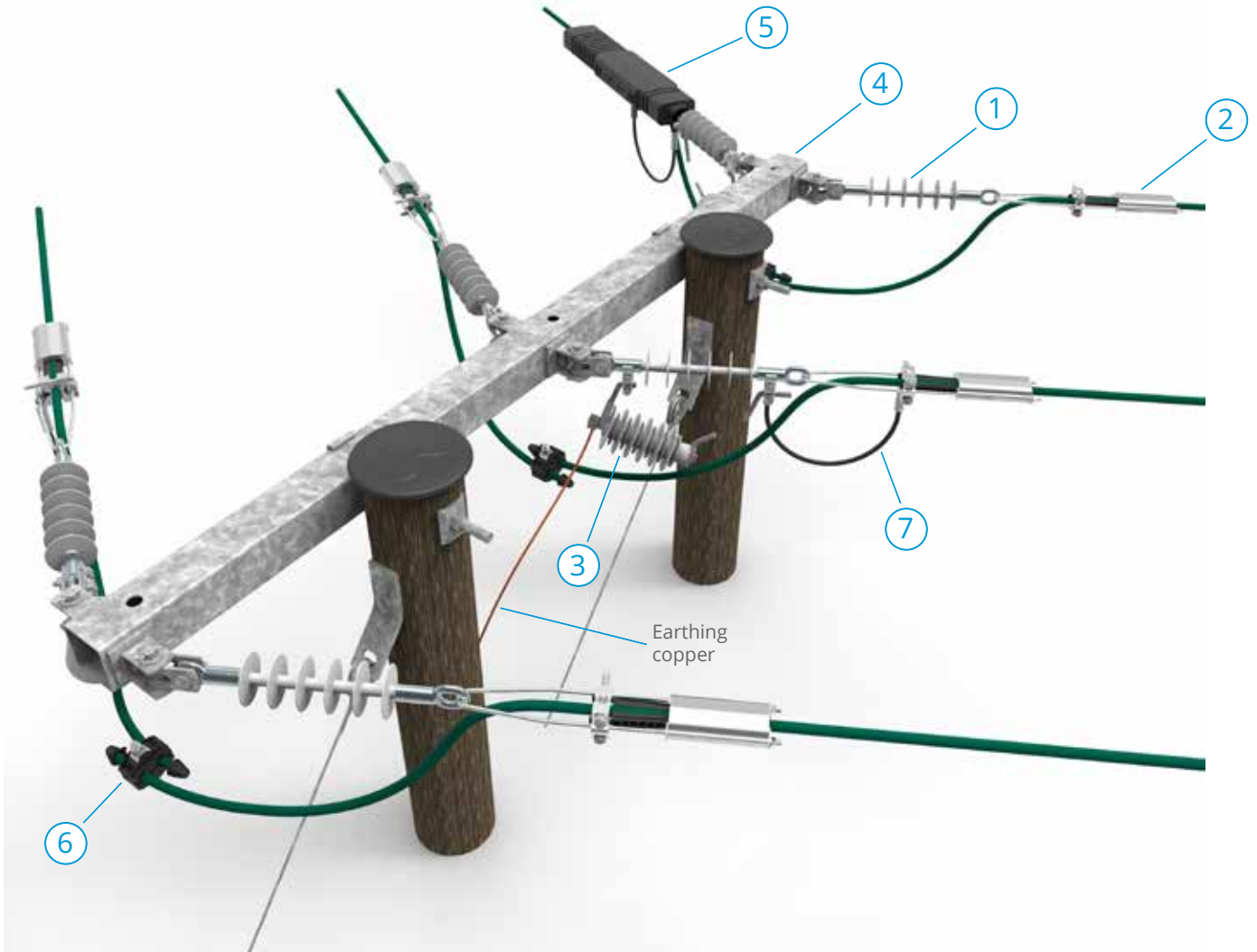

This tension structure is applicable for straight and angle line.

**Note:** Current limiting devices meant for tensional installations include a tension insulator.

Current limiting device protection		Conductor type AAAC 24kV					
		50mm <sup>2</sup>	70mm <sup>2</sup>	99mm <sup>2</sup>	120mm <sup>2</sup>	159mm <sup>2</sup>	241mm <sup>2</sup>
1	Insulators	SDI90.280					
2	Clamps	SO255S		SO256S		SO257S	
3	Current limiting protection device	SDI46.824					
4	Crossarm	SH180					
5	Wildlife protection	SP63.3		SP67.3		-	
6	Connectors	SLW26				SLW27	
7	Shunt conductor	SDP5					



# Crossarms - Limits of service

Please, note that the limits of service given in this brochure concern only crossarms manufactured and sold by Ensto.

## General

### Standards

#### SFS-EN 50341-1:2014

Overhead electrical lines exceeding AC 1kV – Part 1: General requirements – Common specifications

#### SFS-EN 50341-2-7:2015

Overhead electrical lines exceeding AC 1kV – National Normative Aspects (NNA) for FINLAND (based on EN 50341-1:2012)

Limits of service given in this brochure have been calculated acc. to the EN-standards mentioned above.

### Basis of design

Limits of service given in this brochure are based on grid design recommendations given by Finnish Energy's (Energiateollisuus ry) workgroup. They have been calculated according to the basic alternatives offered by the workgroup which are:

- Reliability level  
(EN 50341-2-7, clause 3.2.2)
  - Level 1 (Normal lines)
  - Level 2 (45kV lines)
- Wind forces  
(EN 50341-2-7, clause 4.3)
  - Basic gust wind speed,  $V_b = 21\text{m/s}$
  - Terrain type II
- Conductor ice loads  
(EN 50341-2-7, clause 4.5)
  - Icing category I (reference ice load 10N/m)

### Load cases

The service limits have been calculated in following load cases (No. column numbers refer to standard EN 50341-2-7, clause 4.13)

No.	Load case	Temperature °C
-	Everyday stress	0
1a	Extreme wind	0
1b	Extreme low temperature	-50 (acc. to northern Finland)
2a	Extreme ice	0
3a	Extreme ice + reduced wind	0
3b	Reduced wind + ice	0
4	Construction, maintenance	-20
-	Hot weather	50
-	Hot weather after ice load	50
-	Hot weather after freezing temperatures	50

Different load cases were used to calculate the phase to phase distances, phase spacing to crossarm- and pole structures and allowed loads for crossarms and conductors. With wind loads the calculation was done from opposite sides to ensure that the distances between live parts and line structures were enough. According to EN-standards, when calculating with combined wind and ice loads, the phase to phase distances are not relevant.



## Graphs

Basically every crossarm has 2 graphs:

- Function of line angle to line span
- Function of Sum Y to line span

X-axis presents the line span in meters and Y-axis either the line angle or Sum Y. With such terminal- and tension crossarms that are not to be used in angle installations, there is only one graph showing the allowed maximum span lengths with different conductors.

## Equivalent span

Equivalent span is the span calculated from a tensional line section that is used to calculate the forces when the tensional line section contains more than one span (see EN 50341-1 clause 4.12.1).

## Sum Y

Sum Y is calculated as a sum of tangents of the rising angles of adjacent poles. The rising angle of a pole is the angle of lines drawn between the conductor's attaching points in poles and the level of the conductor's attaching point in pole that is under calculation. See example below of calculating the Sum Y of pole P3.

## Everyday stress (EDS)

Each graph shows the everyday stress value that was used in the calculation.

## Impact of next crossarm

When calculating limits of service for a crossarm, properties of the crossarm next on the line has to be noted also such as phase-to-phase distances and

insulator types. The limits of service here have been calculated only in basic situations such as suspension crossarm > suspension crossarm. For special cases the limits of service have to be calculated separately.

## Installation of a crossarm

In line angles the crossarm has to be installed in a way, where the line angles are as even as possible on both sides of the crossarm. Such termination- and tension crossarms that use regular conductor fixing point should be installed without any line angle. Line angle termination and tension installations demand a specific fixing method.

## ➤ Defining the Sum Y of Pole P3

Sum Y is calculated as a sum of tangents of the rising angles of adjacent poles.

Calculating sum Y:

$$Y1 = \tan a = (H3 - H1) / S1$$

$$Y2 = \tan b = (H3 - H2) / S2$$

$$\text{Sum Y} = Y1 + Y2$$

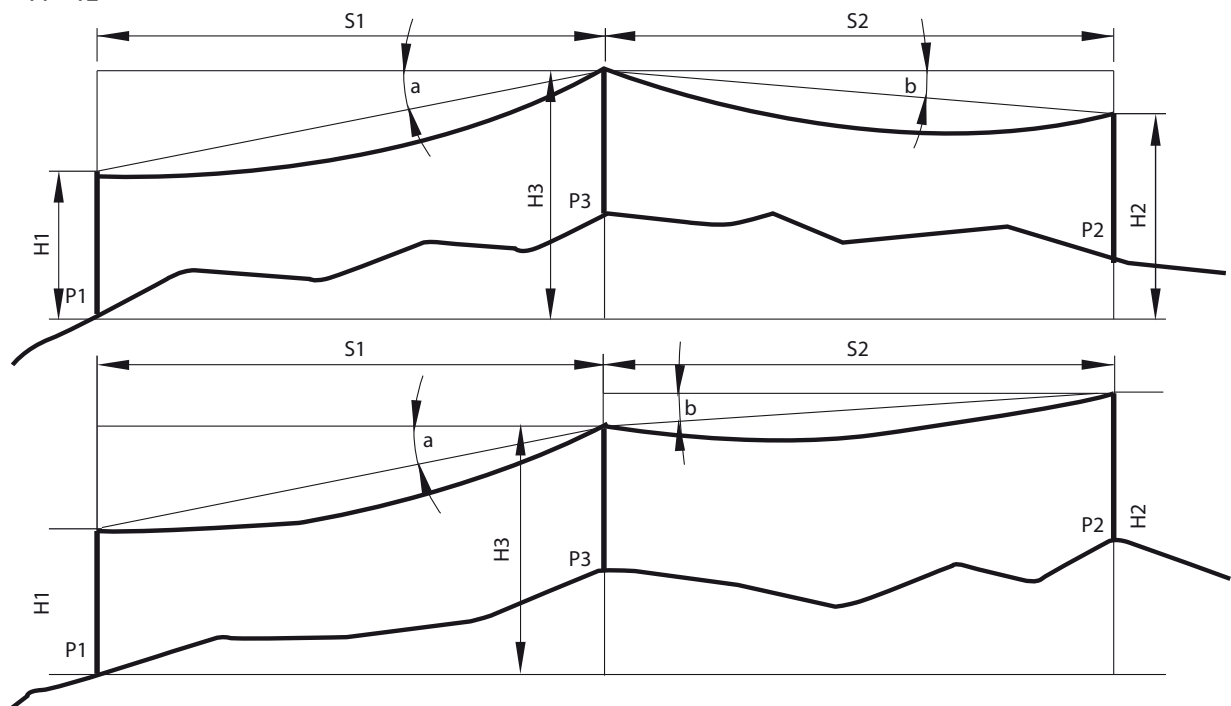

# Limits of service

Line angle graphs have been calculated with Sum Y = 0. Sum Y graphs of tension and suspension crossarms have been calculated with line angle = 0°. Sum Y graphs of angle crossarms have been calculated with line angle = 45° (except SH153.10 with line angle = 25°). In the graphs X-axis represents the length of line angle in meters and Y-axis represents either Line angle or Sum Y depending on the graph.

## Angle crossarm SH153.10

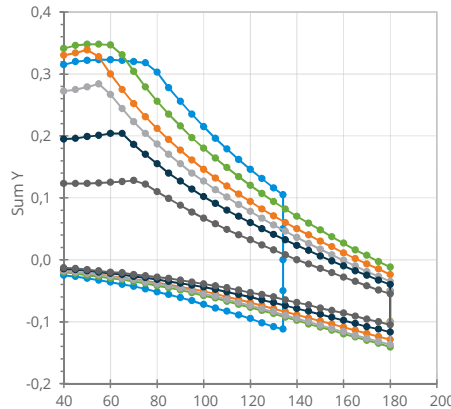
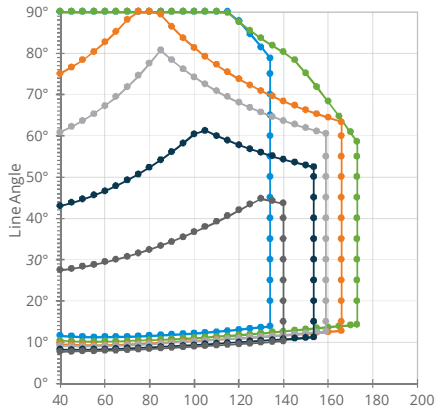

Allowed loads for the crossarm at conductor fixing points are:  
 $F_x=14.0\text{kN}$  angle load  
 $F_z=4.5\text{kN}$  horizontally along conductor  
 $F_y=4.0\text{kN}$  vertically downwards

EDS values for conductors:

- CCST AAAC 50 30 N/mm<sup>2</sup>
- CCST AAAC 70 30 N/mm<sup>2</sup>
- CCST AAAC 99 30 N/mm<sup>2</sup>
- CCST AAAC 120 30 N/mm<sup>2</sup>
- CCST AAAC 159 30 N/mm<sup>2</sup>
- CCST AAAC 241 30 N/mm<sup>2</sup>

## Angle tension crossarm SH180

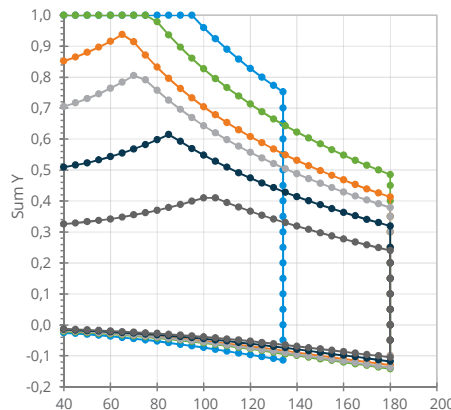
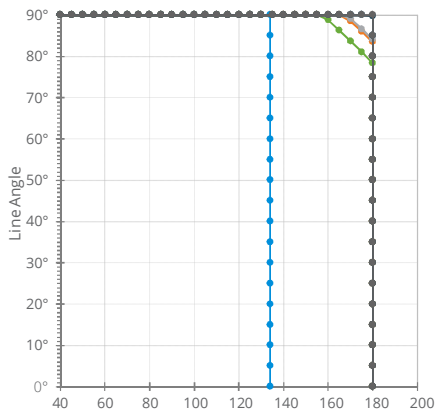

Allowed loads for the crossarm at conductor fixing points are:  
 $F_x=33\text{kN}$  angle load  
 $F_z=33\text{kN}$  horizontally along conductor  
 $F_y=5\text{kN}$  vertically downwards

EDS values for conductors:

- CCST AAAC 50 30 N/mm<sup>2</sup>
- CCST AAAC 70 30 N/mm<sup>2</sup>
- CCST AAAC 99 30 N/mm<sup>2</sup>
- CCST AAAC 120 30 N/mm<sup>2</sup>
- CCST AAAC 159 30 N/mm<sup>2</sup>
- CCST AAAC 241 30 N/mm<sup>2</sup>

## Suspension crossarm SH1524.1

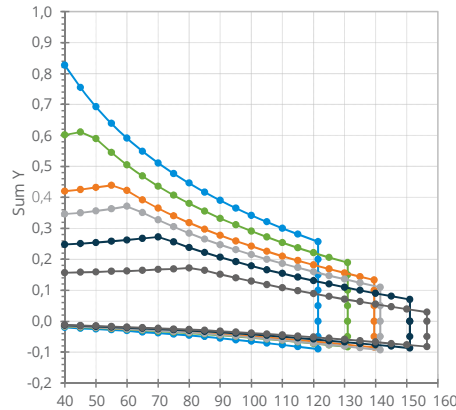
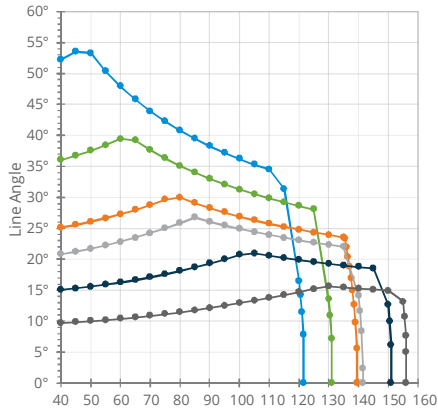

Allowed loads for the crossarm at conductor fixing points are:  
 $F_x=5\text{kN}$  angle load  
 $F_z=5\text{kN}$  horizontally along conductor  
 $F_y=5\text{kN}$  vertically downwards

EDS values for conductors:

- CCST AAAC 50 30N/mm<sup>2</sup>
- CCST AAAC 70 30N/mm<sup>2</sup>
- CCST AAAC 99 30N/mm<sup>2</sup>
- CCST AAAC 120 30N/mm<sup>2</sup>
- CCST AAAC 159 30N/mm<sup>2</sup>
- CCST AAAC 241 30N/mm<sup>2</sup>

## Terminal crossarm SH156

Span length with conductors when the phase spacing of the next crossarm is 500mm

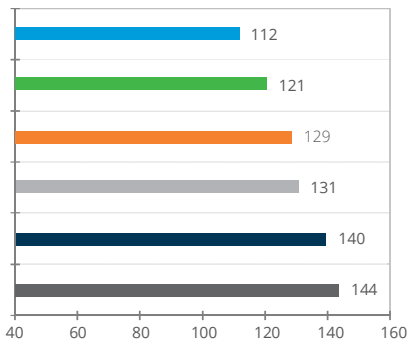

## Terminal crossarm SH179

Span length with conductors when the phase spacing of the next crossarm is 500mm

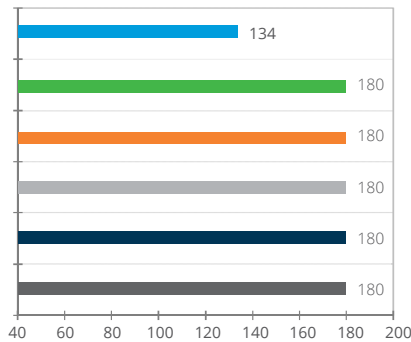

Allowed loads for the crossarm at conductor fixing points are for SH156:  
 $F_z=26.0\text{kN}$  horizontally along conductor  
 and for SH179:  
 $F_z=25.0\text{kN}$  horizontally along conductor

EDS values for conductors:

- CCST AAAC 50 30 N/mm<sup>2</sup>
- CCST AAAC 70 30 N/mm<sup>2</sup>
- CCST AAAC 99 30 N/mm<sup>2</sup>
- CCST AAAC 120 30 N/mm<sup>2</sup>
- CCST AAAC 159 30 N/mm<sup>2</sup>
- CCST AAAC 241 30 N/mm<sup>2</sup>

## Tension crossarm SH253

Span length with conductors when the phase spacing of the next crossarm is 500mm

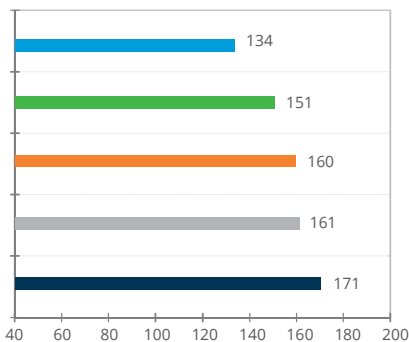

Allowed loads for the crossarm at conductor fixing points are:  
 $F_z=16,5\text{ kN}$  horizontally along conductor.

EDS values for conductors:

- CCST AAAC 50 30N/mm<sup>2</sup>
- CCST AAAC 70 30N/mm<sup>2</sup>
- CCST AAAC 99 30N/mm<sup>2</sup>
- CCST AAAC 120 30N/mm<sup>2</sup>
- CCST AAAC 159 30N/mm<sup>2</sup>



# CCST AAAC 12/20 (24) kV

CCST is a round-wire, non-compacted, thermoplastic covered conductor. The All Aluminum Alloy Conductor, AAAC is longitudinally water blocked. All three layers are extruded in the same process. The UV-protected HDPE-jacket is both abrasion and tracking resistant.

- Conductor – AAAC
- Extruded, longitudinal waterblocking layer
- Extruded, inner semiconductive layer
- Insulation of PE
- Outer layer of UV-resistant HDPE

Minimum bending radius: 15 x diameter.  
 Lowest temperature for installation: -15°C.  
 Maximum continuous temperature: +70°C.

## Standard

Conductor EN 50397-1

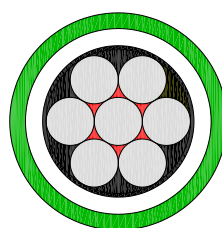

Sizes:  
50, 70, 99, 120mm<sup>2</sup>

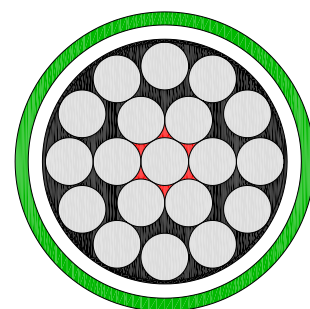

Sizes:  
159, 241mm<sup>2</sup>

AAAC							
Crosssection	50	70	99	120	159	241	mm <sup>2</sup>
Lay up of conductor	7x3,08	7x3,57	7x4,25	7x4,67	19x3,26	19x4,02	-
Conductor diameter, bare conductor, nom	9,24	10,71	12,75	14,01	16,3	20,1	mm
Inner semi conductive layer, thickness, nom	0,3	0,3	0,3	0,3	0,3	0,3	mm
Inner PE covering, thickness, nom	1,2	1,2	1,2	1,2	1,2	1,2	mm
Outer UV-resist. HDPE-covering, thickness, nom	1,1	1,1	1,1	1,1	1,1	1,1	mm
Diameter over covering, min - max	13,9-15,3	15,4-16,8	17,4-18,8	18,7-20,1	20,9-22,4	24,7-26,2	mm
Weight, nom	247	313	417	488	635	920	kg/km
Rated operating voltage	20(24)	20(24)	20(24)	20(24)	20(24)	20(24)	kV
DC-resistance at 20°C, maximum	0,600	0,445	0,318	0,263	0,197	0,129	ohm/km
Resistance temp. coefficient	0,004	0,004	0,004	0,004	0,004	0,004	/°C
Lightening impulse withstand strength of HDPE layer	100	100	100	100	100	100	kV
Operating temperature, maximum	70	70	70	70	70	70	°C
Max load(IEC 61597), cond.temp 70°C, air temp. 20°C, wind speed 0,5m/s, approximate value	233	281	350	395	474	621	A
Max short circuit current, 1 sec. 50-200°C	5,1	6,8	9,6	11,7	15,3	23,4	kA
Tensile strength of conductor, minimum	14,3	18,6	25,3	30,6	42,0	61,5	kN
Aluminium alloy	AL7	AL7	AL7	AL7	AL7	AL7	-

All illustrations and specifications of weights, size and dimensions are indicative only EN50397-1

# Regulation tables

Regulation tables given below show the sag of the conductor depending on temperature, tensional force and span length. The sag is the height difference between lowest point of the conductor and adjacent conductor fixing points in poles.

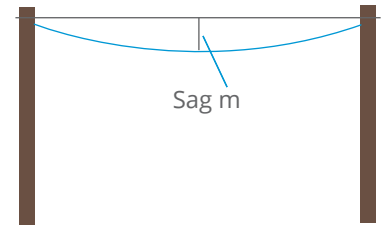

## CCST AAAC 50mm<sup>2</sup>, 20(24)kV

Conductor area = 52 mm<sup>2</sup>, CCST AlMgSi, 20(24)kV,  
Equivalent span = 80 m, Stress value in conductor at 0°C = 30N/mm<sup>2</sup>

Cond.-temp	Tensile-force	Sag in meters at a span																	
		10	20	30	40	50	60	70	80	90	100	110	120	130	140	150	160	170	180
50	981	0,03	0,12	0,28	0,49	0,77	1,11	1,51	<b>1,97</b>	2,50	3,08	3,73	4,44	5,21	6,04	6,93	7,89	8,90	9,98
45	1015	0,03	0,12	0,27	0,48	0,75	1,07	1,46	<b>1,91</b>	2,41	2,98	3,61	4,29	5,04	5,84	6,71	7,63	8,61	9,66
40	1051	0,03	0,12	0,26	0,46	0,72	1,04	1,41	<b>1,84</b>	2,33	2,88	3,48	4,14	4,86	5,64	6,47	7,36	8,31	9,32
35	1092	0,03	0,11	0,25	0,44	0,69	1,00	1,36	<b>1,77</b>	2,24	2,77	3,35	3,99	4,68	5,43	6,23	7,09	8,00	8,97
30	1137	0,03	0,11	0,24	0,43	0,66	0,96	1,30	<b>1,70</b>	2,15	2,66	3,22	3,83	4,49	5,21	5,98	6,81	7,68	8,61
25	1188	0,03	0,10	0,23	0,41	0,64	0,92	1,25	<b>1,63</b>	2,06	2,55	3,08	3,67	4,30	4,99	5,73	6,52	7,36	8,25
20	1244	0,02	0,10	0,22	0,39	0,61	0,88	1,19	<b>1,56</b>	1,97	2,43	2,94	3,50	4,11	4,76	5,47	6,22	7,03	7,88
15	1308	0,02	0,09	0,21	0,37	0,58	0,83	1,13	<b>1,48</b>	1,87	2,31	2,80	3,33	3,91	4,53	5,20	5,92	6,68	7,49
10	1381	0,02	0,09	0,20	0,35	0,55	0,79	1,07	<b>1,40</b>	1,77	2,19	2,65	3,15	3,70	4,29	4,93	5,61	6,33	7,10
5	1464	0,02	0,08	0,19	0,33	0,52	0,74	1,01	<b>1,32</b>	1,67	2,07	2,50	2,97	3,49	4,05	4,65	5,29	5,97	6,69
0	1560	0,02	0,08	0,17	0,31	0,48	0,70	0,95	<b>1,24</b>	1,57	1,94	2,35	2,79	3,28	3,80	4,36	4,96	5,60	6,28
-5	1670	0,02	0,07	0,16	0,29	0,45	0,65	0,89	<b>1,16</b>	1,47	1,81	2,19	2,61	3,06	3,55	4,07	4,64	5,23	5,87
-10	1799	0,02	0,07	0,15	0,27	0,42	0,61	0,82	<b>1,08</b>	1,36	1,68	2,03	2,42	2,84	3,30	3,78	4,30	4,86	5,45
-15	1947	0,02	0,06	0,14	0,25	0,39	0,56	0,76	<b>0,99</b>	1,26	1,55	1,88	2,24	2,62	3,04	3,49	3,98	4,49	5,03
-20	2120	0,01	0,06	0,13	0,23	0,36	0,51	0,70	<b>0,91</b>	1,16	1,43	1,73	2,05	2,41	2,80	3,21	3,65	4,12	4,62
-25	2317	0,01	0,05	0,12	0,21	0,33	0,47	0,64	<b>0,84</b>	1,06	1,31	1,58	1,88	2,21	2,56	2,94	3,34	3,77	4,23
-30	2540	0,01	0,05	0,11	0,19	0,30	0,43	0,58	<b>0,76</b>	0,96	1,19	1,44	1,71	2,01	2,33	2,68	3,05	3,44	3,86

## CCST AAAC 70mm<sup>2</sup>, 20(24)kV

Conductor area = 70 mm<sup>2</sup>, CCST AlMgSi, 20(24)kV,  
Equivalent span = 80 m, Stress value in conductor at 0°C = 30N/mm<sup>2</sup>

Cond.-temp	Tensile-force	Sag in meters at a span																	
		10	20	30	40	50	60	70	80	90	100	110	120	130	140	150	160	170	180
50	1277	0,03	0,12	0,27	0,48	0,75	1,08	1,47	<b>1,92</b>	2,43	3,00	3,63	4,33	5,08	5,89	6,76	7,69	8,68	9,73
45	1323	0,03	0,12	0,26	0,46	0,72	1,04	1,42	<b>1,86</b>	2,35	2,90	3,51	4,17	4,90	5,68	6,52	7,42	8,38	9,39
40	1374	0,03	0,11	0,25	0,45	0,70	1,01	1,37	<b>1,79</b>	2,26	2,79	3,38	4,02	4,72	5,47	6,28	7,15	8,07	9,05
35	1430	0,03	0,11	0,24	0,43	0,67	0,97	1,31	<b>1,72</b>	2,17	2,68	3,25	3,86	4,53	5,26	6,03	6,87	7,75	8,69
30	1493	0,03	0,10	0,23	0,41	0,64	0,92	1,26	<b>1,64</b>	2,08	2,57	3,11	3,70	4,34	5,04	5,78	6,58	7,42	8,32
25	1564	0,02	0,10	0,22	0,39	0,61	0,88	1,20	<b>1,57</b>	1,99	2,45	2,97	3,53	4,15	4,81	5,52	6,28	7,09	7,95
20	1644	0,02	0,09	0,21	0,37	0,58	0,84	1,14	<b>1,49</b>	1,89	2,33	2,82	3,36	3,94	4,57	5,25	5,97	6,74	7,56
15	1735	0,02	0,09	0,20	0,35	0,55	0,80	1,08	<b>1,42</b>	1,79	2,21	2,68	3,18	3,74	4,33	4,98	5,66	6,39	7,17
10	1839	0,02	0,08	0,19	0,33	0,52	0,75	1,02	<b>1,34</b>	1,69	2,09	2,52	3,00	3,53	4,09	4,69	5,34	6,03	6,76
5	1960	0,02	0,08	0,18	0,31	0,49	0,70	0,96	<b>1,25</b>	1,59	1,96	2,37	2,82	3,31	3,84	4,41	5,01	5,66	6,34
0	2100	0,02	0,07	0,16	0,29	0,46	0,66	0,90	<b>1,17</b>	1,48	1,83	2,21	2,63	3,09	3,58	4,11	4,68	5,28	5,92
-5	2263	0,02	0,07	0,15	0,27	0,42	0,61	0,83	<b>1,09</b>	1,37	1,70	2,05	2,44	2,87	3,32	3,82	4,34	4,90	5,49
-10	2453	0,02	0,06	0,14	0,25	0,39	0,56	0,77	<b>1,00</b>	1,27	1,56	1,89	2,25	2,64	3,07	3,52	4,00	4,52	5,07
-15	2674	0,01	0,06	0,13	0,23	0,36	0,52	0,70	<b>0,92</b>	1,16	1,43	1,74	2,07	2,42	2,81	3,23	3,67	4,15	4,65
-20	2930	0,01	0,05	0,12	0,21	0,33	0,47	0,64	<b>0,84</b>	1,06	1,31	1,58	1,89	2,21	2,57	2,95	3,35	3,78	4,24
-25	3223	0,01	0,05	0,11	0,19	0,30	0,43	0,58	<b>0,76</b>	0,96	1,19	1,44	1,71	2,01	2,33	2,68	3,05	3,44	3,86
-30	3552	0,01	0,04	0,10	0,17	0,27	0,39	0,53	<b>0,69</b>	0,87	1,08	1,31	1,56	1,83	2,12	2,43	2,77	3,12	3,50



# Regulation tables

## CCST AAAC 99mm<sup>2</sup>, 20(24)kV

Conductor area = 99mm<sup>2</sup>, CCST AlMgSi, 20(24)kV,

Equivalent span = 80m, Stress value in conductor at 0°C = 30N/mm<sup>2</sup>

Cond.-temp	Tensile-force	Sag in meters at a span																	
		10	20	30	40	50	60	70	80	90	100	110	120	130	140	150	160	170	180
50	1645	0,03	0,11	0,25	0,45	0,71	1,02	1,38	<b>1,81</b>	2,29	2,83	3,42	4,07	4,78	5,54	6,36	7,23	8,17	9,16
45	1712	0,03	0,11	0,24	0,43	0,68	0,98	1,33	<b>1,74</b>	2,20	2,72	3,29	3,91	4,59	5,32	6,11	6,95	7,85	8,80
40	1787	0,03	0,10	0,23	0,42	0,65	0,94	1,27	<b>1,66</b>	2,11	2,60	3,15	3,75	4,40	5,10	5,85	6,66	7,52	8,43
35	1872	0,02	0,10	0,22	0,40	0,62	0,89	1,22	<b>1,59</b>	2,01	2,48	3,01	3,58	4,20	4,87	5,59	6,36	7,18	8,05
30	1968	0,02	0,09	0,21	0,38	0,59	0,85	1,16	<b>1,51</b>	1,91	2,36	2,86	3,40	3,99	4,63	5,32	6,05	6,83	7,66
25	2078	0,02	0,09	0,20	0,36	0,56	0,81	1,10	<b>1,43</b>	1,81	2,24	2,71	3,22	3,78	4,39	5,03	5,73	6,47	7,25
20	2204	0,02	0,08	0,19	0,34	0,53	0,76	1,03	<b>1,35</b>	1,71	2,11	2,55	3,04	3,56	4,13	4,75	5,40	6,10	6,83
15	2351	0,02	0,08	0,18	0,32	0,49	0,71	0,97	<b>1,27</b>	1,60	1,98	2,39	2,85	3,34	3,88	4,45	5,06	5,72	6,41
10	2524	0,02	0,07	0,17	0,29	0,46	0,66	0,90	<b>1,18</b>	1,49	1,84	2,23	2,65	3,11	3,61	4,14	4,72	5,32	5,97
5	2728	0,02	0,07	0,15	0,27	0,43	0,61	0,84	<b>1,09</b>	1,38	1,70	2,06	2,45	2,88	3,34	3,83	4,36	4,93	5,52
0	2970	0,02	0,06	0,14	0,25	0,39	0,56	0,77	<b>1,00</b>	1,27	1,57	1,89	2,25	2,65	3,07	3,52	4,01	4,52	5,07
-5	3257	0,01	0,06	0,13	0,23	0,36	0,51	0,70	<b>0,91</b>	1,16	1,43	1,73	2,06	2,41	2,80	3,21	3,65	4,13	4,63
-10	3594	0,01	0,05	0,12	0,21	0,32	0,47	0,63	<b>0,83</b>	1,05	1,29	1,57	1,86	2,19	2,54	2,91	3,31	3,74	4,19
-15	3989	0,01	0,05	0,10	0,19	0,29	0,42	0,57	<b>0,75</b>	0,94	1,17	1,41	1,68	1,97	2,28	2,62	2,98	3,37	3,78
-20	4442	0,01	0,04	0,09	0,17	0,26	0,38	0,51	<b>0,67</b>	0,85	1,05	1,27	1,51	1,77	2,05	2,36	2,68	3,03	3,39
-25	4948	0,01	0,04	0,08	0,15	0,23	0,34	0,46	<b>0,60</b>	0,76	0,94	1,14	1,35	1,59	1,84	2,11	2,41	2,72	3,04
-30	5502	0,01	0,03	0,08	0,14	0,21	0,30	0,41	<b>0,54</b>	0,68	0,85	1,02	1,22	1,43	1,66	1,90	2,16	2,44	2,74

## CCST AAAC 120mm<sup>2</sup>, 20(24)kV

Conductor area = 120mm<sup>2</sup>, CCST AlMgSi, 20(24)kV,

Equivalent span = 80m, Stress value in conductor at 0°C = 30N/mm<sup>2</sup>

Cond.-temp	Tensile-force	Sag in meters at a span																	
		10	20	30	40	50	60	70	80	90	100	110	120	130	140	150	160	170	180
50	2071	0,03	0,12	0,26	0,46	0,72	1,04	1,42	<b>1,85</b>	2,34	2,89	3,50	4,16	4,89	5,67	6,50	7,40	8,35	9,37
45	2151	0,03	0,11	0,25	0,45	0,70	1,00	1,36	<b>1,78</b>	2,25	2,78	3,37	4,01	4,70	5,45	6,26	7,12	8,04	9,02
40	2241	0,03	0,11	0,24	0,43	0,67	0,96	1,31	<b>1,71</b>	2,16	2,67	3,23	3,85	4,51	5,24	6,01	6,84	7,72	8,65
35	2341	0,03	0,10	0,23	0,41	0,64	0,92	1,25	<b>1,64</b>	2,07	2,56	3,09	3,68	4,32	5,01	5,75	6,55	7,39	8,29
30	2455	0,02	0,10	0,22	0,39	0,61	0,88	1,19	<b>1,56</b>	1,98	2,44	2,95	3,51	4,12	4,78	5,49	6,24	7,05	7,90
25	2583	0,02	0,09	0,21	0,37	0,58	0,83	1,14	<b>1,48</b>	1,88	2,32	2,80	3,34	3,92	4,54	5,21	5,93	6,70	7,51
20	2730	0,02	0,09	0,20	0,35	0,55	0,79	1,07	<b>1,40</b>	1,78	2,19	2,65	3,16	3,71	4,30	4,93	5,61	6,34	7,11
15	2900	0,02	0,08	0,19	0,33	0,52	0,74	1,01	<b>1,32</b>	1,67	2,06	2,50	2,97	3,49	4,05	4,64	5,28	5,97	6,69
10	3097	0,02	0,08	0,17	0,31	0,48	0,70	0,95	<b>1,24</b>	1,57	1,93	2,34	2,78	3,27	3,79	4,35	4,95	5,59	6,26
5	3328	0,02	0,07	0,16	0,29	0,45	0,65	0,88	<b>1,15</b>	1,46	1,80	2,18	2,59	3,04	3,53	4,05	4,60	5,20	5,83
0	3600	0,02	0,07	0,15	0,27	0,42	0,60	0,81	<b>1,06</b>	1,35	1,66	2,01	2,40	2,81	3,26	3,74	4,26	4,81	5,39
-5	3920	0,02	0,06	0,14	0,24	0,38	0,55	0,75	<b>0,98</b>	1,24	1,53	1,85	2,20	2,58	2,99	3,44	3,91	4,41	4,95
-10	4297	0,01	0,06	0,13	0,22	0,35	0,50	0,68	<b>0,89</b>	1,13	1,39	1,69	2,01	2,35	2,73	3,14	3,57	4,03	4,51
-15	4736	0,01	0,05	0,11	0,20	0,32	0,46	0,62	<b>0,81</b>	1,02	1,26	1,53	1,82	2,14	2,48	2,84	3,24	3,65	4,10
-20	5242	0,01	0,05	0,10	0,18	0,29	0,41	0,56	<b>0,73</b>	0,93	1,14	1,38	1,64	1,93	2,24	2,57	2,92	3,30	3,70
-25	5814	0,01	0,04	0,09	0,16	0,26	0,37	0,50	<b>0,66</b>	0,83	1,03	1,25	1,48	1,74	2,02	2,32	2,64	2,98	3,34
-30	6447	0,01	0,04	0,08	0,15	0,23	0,33	0,46	<b>0,59</b>	0,75	0,93	1,12	1,34	1,57	1,82	2,09	2,38	2,68	3,01

# Regulation tables

## CCST AAAC 159mm<sup>2</sup>, 20(24)kV

Conductor area = 159mm<sup>2</sup>, CCST AlMgSi, 20(24)kV,  
Equivalent span = 80m, Stress value in conductor at 0°C = 30N/mm<sup>2</sup>

Cond.-temp	Tensile-force	Sag in meters at a span																	
		N	10	20	30	40	50	60	70	80	90	100	110	120	130	140	150	160	170
50	2548	0,03	0,11	0,25	0,44	0,69	1,00	1,36	<b>1,77</b>	2,24	2,77	3,35	3,98	4,68	5,42	6,23	7,08	8,00	8,96
45	2654	0,03	0,11	0,24	0,42	0,66	0,96	1,30	<b>1,70</b>	2,15	2,66	3,21	3,82	4,49	5,20	5,97	6,80	7,67	8,60
40	2775	0,03	0,10	0,23	0,41	0,63	0,91	1,24	<b>1,63</b>	2,06	2,54	3,07	3,66	4,29	4,98	5,71	6,50	7,34	8,23
35	2912	0,02	0,10	0,22	0,39	0,61	0,87	1,19	<b>1,55</b>	1,96	2,42	2,93	3,49	4,09	4,74	5,45	6,20	7,00	7,84
30	3067	0,02	0,09	0,21	0,37	0,57	0,83	1,13	<b>1,47</b>	1,86	2,30	2,78	3,31	3,88	4,50	5,17	5,88	6,64	7,45
25	3246	0,02	0,09	0,20	0,35	0,54	0,78	1,06	<b>1,39</b>	1,76	2,17	2,63	3,13	3,67	4,26	4,89	5,56	6,28	7,04
20	3454	0,02	0,08	0,18	0,33	0,51	0,73	1,00	<b>1,31</b>	1,65	2,04	2,47	2,94	3,45	4,00	4,59	5,23	5,90	6,61
15	3694	0,02	0,08	0,17	0,31	0,48	0,69	0,94	<b>1,22</b>	1,55	1,91	2,31	2,75	3,23	3,74	4,29	4,89	5,52	6,18
10	3978	0,02	0,07	0,16	0,28	0,44	0,64	0,87	<b>1,13</b>	1,44	1,77	2,14	2,55	2,99	3,47	3,99	4,54	5,12	5,74
5	4312	0,02	0,07	0,15	0,26	0,41	0,59	0,80	<b>1,05</b>	1,32	1,63	1,98	2,35	2,76	3,20	3,68	4,18	4,72	5,30
0	4710	0,01	0,06	0,13	0,24	0,37	0,54	0,73	<b>0,96</b>	1,21	1,50	1,81	2,16	2,53	2,93	3,37	3,83	4,33	4,85
-5	5177	0,01	0,05	0,12	0,22	0,34	0,49	0,67	<b>0,87</b>	1,10	1,36	1,65	1,96	2,30	2,67	3,06	3,49	3,93	4,41
-10	5727	0,01	0,05	0,11	0,20	0,31	0,44	0,60	<b>0,79</b>	1,00	1,23	1,49	1,77	2,08	2,41	2,77	3,15	3,56	3,99
-15	6360	0,01	0,04	0,10	0,18	0,28	0,40	0,54	<b>0,71</b>	0,90	1,11	1,34	1,60	1,87	2,17	2,49	2,84	3,20	3,59
-20	7075	0,01	0,04	0,09	0,16	0,25	0,36	0,49	<b>0,64</b>	0,81	1,00	1,21	1,43	1,68	1,95	2,24	2,55	2,88	3,23
-25	7867	0,01	0,04	0,08	0,14	0,22	0,32	0,44	<b>0,57</b>	0,73	0,90	1,08	1,29	1,51	1,76	2,02	2,29	2,59	2,90
-30	8722	0,01	0,03	0,07	0,13	0,20	0,29	0,40	<b>0,52</b>	0,65	0,81	0,98	1,16	1,37	1,58	1,82	2,07	2,34	2,62

## CCST AAAC 241mm<sup>2</sup>, 20(24)kV

Conductor area = 241 mm<sup>2</sup>, CCST AlMgSi, 20(24)kV,  
Equivalent span = 80 m, Stress value in conductor at 0°C = 30N/mm<sup>2</sup>

Cond.-temp	Tensile-force	Sag in meters at a span																	
		N	10	20	30	40	50	60	70	80	90	100	110	120	130	140	150	160	170
50	3754	0,03	0,11	0,24	0,43	0,68	0,97	1,33	<b>1,73</b>	2,19	2,71	3,27	3,90	4,57	5,30	6,09	6,93	7,82	8,77
45	3921	0,03	0,10	0,23	0,41	0,65	0,93	1,27	<b>1,66</b>	2,10	2,59	3,14	3,73	4,38	5,08	5,83	6,63	7,49	8,40
40	4106	0,02	0,10	0,22	0,40	0,62	0,89	1,21	<b>1,58</b>	2,00	2,47	2,99	3,56	4,18	4,85	5,57	6,34	7,15	8,02
35	4321	0,02	0,09	0,21	0,38	0,59	0,85	1,15	<b>1,51</b>	1,90	2,35	2,85	3,39	3,97	4,61	5,29	6,02	6,80	7,62
30	4564	0,02	0,09	0,20	0,36	0,56	0,80	1,09	<b>1,42</b>	1,80	2,23	2,69	3,21	3,76	4,36	5,01	5,70	6,43	7,21
25	4846	0,02	0,08	0,19	0,34	0,52	0,75	1,03	<b>1,34</b>	1,70	2,10	2,54	3,02	3,54	4,11	4,72	5,37	6,06	6,79
20	5176	0,02	0,08	0,18	0,31	0,49	0,71	0,96	<b>1,26</b>	1,59	1,96	2,38	2,83	3,32	3,85	4,42	5,03	5,67	6,36
15	5564	0,02	0,07	0,16	0,29	0,46	0,66	0,89	<b>1,17</b>	1,48	1,83	2,21	2,63	3,09	3,58	4,11	4,68	5,28	5,92
10	6027	0,02	0,07	0,15	0,27	0,42	0,61	0,83	<b>1,08</b>	1,37	1,69	2,04	2,43	2,85	3,30	3,79	4,32	4,87	5,46
5	6574	0,02	0,06	0,14	0,25	0,39	0,56	0,76	<b>0,99</b>	1,25	1,55	1,87	2,23	2,61	3,03	3,48	3,96	4,47	5,01
0	7230	0,01	0,06	0,13	0,22	0,35	0,51	0,69	<b>0,90</b>	1,14	1,41	1,70	2,02	2,38	2,75	3,16	3,60	4,06	4,55
-5	8006	0,01	0,05	0,11	0,20	0,32	0,46	0,62	<b>0,81</b>	1,03	1,27	1,54	1,83	2,15	2,49	2,86	3,25	3,67	4,11
-10	8914	0,01	0,05	0,10	0,18	0,28	0,41	0,56	<b>0,73</b>	0,92	1,14	1,38	1,64	1,93	2,23	2,56	2,92	3,29	3,69
-15	9958	0,01	0,04	0,09	0,16	0,26	0,37	0,50	<b>0,65</b>	0,83	1,02	1,23	1,47	1,72	2,00	2,30	2,61	2,95	3,31
-20	11126	0,01	0,04	0,08	0,15	0,23	0,33	0,45	<b>0,58</b>	0,74	0,91	1,11	1,32	1,54	1,79	2,05	2,34	2,64	2,96
-25	12409	0,01	0,03	0,07	0,13	0,20	0,29	0,40	<b>0,52</b>	0,66	0,82	0,99	1,18	1,38	1,61	1,84	2,10	2,37	2,65
-30	13780	0,01	0,03	0,07	0,12	0,18	0,27	0,36	<b>0,47</b>	0,60	0,74	0,89	1,06	1,25	1,45	1,66	1,89	2,13	2,39



# Product information

## Full Covered Conductor Solution

### Composite insulators

#### Composite tension insulator

Insulator for terminal and intermediate poles of 24-36kV lines. Ideal for 24kV lines in areas of pollution class II & class III (IEC 60815).

Product code	GTIN	End fittings	Creepage distance mm	SMFL kN	Weight kg	Pack. pcs
SDI90.280	6418677422768	Eye-eye	613	70	1,08	3



#### Composite suspension insulator

Composite line post Insulator 24kV with pin M20x140.

Product code	GTIN	Neck dia. mm	Creepage distance mm	SMFL kN	Weight kg	Pack. pcs
SDI82.1M20	6438100316013	73	561	12,5	2,56	1



### Tension & suspension clamps

#### Tension clamps

For dead-ending covered conductors. The clamp is very easy to install compared with the other clamps on the market as there is no need to peel the conductor. The insulation piercing part of the clamp keeps the parts of the clamp at the same potential and prevents partial discharges and radio disturbances. The insulation piercing part also makes it possible to add an arc protection device to the clamp

Product code	GTIN	Conductor range mm <sup>2</sup>	Conductor dia. mm	SMFL kN	Weight kg	Pack. pcs
SO255S	6438100324667	50 - 70	12,7 - 16,7	20	1,133	9
SO256S	6438100324872	95 - 157	16,1 - 22,3	25	2,53	3
SO257S	6438100332129	150 - 241	18,0 - 30,0	60	2,45	3



#### Suspension clamps

Suspension clamp with pulley for covered conductors PAS/BLL AlMgSi. The clamp also functions as an installation pulley thereby completely eliminating the need for separate pulleys.

Product code	GTIN	Conductor range mm <sup>2</sup>	Conductor dia. mm	SMFL kN	Weight kg	Pack. pcs
SO181.6S	6438100324841	50 - 157	12,7 - 22,3	30	1,224	3
SO183S	6438100332112	150 - 241	18,0 - 30,0	60	2	3



# Product information

## Full Covered Conductor Solution

### Connectors

#### Insulation piercing connector

The watertight shear head bolt connector is for Medium Voltage Covered Conductors (MV CC) non-tension aluminium to aluminium connections without peeling the insulation. The nominal insulation thickness of the conductor can be between 2.3-4.0mm.

Product code	GTIN	Conductor range mm <sup>2</sup>	Conductor dia. mm	Tightening torque Nm	Weight kg	Pack. pcs
SLW26	6438100309053	50 - 157	11,5 - 22,5	35 ± 2	0,286	24
SLW27	6438100320065	95 - 241	16,0 - 26,5	35 ± 2	0,286	24



#### Earth parking devices

The SEW's are used for temporary earthing for Medium Voltage Covered Conductors (MV CC). The connector is watertight by silicone greased teeth. The nominal insulation thickness of the conductor can be between 2.3-4.0mm.

Product code	GTIN	Conductor range mm <sup>2</sup>	Conductor dia. mm	Tightening torque Nm	Weight kg	Pack. pcs
SEW30	6438100320072	50 - 157	11,5 - 22,5	35 ± 2	1,093	6
SEW31	6438100320089	150 - 241	18,0 - 26,5	35 ± 2	1,093	6



### Helical Ties

#### For covered conductors, one bag contains six ties

Used with covered conductors for tying the conductors to the insulators. Can be used as both top and side ties. Easy to install without tools. The tie is installed on the insulation of the covered conductor.

Product code	GTIN	Conductor range mm <sup>2</sup>	Colour code	Insulator neck mm	Weight kg	Pack. pcs
SO216.62	6418677404566	50 - 62	White	73 - 85	0,63	25
SO216.99	6418677404573	70 - 120	Red	73 - 85	0,687	25
SO216.157	6418677404542	157	Blue	73 - 85	0,801	25
SO216.24173	6438100312602	241	Yellow-green	73	0,92	25



# Product information

## Full Covered Conductor Solution

### Power arc devices

#### For line post insulators

Arc protection device for covered conductors with line post insulators. The spark gap is adjustable. Short circuit current: Arc test 10kA/1 s.

Product code	GTIN	Conductor range mm <sup>2</sup>	Arc gap length at 24 kV	Weight kg	Pack. pcs
SDI24	6438100319403	50 - 157	130 - 150	1,96	3
SDI29	6438100319410	150 - 241	130 - 150	1,96	3

#### For tension insulators

Power arc device SDI27.1 is used with composite tension insulators.

Product code	GTIN	Conductor range mm <sup>2</sup>	Arc gap length at 24 kV	Weight kg	Pack. pcs
SDI27.1	6418677419133	50 - 241	130 - 150	0,83	9

### Current limiting devices

#### For line post insulators

Used on straight line crossarms with post line insulators for arc protection. The set includes a surge arrester, a fixing bracket, a connector, a spark horn/an arc protection horn. Three sets are needed for one crossarm.

Product code	GTIN	Conductor range mm <sup>2</sup>	Arc gap length at 24 kV	Weight kg	Pack. pcs
SDI48.5	6438100324926	50 - 157	70 - 80	5,18	3
SDI48.6	6438100324940	150 - 241	70 - 80	5,18	3

#### For tension insulators

Used on crossarms with tension insulators for arc protection. The product includes a surge arrester, an tension insulator and spark horn. Three sets are needed for one crossarm.

Product code	GTIN	Conductor range mm <sup>2</sup>	Arc gap length at 24 kV	Weight kg	Pack. pcs
SDI46.824	6438100312138	50 - 241	70 - 80	7,905	1
SDP5	6418677419164	-	-	0,28	30





# Product information

## Full Covered Conductor Solution

### Wildlife protection

#### Weather and UV resistant plastic

The products are manufactured of weather and UV resistant thermoplastic material. The bird protectors protect birds and other animals from accidents and reduce the number of faults and damages in the covered conductor network. A wildlife protection set includes covers for three phases.

Product code	GTIN	Compatible with	Weight kg	Pack. pcs
SP63.3	6438100305826	SO255S	0,891	2
SP67.3	6438100322946	SO256S	1,392	1
SP62.3	6438100301163	SO181.6S	0,45	1

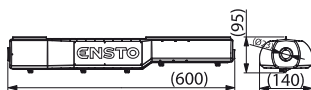

SP63.3



SP67.3

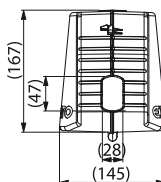

SP62.3

# CIL10X series

Automatic wedge joints with hybrid technology

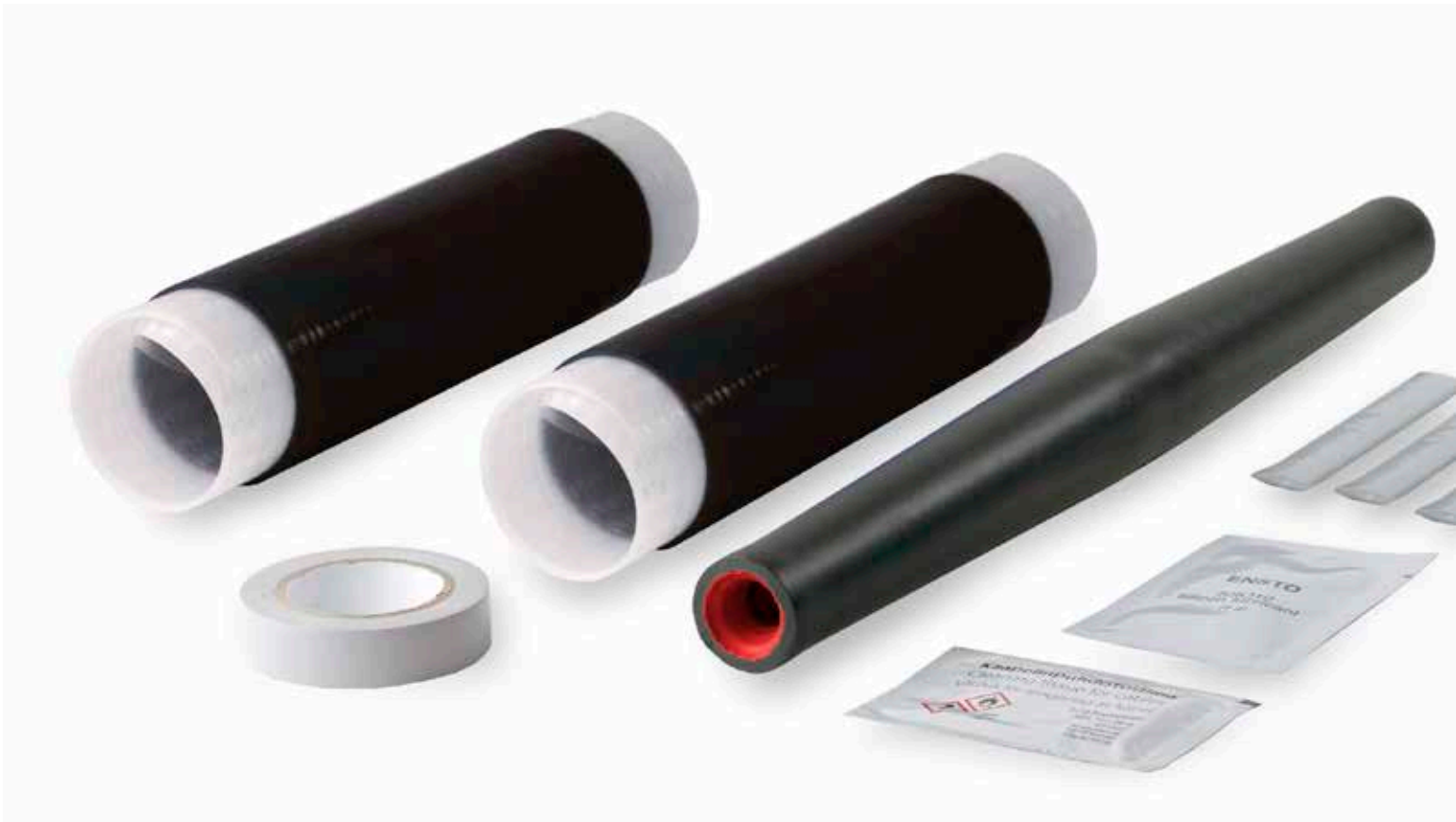

CIL10X automatic joints are easy and quick to make. Special tools are not needed for the installation and the assembly of the joint is faster, easier and safer without flame.

Lifting the hot work gear up with the installer has just become unnecessary - thanks to Ensto's all-new CIL10x series automatic wedge joints with cold shrink sealing tubes.

The automatic joints are easy, quick and safe to install and they don't require any special installation tools. All the CIL10x

series joints have been tested according to the EN50397-2 standard. For installation video and more information visit [www.ensto.com/forgettheflame](http://www.ensto.com/forgettheflame). You can also scan the QR code to access the site directly.



Product code	GTIN	Conductor range mm <sup>2</sup>	Conductor dia. mm	Covered dia. mm	Weight kg	Pack. pcs
CIL106	6438100320621	35 - 50	5,8 - 8,6	11,0 - 15,0	0,6	12
CIL107	6438100320225	50 - 95	9,2 - 12,0	14,0 - 18,0	0,78	12
CIL108	6438100320607	99 - 150	12,8 - 14,9	17,5 - 22,0	1,015	12
CIL109	6438100320614	157	14,7 - 18,4	20,0 - 25,0	1,42	12
CIL110	6438100327330	241	18,8 - 21,7	25,0 - 30,0	1,95	12

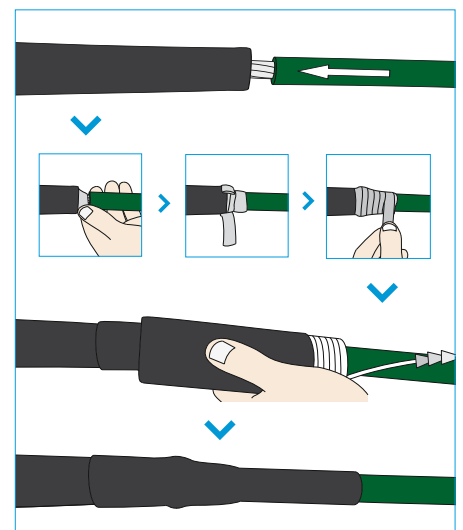

# Overhead Line solutions

## Products and installation instructions

A well designed overhead line networks guarantees uninterrupted electricity distribution. The Ensto Pro training academy provides professionals a comprehensive range of both theory based information and practical installation work.

You can find also good product information and installation instructions from Ensto web sites.

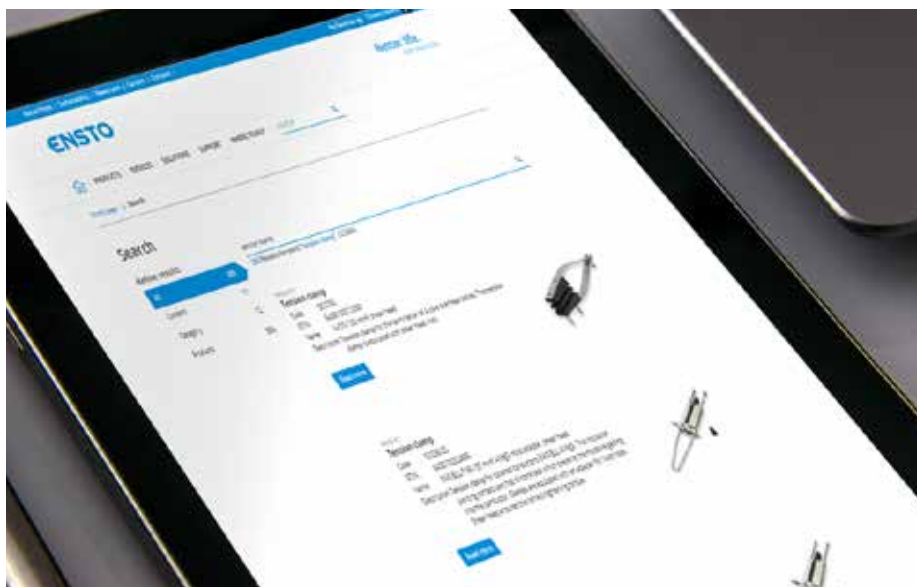

### Product information with you everywhere and on any device

Ensto web site includes thorough information about our solutions and detailed data on our products. The product data includes product cards and specifications for individual products.



### Installation videos

Installation videos and animations help in installing our products as smooth and easy as possible – where ever, when ever.

- The videos can be found on our YouTube channel "EnstoGroup". Scan the QR code to access them directly.



Covered Conductor line under construction.

# Memo





# ENSTO

Ensto Finland Oy  
Ensio Miettisen katu 2, P.O. Box 77  
FIN-06101 Porvoo, Finland  
utility.networks@ensto.com

[ensto.com](http://ensto.com)

