

VBS | Luettelo 2010/2011



Liitäntä- ja kiinnitystarvikkeet

Tervetuloa asiakaspalveluun

Palvelunumero: 0207 417 500

Fax 0207 417 501

info@obo.fi

www.obo.fi



Käytä suoraa yhteyttä OBO:n asiakaspalveluun! Tukipalvelunumerossa 0207 417 500 olemme päivittäin klo 8-16 käytettävissäsi ja vastaamme kaikkiin OBO:n kokonaisvalikoimaa koskeviin kysymyksiin. OBO:n asiakaspalveluun kuuluu:

- Asiantunteva yhteyshenkilö alueellasi
- Kaikki OBO:n tuotevalikoimia koskevat tiedot
- Asiantunteva neuvonta erityisaiheista
- Nopea ja suora pääsy OBO-tuotteiden kaikkiin tietoihin. Haluamme olla parhaita myös asiakaslähtöisyydessämme.

Sisältö

	Suunnitteluohje	5
	Jakorasiat ja tarvikkeet	163
	Uppoasennettavat rasiat ja levyseinärsiat	187
	KytKentätarvikkeet	199
	Holkkitiivisteet, muovi	205
	Holkkitiivisteet, messinki	235
	Kaapeli- ja putkikiinnikkeet - muovi	257
	Kaapeli- ja putkikiinnikkeet - metalli	275
	Muut kiinnitystarvikkeet	293
	Asennusputket ja putkitustarvikkeet	303
	Palkkiinnikkeet	315
	Asennuskiskot	327
	Kaarikiinnikkeet	353
	Kiinnitystarvikkeet - naulat, ruuvit ja ankkurit	377
	Sisällysluettelot	395



OBO VBS-seminaari: Ensikäden tietoa

OBO tukee käyttäjiä laajalla koulutus- ja seminaariohjelmalla, jolla välitetään ensikäden tietoa liitännä- ja kiinnitystarvikkeista Teoreettisten perusteiden lisäksi käsitellään jokapäiväisiä käytännön sovelluksia. Laaja-alaista tiedonvälitystä täydennetään sovellus- ja laskentaesimerkeillä.

Tarjoustekstit, tuotetiedot ja tietolehdet.

Helpotamme työtänne laajalla valikoimalla käytännön tarpeisiin muokattuja materiaaleja, jotka tukevat jo alkuvaiheessa esimerkiksi projektin suunnittelua ja laskentaa. Niihin kuuluvat:

- Tarjousteksti
- Tuotetiedot
- Ohjelehdet
- Tietosivut

Pidämme nämä asiakirjat päivitysten avulla ajantasalla ja ne voidaan ladata maksutta mihin vuorokauden aikaan tahansa Internetistä osoitteessa www.obo.de kohdasta tiedostojen lataukset.

Tarjoustekstit Internetissä osoitteessa www.ausschreiben.de

Maksuton pääsy yli 10.000 tietueeseen valikoimista KTS, BSS, TBS, LFS, EGS ja UFS. Laaja-alainen valikoimakatsaus OBO-tuotteista säännöllisesti päivitettyinä ja täydennettyinä. Kaikki tavalliset tiedostomuodot ovat käytettävissä (pdf, doc, gaeb, html, text, xml, önorm). www.ausschreiben.de

Suunnittelu- ja asennusohje

	Yleinen suunnitteluohje	6
	Jakorasiat ja tarvikkeet	23
	Uppoasennettavat rasiat ja levyseinärasiat	49
	KytKentätarvikkeet	57
	Holkkitiivisteet	63
	Kaapeli- ja putkikiinnikkeet - muovi	73
	Kaapeli- ja putkikiinnikkeet - metalli	91
	Muut kiinnitystarvikkeet	103
	Asennusputket ja putkitustarvikkeet	113
	Palkkiikiinnikkeet	121
	Asennuskiskot	127
	Kaarikiinnikkeet	135
	Kiinnitystarvikkeet - naulat, ruuvit ja ankkurit	141
	Lisätietoja	152



Pinnat ja käyttöalueet



Pinnat/käyttöalueet:

Kaikkilla asennuksilla ja tarvikkeilla pitää olla riittävä korroosionkestävyys. Tällöin erotellaan eri menetelmät ja materiaalit, jotka soveltuvat ominaisuuksiensa perusteella joko hyvin tai tyydyttävästi käyttöalueelle. Alla esitellään eri käyttöalueet ja niille suositellut materiaalit. Taulukossa kuvataan käyttöalue ja odotettavissa oleva sinkin kuluminen DIN EN ISO 12944 mukaan.

Käyttöalue - sisätilat

Sisätiloihin tehtäviä asennuksia varten OBO tarjoaa galvaanisesti sinkittyjä tai kuumasinkittyjä tuotteita. Ne sopivat erityisesti kuiviin sisätiloihin, joissa on huoneilma, eikä syövyttäviä haitta-aineita.

Galvaaninen sinkitys

- Elektrolyttinen sinkitys standardin DIN EN 12329 mukaan.
- Kalvon paksuus keskimäärin noin 2,5 - 10 µm
- Direktiivin RoHS mukaan

Kuumasinkitys

- Kuumasinkitys kuumasinkitysmenetelmän DIN EN 10327 (aiemmin DIN EN 10147 ja DIN EN 10142) mukaan.
- Kalvon paksuus keskimäärin noin 20 µm
- Levyjen katkaisukohtat suojataan katodisella korroosiosuojauksella materiaalin vahvuuteen 2,0 mm:ä asti.



Yleinen suunnitteluohje pinnoista ja käyttöalueista



Käyttöalue - ulkotilat

Ulos, kosteisiin tiloihin tai syövyttävään ympäristöihin tehtäviä asennuksia varten OBolla on tuotteita, jotka on kuumasinkitty upottamalla tai valmistettu ruostumattomasta teräksestä.

Kuumasinkitys upottamalla

- Kuumasinkitys upotusmenetelmällä DIN EN ISO 1461 mukaan.
- Kalvon paksuus DIN EN ISO 1461 mukaan noin 40 - 60 µm
- Jälkikäteen tehdyt leikkauskohdat pitää sinkitä korroosiolta suojaamiseksi.

V2A ruostumaton teräs

- OBO-lyhenne: V2A
- Eurooppalainen raaka-ainenumero: 1.4301
- Amerikkalainen raaka-ainemerkintä: 304
- Hitsatut rakenneosat passivoidaan.
- Hitsaamattomat rakenneosat huuhdellaan ja niistä poistetaan rasva.

Korroosionkestävyysluokat DIN EN ISO 12944 mukaan

Korroosionkestävyysluokka	Tyypillinen ympäristö sisällä	Tyypillinen ympäristö ulkona	Korroosiorasitus	Sinkin keskimääräinen poistuminen
C 1	Lämpimät rakennukset tavallisella huoneilmalla esim. toimistot, kaupat, koulut, hotellit	-	ei merkittävästi	< 0,1 µm/a
C 2	Kylmät rakennukset, joissa voi ilmetä kondensioivaa esim. varastot, urheiluhallit jne.	Ilmakehä, jossa on vain vähän liקהiukkasia, yleensä maaseutualueet.	vähäinen	0,1 - 0,7 µm/a
C 3	Tuotantotilat, jotka ovat hyvin kosteita ja joiden ilmassa on jonkin verran epäpuhtauksia esim. elintarviketeollisuuslaitokset, pesulat, panimot, meijerit.	Kaupunki- ja teollisuusalueiden ilma-kehä, jonkin verran rikkidioksidin aiheuttamia epäpuhtauksia, rannikkoalueet vähäisillä suolapitoisuuksilla.	kohtuullinen	0,7 - 2,1 µm/a
C 4	Kemialliset laitokset, uima-altaat, merenpinnan yläpuolella olevat venesuojat	Teollisuuskohteet ja rannikkoalueet, joissa suolavesikuormitus on pieni.	voimakas	2,1 - 4,2 µm/a
C 5-I	Rakennukset ja alueet, joissa muodostuu lähes jatkuvasti kondensioivaa ja paljon epäpuhtauksia.	Teollisuuskohteet, joissa on korkea kosteus ja syövyttävä ilmakehä.	erittäin voimakas (teollisuus)	4,2 - 8,4 µm/a
C 5-M	Rakennukset ja alueet, joissa muodostuu lähes jatkuvasti kondensioivaa ja paljon epäpuhtauksia.	Rannikko- ja merialueiden suolarasitus	erittäin voimakas (meri)	> 4,2 - 8,4 µm/a



UV- ja säänkestävyys



Suojattu ja suojaamaton ulkoasennus

Ulkoasennuksissa pitää asennuspaikka ja asennettavat materiaalit valita aina hyvin harkitusti. Tuotteita valitessa on etukäteen otettava huomioon ympäristöolosuhteet ja ympäristövaikutukset.

UV- ja säänkestävyys ulkoasennuksissa

UV- säteilyn lisäksi on ulkoasennuksissa otettava huomioon myös muut ympäristövaikutukset ja ne on selvitettävä tarkkaan. Vaikuttavia tekijöitä ovat maksimilämpötilat, suurten lämpötilanmuutosten yleisyys, ilmankosteus ja myös käyttö-/asennuspaikka (asunnot, teollisuus, kaupunki, seutu, manner). Ongelmallista on, että asennusmateriaalien säänkestävyydelle erilaisissa ympäristöolosuhteissa ei ole olemassa standardisoitua tarkastusmenetelmää. Sen vuoksi pitää tarkastella erikseen ulkoasennuksia jätteenkeräyspaikkojen, kemiallisten ja petrokemiallisten laitojen sekä puhdistuslaitosten jne. läheisyydessä.

Räjähdyssuojatut tuotteet



Euroopan talousalueella saa 01.07.2003 lähtien ottaa räjähdysvaarallisilla alueilla tarkoituksenmukaiseen käyttöön vain laitteita ja suojajärjestelmiä, jotka ovat EU-direktiivin 94/9/EG mukaisia. Tämä direktiivi on nimeltään ATEX (Atmosphere Explosible – Räjähdyssaltis ilmakehä). Räjähdyssuuralliset alueet jaetaan vyöhykkeisiin. Vyöhykejako on sellaisten ympäristöjen analyysi- ja luokitusmenetelmä, joissa voi syntyä räjähdysherkkiä kaasukehiä tai pöly-/ilma-seoksia. Näin helpotetaan niiden laitteiden valintaa, joita voidaan turvallisesti käyttää tällaisissa ympäristöissä. Vaara-alueet, jotka syntyvät syttyvistä kaasuista, jaetaan vyöhykkeisiin 0, 1 ja 2. Vaara-alueet, jotka syntyvät syttyvistä pölyistä, jaetaan samalla tavoin vyöhykkeisiin 20, 21 ja 22. Vaarallisuus on suurin vyöhykkeillä 0 ja 20 sekä pienin vyöhykkeillä 2 ja 22.





Räjähdyksvaarallisten alueiden vyöhykejako

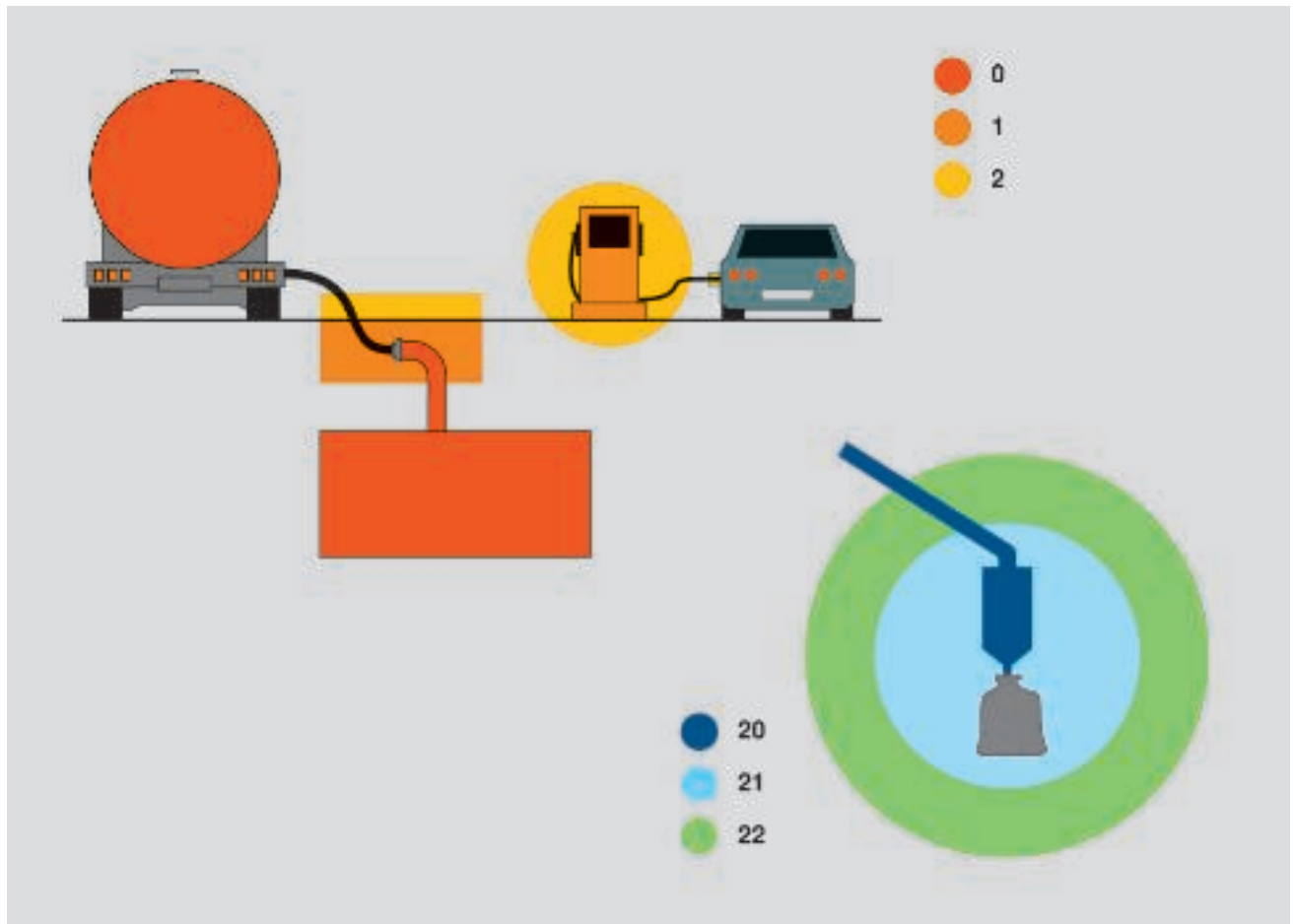

Laiteryhmän II vyöhykejako (maanpäällinen)

Kaasu	Pöly
Räjähdysherkkä kaasukehä, vyöhykejako DIN EN 60079-10 mukaan	Räjähdysherkkä pöly-/ilmaseos, vyöhykejako DIN EN 61214-10 mukaan.
Vyöhyke 0	Vyöhyke 20
Alue, jossa on jatkuvasti tai pitkäaikaisesti tai usein räjähdysherkkä ilmacehä kaasusta.	Alue, jossa on jatkuvasti tai pitkäaikaisesti tai usein räjähdysherkkä ilmacehä pölystä/ilmasta.
Vyöhyke 1	Vyöhyke 21
Alue, jossa on varauduttava siihen, että normaalikäytön aikana muodostuu toisinaan räjähdysherkkä ilmacehä kaasusta.	Alue, jossa on varauduttava siihen, että normaalikäytön aikana muodostuu toisinaan räjähdysherkkä ilmacehä pölystä/ilmasta.
Vyöhyke 2	Vyöhyke 22
Alue, jossa on varauduttava siihen, että normaalikäytön aikana muodostuu harvoin tai lyhytaikaisesti räjähdysherkkä ilmacehä kaasusta.	Alue, jossa on varauduttava siihen, että normaalikäytön aikana muodostuu harvoin tai lyhytaikaisesti räjähdysherkkä ilmacehä pölystä/ilmasta.

Halogeenivapaiden materiaalien merkintä



Halogeenivapaat asennusmateriaalit

Tapahtumat kuten Düsseldorfin lentokenttäpalo, jossa ihmiset kuolivat paksuun savuun, havahtuttivat kiinnittämään huomion toimintojen turvaamisen ja palosuojajärjestelmien lisäksi myös tavallisiin asennusmateriaaleihin. Sen vuoksi halogeenivapaiden tuotteiden kysyntä on kasvanut. Julkisilla alueilla (pelastustiet, hissit jne.) käytetään asennuksissa halogeenivapaita materiaaleja. Halogeenivapaiden materiaalien kemiallinen koostumus on sellainen, että palon sattuessa syntyy vähemmän vahingollisia (myrkyllisiä/syövyttäviä) kaasuja, jotka voivat muuttua sammutusaineiden kanssa suolahapoiksi. Standardin DIN VDE 0472 mukaisesti tämä merkitsee, että materiaali on halogeenivapaa, kun "massaosuudet halogeeneille kloori, bromi ja jodi on laskettu kloorina $\leq 0,2$ % ja fluorille $\leq 0,1$ %". Halogeenivapaita asennusjärjestelmiä ei tosin vaadita tällä hetkellä eh-

dottomasti DIN-VDE-määräyksessä, silti OBO tarjoaa laajan valikoiman halogeenivapaita tuotteita. Niiden avulla voidaan henkilö- ja tavaravahingot minimoida palon sattuessa!





Sähkölaitteiden toimintojen turvaaminen

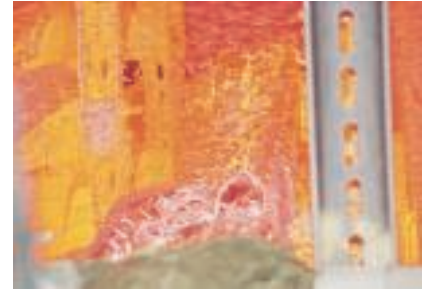
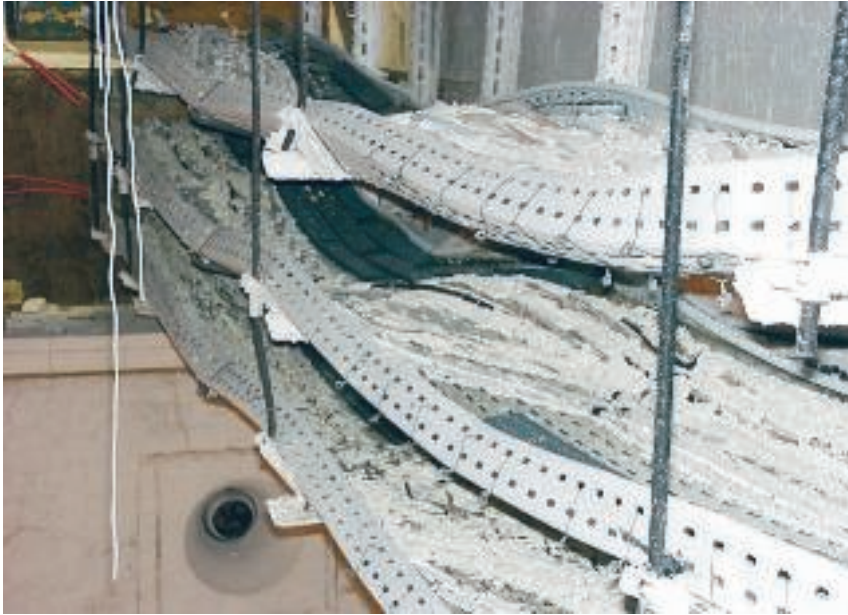

Turvallisuus palon syytyessä

Paljon ihmisiä, paljon turvallisuutta

Toimintojen turvaaminen palonkestävillä johtojärjestelmillä on erityisen tärkeää rakennuksissa, joissa on säännöllisesti paljon ihmisiä. Näihin rakennuksiin kuuluvat julkiset laitokset kuten koulut, sairaalat, kokoustilat, virastot ja metroasemat mutta myös teollisuuslaitokset, kerrostalot, ostoskeskukset ja suuret parkkihallit.

30 minuuttia: Toimintojen säilyttäminen evakuointia varten

Tulipalon syytyessä 30 ensimmäistä minuuttia ovat ratkaisevia rakennuksen evakuoinnille. Tällä aikavälillä pitää toimintojen säilyminen turvata seuraaville laitteistoille.

- Turvavalaistuslaitteet
- Henkilöhissit palo-ohjauksella
- Palohälytyslaitteet
- Laitteistot vierailijoiden ja työntekijöiden hälyttämiseen ja ohjaamiseen palotilanteessa
- Savunpoistolaitteet

90 minuuttia: Toimintojen säilyminen palontorjunnalle

Palontorjunnassa pyritään siihen, että määrätyt tekniset laitteistot saavat vielä riittävästi virtaa rakennuksessa 90 minuutin ajan tulipalon syytymisen jälkeen. Näihin lait-

teisiin kuuluvat:

- Laitteistot vedenpaineen nostamiseksi sammutusvesijärjestelmissä
- Koneelliset savunpoistolaitteet sekä palo- ja savupellit
- Palokunnan hissit, potilashissit sairaaloissa

Erillisasennukset

Erillisasennuksiin suunnitelluilla tuotteilla OBO tarjoaa valikoiman käytännöllisiä ja joustavia tuotteita palonkestäviin sähköasennuksiin, joilta vaaditaan toimintojen turvaamista. Tuotteet sopivat pysty- ja vaakasuoriin asennuksiin ja ne on hyväksytty paloluokkien E30 ja E90 mukaan. Tarkastusstandardissa DIN 4102 osa 12 määritettyihin standardin mukaisiin kantaviin rakenteisiin kuuluvat: kaapelien asennus yksittäiskiinnikkeellä ja kaapelien asennus asennuskiskolla, kaapelikiinnikkeellä sekä pitkällä vanteella.

Asennusjärjestelmien palokuormat

Voimassa olevan standardin MLAR mukaan ei vaadita enää tietoja sähköasennusten palokuormista pako- ja pelastusteille, koska aina vaaditaan palokuorma 0 kWh!



Sähkölaitteiden toimintojen turvaaminen



Säilyttää toiminnot!

Jotta tulipalon sattuessa pako- ja pelastustiet ovat käytettävissä ja tärkeät tekniset laitteistot kuten hätävalaistus, palohälytysjärjestelmät ja savunpoistolaitteet säilyvät toimintakykyisinä, on äärettömän tärkeää, että nämä järjestelmät varmistetaan erikseen. Käyttämällä palonkestäviä johtojärjestelmiä on mahdollista turvata sähkön toimitus myös palon sattuessa ja ylläpitää tärkeät toiminnot. Yksityiskohtaisia tietoja palo-suojauksesta on OBO BBS palo-suojatuotteiden luettelossa.

Standardin mukainen asennustapa kaapelikiinnikkeellä tyyppi 2056

Standardin mukainen asennusrakenne kaapelikiinnikkeellä ilman pitkää vannetta erillisasennuksena tai kaapeleiden niputuksena. Pikainfo:

- Seinä- tai kattoasennus
- Pystysuora tai vaakasuora asennus
- Kiskon asennus: maks. 0,3 m
- Tulppien etäisyys kiskossa: maks. 0,25 m
- Erilliskaapelit: halkaisija 100 mm:iin
- Kaapeliniiput: maks. 3 kaapelia halkaisijalla maks. 25 mm

Standardin mukainen asennustapa kaapelikiinnikkeellä tyyppi 732/733

Standardin mukainen asennusrakenne kaapelikiinnikkeellä erillisasennuksena tai kaapeleiden niputuksena. Pikainfo:

- Seinä- tai kattoasennus
- pystysuora tai vaakasuora asennus
- Asennusetäisyys: maks. 0,3 m
- Erilliskaapelit: halkaisija 50 mm:iin
- Kaapeliniiput: maks. 3 kaapelia halkaisijalla maks. 25 mm

nus kattoon. Pikainfo:

Tyyppi 2033 M

- Kiinnitysetäisyys: maks. 0,5 m

Tyyppi 2034 M

- Kiinnitysetäisyys: maks. 0,5 m

Kaapelin asennustapa kaapelikiinnikkeellä

Kaapelin asennustapa kaapelikiinnikkeellä erillisasennuksena, asennus seinään tai kattoon. Pikainfo: Tyyppi 2031/M 15

- Kiinnitysetäisyys: maks. 0,5 m
- Kaapelit: maks. 1,1 kg/m

Tyyppi 2031/M 30

- Kiinnitysetäisyys: maks. 0,5 m
- Kaapelit: maks. 2,5 kg/m

Tyyppi 2031/M 70

- Kiinnitysetäisyys: maks. 0,8 m
- Kaapelit: maks. 6,0 kg/m

Kaapelin asennustapa kaapelikiinnikkeellä

Kaapelin asennustapa kaapelikiinnikkeellä erillisasennuksena, asen-



Palonpidättävyys/tulenkestävyys

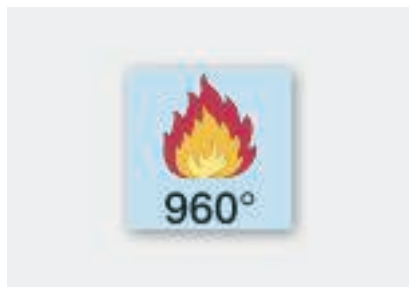
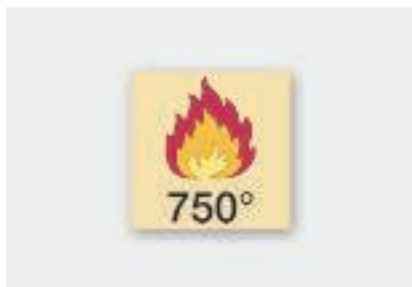

DIN EN 60695-2-11 (VDE 0471 osa 2-11) mukaan sähköliitäntä-materiaaleille on tehtävä hehkulankakoestus, jolla arvioidaan lopputuotteen palovaarallisuus. Standardin mukaisessa merkityksessä lopputuotteita ovat sähkölaitteet sekä rakenneryhvät ja rakenneosat. Hehkulankakoosteessa tarkastettavaan rakenneosaan viedään hehkuva lanka (lämpötila, katso taulukko 1 - Palonpidättävyys) 30 sekunnin ajaksi ja otetaan se sen jälkeen pois. Vähintään 30 seuraavan sekunnin aikana objektin pitää sammua, mikäli se on syttynyt palamaan, jotta itsesammuvuus on turvattu.

Asennustekniikan lajit

Koestuskappaleiden lajit	Pinta-asennus	Uppoa-sennus	Rappauk-sessa	Levyseinä-/kaluste	Betoni-rakenne	Asennus-kanava
	Koestuslämpötilat °C					
Jako- ja liitäntärasiat	650	650	750	850	650	750
Kojerasiat	750	650	-	850	650	750
Kattovalaisimien liitäntä- ja kytkentärasiat	750	650	-	850	650	750
Seinävalaisimien liitäntärasiat	750	650	-	850	650	750
Kojeliitäntärasiat	750	650	-	850	650	750
Liitosholkit	750	-	-	-	-	750
Eristävät osat, jotka on liitetty aktiivisiin osiin	960	-	-	-	-	-
Asennusrasioiden kannet	750	-	-	-	-	-



Tietoja tarkastusmerkeistä



VDE

VDE on sähkötekniikan, elektronikan ja tietotekniikan, niihin liittyvien tieteiden sekä niihin perustuvien teknologioiden ja sovellusten liitto. VDE Tarkastus- ja sertifiointilaitos on kansallisesti ja kansainvälisesti valtuutettu laitos sähkötekniisten laitteiden, komponenttien ja järjestelmien tarkastuksen ja sertifiointin alueilla. Siellä tarkastetaan sähkötuotteiden turvallisuus, sähkömagneettinen yhteensopivuus ja muut tuoteominaisuudet. Tarkastukset ja sertifiointit ovat tärkeitä kuluttajasuojan ja tuotteidemme jakelun ja myynnin kannalta. VDE Tarkastus- ja sertifiointilaitos neutraalina ja riippumattomana laitoksena on maailmanlaajuisesti sähkötekniikan, elektronikan ja tietotekniikan kumppani. Kaikki erilaisten tuoteominaisuuksien merkitykselliset tarkastukset liittyvät VDE:hen

Standardinmukaisuus selvitys

CE-merkintä

Tekniset työvälitteet, jotka määrittellään asetuksissa - kuten sähkölaitteet, koneet ja turvarakennneosat täytyy varustaa CE-merkinnällä, jolla valmistaja vakuuttaa, että lain asettamat turvallisuusmääräykset on täytetty. Lisäksi pitää olla standardinmukaisuus selvitys ja tekniset asiakirjat. CE-merkintä ei ole mikään laatumerkki, vaan valmistajan selvitys siitä, että hän on noudattanut lain asetuksia ja tekniikan sääntöjä.



Tietoja suojaustasoista



IP-suojausluokka

IP-suojausluokalla ilmoitetaan, miten rakenneosia on suojattu ihmiskosketukselta ja vierailta esineiltä sekä vedeltä. IP-suojausluokat on määritelty standardissa DIN EN 60529 (VDE 0470 osa 1). IP-tieto muodostuu aina kahdesta tunnusnumerosta:

- Ensimmäinen numero merkitsee kosketussuojausta ja suojausta vierailta esineiltä. Ensinnä se ilmoittaa, miten kotelo suojaa pääsyn vaarallisiin osiin estämällä tai rajoittamalla käden kosketusta tai kädessä olevien esineiden kosketusta. Toiseksi se ilmoittaa, miten kotelo suojaa vieraiden kiinteiden esineiden tunkeutumisen asennettuihin sähkölaitteisiin.
- Toinen numero merkitsee suojausta vedeltä. Se ilmoittaa, miten sähkölaite on suojattu sisään tunkeutuvilta vedeltä ja sen vahingollisilta vaikutuksilta.

Suojaustaso

Tunnuksen ensimmäinen numero	pääsy vaarallisiin osiin estetty	kiinteiltä, vierailta esineiltä
0	Pääsy vaarallisiin osiin kämmenellä estetty	suojaamaton
1	Pääsy vaarallisiin osiin sormilla estetty	Suojattu kiinteiltä, vierailta esineiltä, joiden halkaisija on 50 mm tai enemmän
2	Pääsy vaarallisiin osiin työkalujen avulla estetty	Suojattu kiinteiltä, vierailta esineiltä, joiden halkaisija on 12,5 mm tai enemmän
3	Pääsy vaarallisiin osiin metallilangalla estetty	Suojattu kiinteiltä, vierailta esineiltä, joiden halkaisija on 2,5 mm tai enemmän
4	Pääsy vaarallisiin osiin metallilangalla estetty	Suojattu kiinteiltä, vierailta esineiltä, joiden halkaisija on 1,0 mm tai enemmän
5	Pääsy vaarallisiin osiin metallilangalla estetty	suojattu pölyltä
6	Pääsy vaarallisiin osiin metallilangalla estetty	pölytiivis



Tietoja suojaustasoista



Suojaustaso veden vahingollista vaikutusta vastaan

Tunnuksen toinen numero	Lyhyt kuvaus	Määritelmä
0	suojaamaton	-
1	Suojattu tippuvalta vedeltä	Pystysuoraan putoavat vesipisarat eivät saa aiheuttaa vahinkoa
2	Suojattu tippuvalta vedeltä, kun kotelo on 15° kaltevassa kulmassa	Pystysuoraan putoavat vesipisarat eivät saa vahingoittaa koteloa, kun kotelo on 15° kaltevassa kulmassa
3	Suojattu suihkuvedeltä	Molemminpuolisesti 60° pystykulmassa suihkuava vesi ei saa vahingoittaa koteloa
4	Suojattu roiskevedeltä	Joka suunnasta voimakkaasti roiskuva vesi ei saa vahingoittaa koteloa
5	Suojattu voimakkaasti ruiskuavalta vedeltä	Joka suunnasta suihkuava vesi ei saa vahingoittaa koteloa
6	Suojattu voimakkaasti ruiskuavalta vedeltä	Joka suunnasta voimakkaasti suihkuva vesi ei saa vahingoittaa koteloa
7	Suojattu ajoittaiselta upotukselta veden alle	Vettä ei saa esiintyä niin paljon, että sillä on vahingollinen vaikutus, kun kotelo on ei-standardin mukaisissa paine- ja aikaolosuhteissa ajoittain upotettuna veden alle
8	Suojattu jatkuvalta upotukselta veden alle	Vettä ei saa esiintyä niin paljon, että sillä on vahingollinen vaikutus, kun kotelo on jatkuvasti upotettuna veden alle ehdoilla, jotka täytyy sopia valmistajan ja käyttäjän välillä. Ehdot on kuitenkin vaikeampi täyttää kuin tunnuksen numerossa 7



Tietoja suojaustasoista



Suojaustaso mekaaniselta kuormitukselta IK-koodi

IK -koodi standardin DIN EN 50102 mukaan merkitsee koteloiden suojaustasoa ulkoiselta mekaaniselta kuormitukselta. Koodi muodostuu koodikirjaimista IK ja kaksinumeroisesta tunnuslukuryhmästä 00-10. Jokainen numeroryhmä merkitsee kuormitusenergia-arvoa jouleina (J). IK-koodi koskee koko koteloa, joka suojaa käyttöosia mekaanisen kuormituksen aiheuttamilta vahingollisilta vaikutuksilta. Koestus suoritetaan siten, että koteloa iskurasitetaan erilaisilla koestusvasaroilla.

Suojausluokat VDE 0140 mukaan Sähkölaitteiden suojausluokat

DIN VDE 0140 määrittää suojausluokat seuraavasti:

- Suojausluokka I: Suojamaadoitetut sähkölaitteet (suojaus suojamaadoituksella kotelossa)
- Suojausluokka II: Sähkölaitteet suojaeristyksellä (suojaus eristyksellä)
- Suojausluokka III: Sähkölaitteet suojaajännitteellä (SELV-PELV, suojaus mitoitusjännitteillä maks. 25/50 V AC ja maks. 60/120 V DC)

Tyhjät muoviset rasiat vastaavat suojausluokkaa II, metallisiin rasioihin ja metallipinnoitettuihin rasioihin täytyy asentaa suojamaadoitus, sen jälkeen ne vastaavat suojausluokkaa I.

IK-koodi	00	01	02	03	04	05	06	07	08	09	10
Kuormitus, energia-arvo [J]	-	015	020	035	0,50	0,70	1	2	5	10	20



Sähkölaitteiden merkintä

Selitykset standardista

Sähkömerkinnät

Kun käytetään jakorasioita ja liittimiä käyttöosat jaotellaan ominaisarvojen mukaan, jotka on määritetty VDE 0100 osan 200 mukaisesti. Merkinnöissä erotellaan sallittu enimmäisjännite (nimellisjännite), sallittu enimmäisvirta (nimellisvirta) ja liitettävien johtojen ja kaapeleiden suurin sallittu poikkileikkausala (nimellispoikkipinta).



Nimellispoikkipinta

Liitettävän johdon suurin tarkastettu, sallittu poikkipinta.



Nimellisvirta

Korkein sallittu virta liitäntäpisteessä.



Nimellisjännite

Liitäntäpisteen korkein sallittu jännite.



Napojen lukumäärä

Liittimen liitäntäpisteiden lukumäärä.



Aihoiden lukumäärä

Aihoiden lukumäärä jakorasiaan tai liitäntärasiaan.



Tärkeitä tietoja ulkohalkaisijoiden määrittämisestä

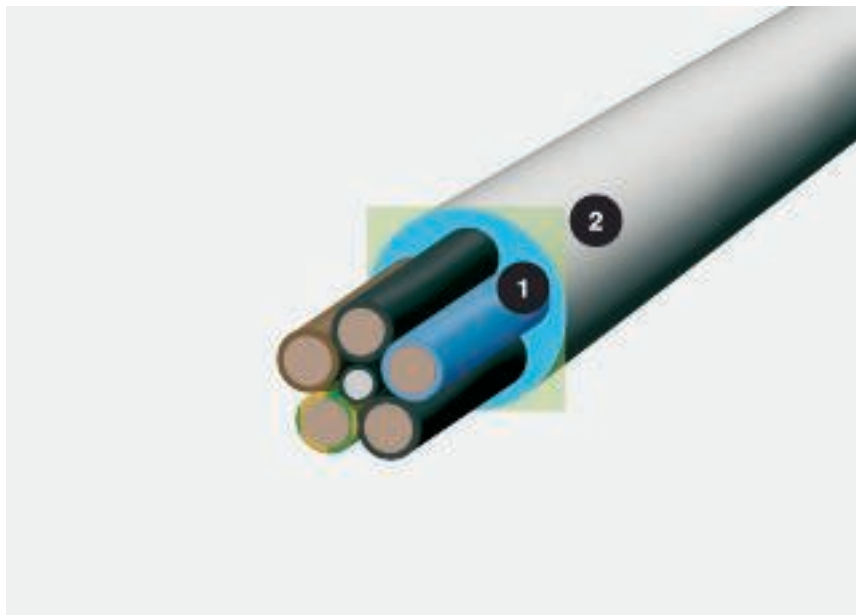

Kaapelin halkaisija ja tilantarve, 1 = halkaisija mm, 2 = tilantarve cm²

Kaapeleiden ulkohalkaisijamitat, PG ja metriset koot

Kaapelilla tarkoitetaan päällystettyä sähköjohtoa, jota käytetään sähköenergian ja tiedonsiirrossa.

Kaapelit ilmoitetaan niiden nimellispoikkipinta-alan mukaan. Nimellispoikkipinta-alan ja yksittäisten kaapelissa olevien johtimien lukumäärän perusteella määritetään kaapelin ulkohalkaisija ja hyötypoikkipinta-ala. Kiinnikkeet ilmoitetaan enimmäiskiinnitysalueella nimelliskokona millimetreissä Kiinnitettävälle rakenneosalle sopivan kiinnikkeen mittojen selvittämiseksi on taulukossa selvitetty PG-mittojen ja metristen mittojen väliset yhteydet.

Laskenta kaavalla $(2r)^2$

Halkaisija ei kerro paljon kaapelin tarvitsemasta todellisesta tilasta. Laske: $(2r)^2$. Tämä arvo ilmaisee todellisen tilantarpeen sisältäen väli-tilat.



Tärkeitä tietoja ulkohalkaisijoiden määrittämisestä

Kaapelin halkaisija ja tilantarve

Ulkohalkaisija mm	PG-mitat	Ulkohalkaisija mm	Metriset mitat
12	PG 7	12,5	M 12
13	PG 7	12,5	M 12
15	PG 9	15,2	M 16
16			M 16
18	PG 11	18,6	M 16/M 20
19	PG 11	18,6	M 16/M 20
20	PG 13,5	20,4	M 20
21	PG 13,5	20,4	M 20/M 25
22	PG 16	22,5	M 20/M 25
23	PG 16	22,5	M 20/M 25
24			M 20/M 25
25			M 25
28	PG 21	28,3	M 25/M 32
32			M 32
37	PG 29	37	M 32/ M40
40			M 40
47	PG 36	47	M 40/M 50
50			M 50
54	PG 42	54	M 50/M 63
59	PG 48	59,3	M 50/M 63
63			M 63





Palkkikiinnikkeiden asennusohje



Palkkikiinnikkeet ovat rakenneosia, joilla voidaan toteuttaa teräspalkkien alapuolisia asennuksia teräs-

runkorakenteissa. Palkkikiinnikkeet voidaan lyödä tai ruuvata palkin laippaan. Lyötävä palkkikiinnike lu-

kittuu metalliin ja ruuvattavassa kiinnikkeessä ruuvi lukitsee palkki-kiinnikkeen metalliin.



Palkkiinnikkeiden asennusohje



Lyötävät palkkiinnikkeet

Palkkiinnikkeet lyödään palkin laippaan ja ne lukittuvat siihen.



Palkkiinnikkeiden ruuviinnitys

Ruuvattavat palkkiinnikkeet kiinnitetään ruuvin avulla palkin laippaan.



Palkkiinnikkeet asennusputkille

Palkkiinnikkeiden käyttö putkiinnityksiin.



Palkkiinnikkeen asennus

Palkkiinnikkeen ja valaisimen ripustusketjun asennus.



Palkkiinnikkeiden asennus

Asennus - palkkiinnikkeet kierteillä ja putkiinnikke 732 kiinnitettynä palkkiinnikkeeseen TK-G.



Palkkiinnikkeen asennus

Palkkiinnikkeen kiinnitys ja kierretankojen kiinnitys jatkomutterilla.



Palkkiinnikkeen asennus

Palkkiinnikkeiden ja asennusputken kiinnitys palkin laipan suuntaisesti.



Palkkiinnikkeen asennus

Palkkiinnikkeiden ja asennusputken kiinnitys laipan suuntaisesti.



Palkkiinnikkeen asennus

Palkkiinnikkeiden ja asennusputken kiinnitys palkin laipan suuntaisesti.



Palkkiinnikkeen asennus tyyppillä 328

Kahden palkkiinnikkeen ja asennuskiskon säädettävä kiinnitys



Palkkiinnikkeet tyyppi 328

Kahden palkkiinnikkeen ja asennuskiskon säädettävä kiinnitys. Näin voidaan toteuttaa asennusrakenteita teräspalkkien alapuolella.



Palkkiinnikkeen asennus

Palkkiinnikkeet voidaan kiinnittää laippaan sekä vaaka- että pystysuoraan.



Palkkiinnikkeiden asennusohje



Käyttö: Palkkiinnikkeet tyyppi 339

Palkkiinnikkeillä tyyppi 339 kiinnitetään asennuskiskot ruuviliitoksilla teräspalkkeihin.



Käyttö: Palkkiinnike tyyppi TKCI

Palkkiinnikettä käytetään, kun asennusputkia tai kaapeleita asennetaan teräspalkkeihin.



Käyttö: Palkkiinnike niveellä

Kun tehdään ripustuksia kalteviin teräsrakenteisiin, voidaan käyttää palkkiinnikkeitä niveellä. Kiinnike kiinnitetään palkkiin ruuvilla.





Käyttö: Profiilikiskon kiinnike

Kiinnityskappaleella TKD ja vastamutterilla TKD G voidaan kannattimia kiinnittää helposti katoprofiilikiskoihin.

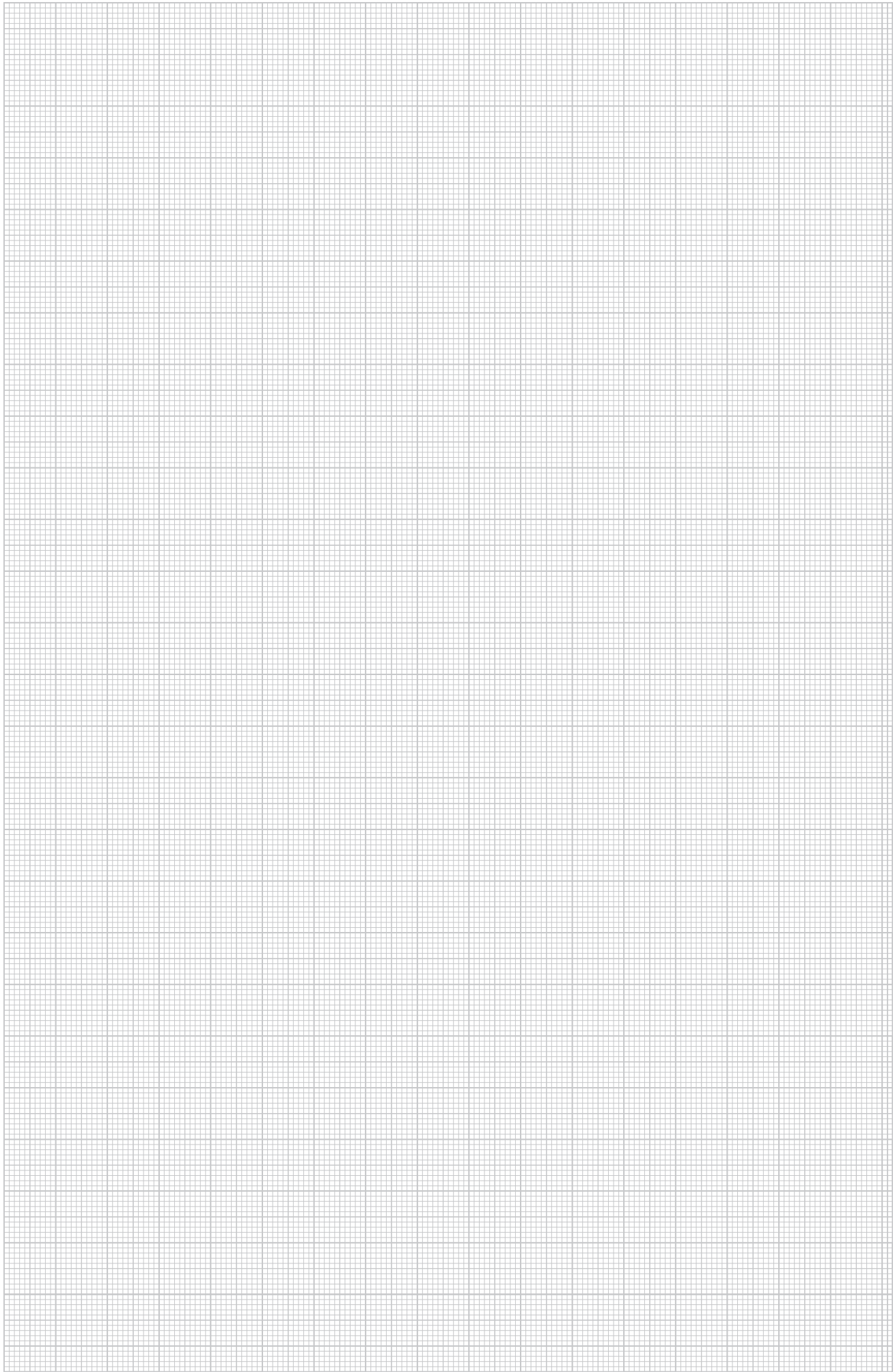



Tarkastusmerkki

	AENOR, Producto Certificado, Spanien
	STOWARZYSZENIE ELEKTRYKÓW POLSKICH, Polen
	CEBEC, Belgia
	DEMKO, Danmarks Elektriske Materielkontrol, Tanska
	ELEKTROTECHNICKÝ ZKUŠEBNÍ ÚSTAV, Tsekin tasavalta
	ATEX-sertifikaatti, räjähdysuojattu
	SGS Fimko, Suomi
	KEMA-KEUR, Alankomaat
	Metristen tuotteiden tunnuksset
	NEMKO, Norja
	Underwriters Laboratories Inc., USA + CSA, Kanada
	Österreichischer Verband für Elektrotechnik, Itävalta
	INSTITUTO ITALIANO DEL MARCHO DI QUALITÀ, Italia
	Underwriters Laboratories Inc., USA
	SEMKO An Inchcape Testing Services Company, Ruotsi
	Eidgenössisches Starkstrominspektorat, Sveitsi
	Underwriters Laboratories Inc., USA
	Verband der Elektrotechnik, Elektronik, Informationstechnik e.V., Saksa



Piktogrammien selitykset

Pintakäsittely

FS	kuumasinkitystä ohutlevystä DIN EN10327 ~20µm
si	kuumasinkitystä ohutlevystä/muovipinnoitettu
BK	kirkas
F	kuumasinkitty upottamalla
g	sinkitty DIN EN12329 2,5-10µm
g	sinkitty / muovipinnoitettu
GGP	sinkitty, keltapassivoitu
GTP	sinkitty, läpinäkyvästi passivoitu
FT	kuumasinkitty upottamalla DIN EN1461 40-60µm
Cu	kuparoitu
N	niklattu
ZD	sinkitty, Deltatone 500
FT	kuumasinkitty upottamalla / SOMY (=paksumpi sinkkikerros)
DD	sinkkialumiinipinnoite, Double Dip
GA	sinkkialumiinipinnoite, Galfan

Standardinmukaisuusmerkki

CE	Communautés Européennes, EY-vaatimustenmukaisuus selvitys EY-normien mukaan
RoHS	RoHS -direktiivin mukainen

Laatumerkki

	halogeenivapaa, ei klooria, fluoria eikä bromia
	itsesammuva 650°C
	itsesammuva 750°C
	itsesammuva 960°C
UV	UV-SÄTEILYÄ KESTÄVÄ

Nimellispoikkipinta

1,5 mm²	Nimellispoikkipinta 1,5 mm²
1,5-2,5 mm²	Nimellispoikkipinta 1,5-2,5 mm²
2,5 mm²	Nimellispoikkipinta 2,5 mm²
2,5-4 mm²	Nimellispoikkipinta 2,5-4 mm²
4 mm²	Nimellispoikkipinta 4 mm²
4-6 mm²	Nimellispoikkipinta 4-6 mm²
6 mm²	Nimellispoikkipinta 6 mm²
10 mm²	Nimellispoikkipinta 10 mm²

Nimellispoikkipinta

16 mm²	Nimellispoikkipinta 16 mm²
---------------	----------------------------

Nimellisjännite

400 V	Nimellisjännite 400 V
500 V	Nimellisjännite 500 V
660 V	Nimellisjännite 660 V

Suojausluokka

IP 20	Suojausluokka IP 20
IP 30	Suojausluokka IP 30
IP 30	Suojausluokka IP 31
IP 44	Suojausluokka IP 54
IP 54	Suojausluokka IP 54
IP 55	Suojausluokka IP 55
IP 65	Suojausluokka IP 65
IP 66	Suojausluokka IP 66
IP 67	Suojausluokka IP 67
IP 68	Suojausluokka IP 68

Aihiot

4	4 ahiota
6	6 ahiota
7	7 ahiota
8	8 ahiota
9	9 ahiota
10	10 ahiota
12	12 ahiota
10	10 ahiota ECO
12	12 ahiota ECO
14	14 ahiota ECO
16	16 ahiota
18	18 ahiota ECO
24	24 ahiota



Napaisuus

3	3-napainen
5	5-napainen
7	7-napainen





Piktogrammien selitykset

Napaisuus

	8-napainen
	10-napainen
	12-napainen





Kaarikiinnikkeet - jalan muoto

	Kaarikiinnike C-profiilikiskolle, rakoleveys 11-12mm
	Kaarikiinnike C-profiilikiskolle, rakoleveys 16-17mm
	Kaarikiinnike C-asennuskiskolle rakoväli 18-22 mm



Rakovälit

	Rakoväli 7,5 mm
	Rakoväli 11 mm
	Rakoväli 11-12 mm
	Rakoväli 12 mm
	Rakoväli 15 mm
	Rakoväli 16 mm
	Rakoväli 16,5 mm
	Rakoväli 16-17 mm
	Rakoväli 17 mm
	Rakoväli 18 mm
	Rakoväli 22 mm
	Rakoväli 35 mm





Halkaisija

	Halkaisija 60mm
	Halkaisija 68 mm
	Halkaisija 70 mm
	Halkaisija 74 mm



Holkkitiivisteet

	Kierre, metrinen
	Kierre PK

Ruuvikannat

	Urakanta
	Torx -kanta
	Ristiurakanta
	Pozidrive-ristikanta



Aihoiden koko

	Aihiot M20
	Aihiot M25
	Aihiot M32
	Aihioi M40



Materiaalit

	Lattateräs
	Kulmateräs
	U-teräs
	Pyöröteräs





Pistooli

	Pulttinaulain
	Naulain





BSS paloluokka

	Paloluokka E 30
	Paloluokka E 90



KTS sivuprofiilin korkeus

	Levyhyily, sivun korkeus 35 mm
	Levyhyily, sivun korkeus 60 mm
	Levyhyily, sivun korkeus 85 mm
	Lankahyily, sivun korkeus 35 mm
	Lankahyily, sivun korkeus 55 mm



BSS palonkestävät johtojärjestelmät

	Poistumistie, kaapelikiinnikkeet kattoasennukseen
	OBO GRIP seinäasennukseen
	OBO GRIP kattoasennukseen
	Kaapelikiinnike, paloluokiteltu, kattoasennus

Palonkestävät kiinnitystarvikkeet

	Kiila-ankkuri
	Betoniruuvi

Valmistusaineet - metallit

	Alumiini
	Teräs, ruostumaton EN 1.4301
	Teräs, ruostumaton EN 1.4310



Piktogrammien selitykset

Valmistusaineet - metallit

VA	Teräs, haponkestävä EN 1.4401
VA	Teräs, haponkestävä EN 1.4404
VA	Teräs, haponkestävä EN 1.4571
CuZn 37	Messinki
St	Teräs
TG	Adusoitu valurauta
Zn	Sinkkipainevalu

Valmistusaineet - muovit

UF	Kestomuovi, aminomuovi tyyppi 131.5
MF	Kestomuovi, melamiinihartsit tyyppi 150
EVA	Etyleenivinyylisetaatti
FA	Kuitutiiviste
NBR SBR	Sekoitus nitrili- ja styreeni-butadieenikumista
NBR	Nitriilikumi
PA	Polyamidi
PA/ GF	Polyamidi, lasikuituvahvisteinen
PC	Polykarbonaatti
PE	Polyeteeni
PBPT	Polybuteenitereftalaatti
PP	Polypropeeni
PP/GF	Polyamidi, lasikuituvahvisteinen
PS	Polystyreeni
PVC	Polyvinyylikloridi
TPE	termoplastinen elastomeeri
ZELL PE	Solu - polyeteeni



Valmistusmateriaalit - metalli

Alu — Alumiini

VA (1.4301) — Teräs, ruostumaton EN 1.4301

VA (1.4310) — Teräs, ruostumaton EN 1.4310

VA (1.4401) — Teräs, haponkestävä EN 1.4401

VA (1.4404) — Teräs, haponkestävä EN 1.4404

VA (1.4571) — Teräs, haponkestävä EN 1.4571

CuZn — Messinki

TG — Adusoitu valurauta

galvaanisesti sinkitty

St — Teräs

Zn — Sinkkipainevalu



Valmistusaineet - muovi

UF — Kestomuovi, aminomuovi tyyppi 131.5

rasioille, holkkiivisteille ja kiinnikkeille

Lämpötilankestävyys:

pysyvästi 65°C:seen, lyhytaikaisesti 90°C:seen

sekä n. -40°C.

Kestää:

Alkoholi, esterit, eetterit, bentseeni, bensiini, mineraaliöljy, rasvat, laimeat emäsluokset, vesi.

Kestää rajoitetusti:

Laimeat hapot

Ei kestä:

väkevät hapot, väkevät emäsluokset

Jännityssäröjen muodostumisvaara

Ei mainittavaa jännityssäröjen muodostumisvaaraa.

MF — Kestomuovi, melamiinihartsit tyyppi 150

liittimille

Lämpötilankestävyys:

pysyvästi 80°C:seen, lyhytaikaisesti 110°C:seen

sekä n. -40°C.

Kestää:

Alkoholi, esterit, eetterit, bentseeni, bensiini, mineraaliöljy, rasvat, laimeat emäsluokset, vesi.

Kestää rajoitetusti:

laimeat hapot

Ei kestä:

väkevät hapot, väkevät emäsluokset

Jännityssäröjen muodostumisvaara

Ei mainittavaa jännityssäröjen muodostumisvaaraa.

EVA — Etyleenivinyylisetaatti

FA — Kuitutiiviste

DIN 28091 mukaan, asbestiton

Lämpötilankestävyys:

enintään 300°C.

NBR/SBR — Sekoitus nitrili- ja styreeni-butadieenikumista

NBR — Nitrilikumi

Lämpötilankestävyys:

pysyvästi 120°C:seen, lyhytaikaisesti noin 150°C:seen

sekä n. -30°C.

Kestää:

Öljyt ja bensiini.

PA — Polyamidi

Lämpötilankestävyys:

pysyvästi noin 90°C:seen, lyhytaikaisesti noin 130°C:seen

sekä n. -40°C.

Kemikaalien kestävyys yleensä kuten polyeteenin kestävyys.

Kestää:

Bensiini, bentseeni, dieselöljy, asetoni, maalien ja lakkojen liuotteet, öljyt ja rasvat.

Ei kestä:

valkaisuliuos, useimmat hapot, kloori

Jännityssäröjen muodostumisvaara

Suhteellisessa ilmankosteudessa vähäinen, vain joillekin vesipitoisille suolaliuksille.

Kuivuneet osat (korkea lämpötila ja hyvin alhainen ilmankosteus) kestävät huonosti polttoaineita ja liuottimia.

PA/GF — Polyamidi, lasikuituvahvisteinen

Lämpötilankestävyys:

pysyvästi noin 100-110°C:seen, lyhytaikaisesti 160°C:seen

sekä n. -40°C.

Kestää:

bensiini, bentseeni, dieselöljy, asetoni, maalien ja lakkojen liuotteet, öljyt ja rasvat.

Jännityssäröjä ei muodostu kovin helposti.

Ei kestä:

valkaisuliuos, useimmat hapot, kloori

Jännityssäröjen muodostumisvaara

Suhteellisessa ilmankosteudessa vähäinen, vain joillekin vesipitoisille suolaliuksille.

Kuivuneet osat (korkea lämpötila ja hyvin alhainen ilmankosteus) kestävät huonosti polttoaineita ja liuottimia.

PC — Polykarbonaatti

Lämpötilankestävyys:

pysyvästi noin 110°C:seen (vedessä 60°C), lyhytaikaisesti 125°C:seen

sekä -35°C.

Kestää:

Bensiini, tärpätti, useimmat laimeat hapot

Ei kestä:

Asetoni, bentseeni, kloori, metyleenikloridi, useimmat väkevöidyt hapot.

Jännityssäröjen muodostumisvaara

Melko vähäinen,

jännityssäröjä voivat aiheuttaa mm. bensiini, aromaattiset hiilivedyt, metanoli, butaani, asetoni, tärpätti.

PE — Polyeteeni

Lämpötilankestävyys:

Kovat laadut pysyvästi noin 90°C:seen, lyhytaikaisesti noin 105°C:seen,

pehmeät laadut pysyvästi noin 80°C:seen, lyhytaikaisesti noin

100°C:seen sekä n. -40°C.

Kestää:

Emäsluokset ja epäorgaaniset hapot

Kestää rajoitetusti:

Asetoni, orgaaniset hapot, bensiini, bentseeni, dieselöljy, useimmat öljyt

Ei kestä:

Kloori, hiilivety, hapettavat hapot

Jännityssäröjen muodostumisvaara

Melko korkea.

Jännityssäröjä voivat aiheuttaa muun muassa asetoni, eri alkoholit, muurahishappo, etanoli, bensiini, bentseeni, voihappo, etikkahappo, formaldehydi, erilaiset öljyt, petroli, propanoli, typpihappo, suolahappo, rikkihappo, saippuoliuokset, tärpätti, trikloorieteeni, sitruunahappo.

PBPT — Polybuteenitereftalaatti

Termoplastinen polyesteri

Lämpötilankestävyys:

pysyvästi noin 120°C:seen, lyhytaikaisesti 140°C:seen

sekä n. -40°C.

Kestää:

Bensiini, dieselöljy, useimmat laimeat hapot, öljyt ja rasvat

Kestää rajoitetusti:

Asetoni, ammoniakki, bentseeni

Ei kestä:

Väkevät hapot, kloori, fluori, promihöyryt, valkaisuliuos, trikloorieteeni, metyleenikloridi.

Jännityssäröjen muodostumisvaara

Vähäinen.



Valmistusaineet - muovi

PP — Polypropeeni

Lämpötilankestävyys:
pysyvästi noin 90°C:seen, lyhytaikaisesti noin 110°C:seen
sekä n. -30°C.
Kemikaalien kestävyys yleensä kuten polyeteenin kestävyys.

Kestää:

emäsluokset ja epäorgaaniset hapot

Kestää rajoitetusti:

Asetoni, orgaaniset hapot, bensiini, bentseeni, dieselöljy, useimmat öljyt

Ei kestä:

Kloori, hiilivety, hapettavat hapot

Jännityssäröjen muodostumisvaara

Vähäinen, vain muutamat hapot kuten kromihapot, fluorivetyhapot ja suolahapot sekä typpioksidi.

PP — Polyamidi, lasikuituvahvisteinen

Lämpötilankestävyys:
pysyvästi noin 90°C:seen, lyhytaikaisesti noin 110°C:seen
sekä n. -30°C.

Kemikaalien kestävyys yleensä kuten polyeteenin kestävyys.

Kestää:

Emäsluokset ja epäorgaaniset hapot

Kestää rajoitetusti:

Asetoni, orgaaniset hapot, bensiini, bentseeni, dieselöljy, useimmat öljyt

Ei kestä:

Kloori, hiilivety, hapettavat hapot

Jännityssäröjen muodostumisvaara

Vähäinen, vain muutamat hapot kuten kromihapot, fluorivetyhapot ja suolahapot sekä typpioksidi.

PS — Polystyreeni

Lämpötilankestävyys:
Koska altistuvuus kemiallisille aineille on suhteellisen korkea, ei suositella käyttöä lämpötiloissa, jotka nousevat yli keskimääräisen huoneen normaallilämpötilan = n. 25°C.
Kylmänkestävyys n. -40°C.

Kestää:

Alkalit, useimmat hapot, alkoholi.

Kestää rajoitetusti:

Öljyt ja rasvat.

Ei kestä:

Voihappo, väk. typpihappo, väk. etikkahappo, asetoni, eetteri, bensiini ja bentseeni, maalien ja lakkojen liuotusaineet, kloori, dieselpolttoaine.

Jännityssäröjen muodostumisvaara

Melko korkea.

Jännityssäröjä voivat aiheuttaa asetoni, eetteri, bensiini, sykloheksaani, heptaani, metanoli, propanoli sekä joidenkin kaapelien PVC-seosten pehmitteet.

PVC — Polyvinyylikloridi

Lämpötilankestävyys:
pysyvästi noin 65°C:seen, lyhytaikaisesti noin 75°C:seen
sekä n. -30°C.

Kestää:

Laimeat hapot, emäsluokset, öljyt ja rasvat, bensiini.

Ei kestä:

Väkevät hapot, bentseeni, asetoni, jodi, tolueeni, trikloorieteeni.

Jännityssäröjen muodostumisvaara

Vähäinen, vain jotkin liuotteet kuten bensiini ja asetoni.

TPE — termoplastinen elastomeeri

ZPE — Solu - polyeteeni

*Miinusarvot pätevät vain lepotilassa oleviin osiin, joihin ei kohdistu mainittavaa iskurasitusta.

Ei ole olemassa minkäänlaista muovia, joka kestäisi kaikkia kemikaaleja.

Esitetyt vaikutukset edustavat vain suppeaa valikoimaa kaikista vaikutuksista. On otettava huomioon, että kemiallisten aineiden ja korkeiden lämpötilojen yhteisvaikutus on erittäin vahingollista muoviosille. Ne voivat mm. aiheuttaa jännityssäröjä. Epäselvissä tapauksissa pyydämme ottamaan yhteyttä tai tilaamaan tarkemman kestävyystaulukon.

Jännityssäröjen muodostuminen: Jännityssäröjä voi muodostua, kun muoviosiin kohdistuu samanaikaisesti sekä vetojännitys että kemiallinen rasitus. Erityisen alttiita tämän suhteen ovat polystyreeni- ja polyeteeniosat. Jännityssäröjä voi syntyä sellaistenkin vaikutusten johdosta, joita kyseinen muoviosa jännitteettömässä olotilassa kestä. Tyypillisiä esimerkkejä osista, jotka ovat normaalkäytössään jatkuvan vetojännityksen alaisia, ovat: tartuntakiinnikkeet, holkkitiivisteiden liitoskappaleet, johdinsiteet.



Kova-PVC:n kemikaalinkestävyys

A = erittäin hyvin kestävä
B = keskimääräisesti kestävä
C = ei kestä

Aineet	Lämpöt. °C	Kestävyys
1,3-butadieeni	20	A
1,3-bentseenisulfonihappo	20	A
2,4-klooribentsoyylilokloridi	20	A
2-aminoetikka-2,2-difenyylettikkahappo	20	A
4-kloori-2-nitroaniliini	20	C
4-klooribentsaldehydi-2-sulfonihappo	20	A
5-amino-2-hydroksibentsoehartsihappo	20	A
Abietinihappo	20	A
Adipiinihappo	20	A
Adipiinihappo	60	B
Alikloorihapoke	60	A
Alitsariini 100%	20	A
Aikanisulfonihapot	50	A
Alkoholipitoiset juomat	< 40	A
Allyylialkoholi 100%	20	B
Allyylialkoholi 100%	60	C
Allyylikloridi	20	C
Aminobentseeni (p-)	20	A
Ammoniakki (kaikkien pitoisuuksien höyryt)	40	A
Ammoniakki (kaikkien pitoisuuksien höyryt)	60	B
Ammoniakki, vedetön, nestemäinen	< 60	B
Ammoniumhydroksidi	60	A
Ammoniumsalisyylilohappo (p-)	20	A
Aniliini 100%	20	A
Aniliinikloridi, kyllästetty liuos	20	C
Asetaatit (ammonium-, Na- ym.)	50	A
Asetaldehydi 100%	20	C
Asetaldehydi 40%	20	A
Asetaldehydi 40%	40	B
Asetaldehydi, etikkahappopitoinen 90:10	20	B
Asetanilidi 100%	20	A
Asetofenoni (metyylifenyylketoni)	20	C
Asetoni	20	C
Asetyleeni 100%	20	B
Asetyyliasetoni (2,4-pentadioni)	20	C
Asetyyliisalisyylihappo	20	A
Askorbiinihappo	20	A
Asparagiinihappo	20	A
Bensiini, bentseenipitoinen	20	C
Bensiini, ei-aromaattinen	60	A
Bentseeni	20	C
Bentseenisulfonihappo	60	A
Bentsofenoni 100%	20	C
Bentsoehartsihapon anhydridi	30	A
Bentsoehartsihappo	40	A
Bentsotrifluoridi	20	C
Bentsotrikloridi	20	C
Bentsoylibentsoehartsihappo	20	A
Bentsyylikloridi	20	C
Beteeni	20	A
Booraksi	40	A
Boorifluorivetyhappo	20	A
Boorihappo	20	A
Boraatit (NA-)	20	A
Bromaattit (K-, Na-)	40	A
Bromi, kaasumainen, kuiva	20	A
Bromi, nestemäinen	20	C
Bromibentseeni	20	C
Bromidit (K-, Na- mm.)	60	A
Bromihappo	20	A
Bromikloorimetaani	20	C
Bromiklooripropaani	20	C
Bromivesi	20	A
Bromivety 100%	20	A
Bromivety 100%	60	B
Bromivetyhappo 40%:iin asti	60	A
Bromoformi 100%	20	C
Butaani, kaasumainen, 30%	20	A
Butaanidioli 10%:in asti	20	A
Butaanidioli yli 60%	40	B
Butaanidioli yli 60%	20	C
Butanoli	60	A
Butyyliasetaatit	20	C
Butyylibutyyraatti	20	C
Butyyliifenoli	20	C
Butyyliiglykolaatti	20	C
Butyylikloridi	20	C
Dibromieteeni	20	C
Dibutyyliiftalaatti	20	C
Dibutyylioksaalaatti	20	C
Dietyyliamiini 100%	20	C
Dietyyलिएetteri	20	C
Dietyyliiglykoli	60	C
Difenyylilohppi	20	C
Difenyylimiamiini	20	C

A = erittäin hyvin kestävä
B = keskimääräisesti kestävä
C = ei kestä

Aineet	Lämpöt. °C	Kestävyys
Dikloroeteeni	20	C
Dikloropropeeni	20	C
Dikromaattit (K-, Na-)	50	C
Dimetyylieetteri	20	C
Di-n-butyyलिएetteri	20	C
Dioksiini	20	C
Dietyyliiftalaatti	20	C
Etaani	20	A
Etanoli	40	A
Etanoliamiini	20	B
Eteeniglykoli	20	A
Etikka-anhydridi	20	C
Etikkahappo 100%	60	A
Etikkahappo 100%	20	A
Etikkahappo 100%	60	B
Etikkahappo 25%	40	A
Etikkahappo 25-70%	40	A
Etyyliakrylaatti	20	C
Etyyliasetaatit	20	C
Etyylibentseeni	20	C
Etyylikloridi	20	C
Fenoli 1%	20	A
Fenoli 90%	45	B
Fenyylhydratsiini	20	C
Fenyylhydratsiiniokloridi	20	B
Fenyylhydratsiiniokloridi	60	C
Fluori	20	B
Fluori	60	C
Fluoridit (ammonium-, K-, Na- ym.)	60	A
Fluorivetyhappo 40%:in asti	40	A
Fluorivetyhappo 40%:in asti	60	B
Formaldehydi	60	A
Formamidi 100%	20	C
Formiaatit (ammonium- ym.)	20	A
Fosfaatit (ammonium-, Na- ym.)	60	A
Fosforihappo	40	A
Fosforihappo	60	B
Fosforipentoksidi	20	A
Fosgeeni, kaasumainen	20	A
Fosgeeni, kaasumainen	60	B
Fosgeeni, nestemäinen	20	C
Furfuraaliokholi	20	C
Furfuroli	20	C
Gelatiini	60	A
Glukonihappo	20	A
Glukoosi	60	A
Glutaminiinihappo	20	A
Glykoli	60	A
Glyseroli	60	A
Glysiini	40	A
Happi	60	A
Heksafluoripiihappo 32%	60	A
Heksafluorisilikaatit (ammonium-, K- ym.)	60	A
Heksakloorietaani	20	C
Heksametyleenitetramiini (urotropiini) 40% vesiliuos	60	A
Heksasyaaniferraatti-II (Na-)	40	A
Heksasyaaniferraatti-III (K-)	40	A
Heptaani	20	A
Hiilidioksidit	60	A
Hiilimonoksidi	60	A
Humiinihapot	20	A
Hydratsiini laimennettu liuos 100%	20	C
Hydratsiini laimennettu liuos 30%	20	A
Hydroksidit (K-, Na-)	60	A
Hydroksidit (maa-alkalimetalli-)	60	A
Hypokloriitit (K-, Na- ym.)	60	A
Isobutyyliifosfaatit	20	C
Jodaatit (K-, Na- ym.)	60	A
Jodi	20	C
Jodidit (K-, Na-)	60	A
Kalanmaksajly	20	A
Kasviöllyt	40	A
Kehite	40	A
Kiinnitysliuos	60	A
Kirpumiä	20	A
Kloori, kaasumainen, kostea 5%	20	B
Kloori, kaasumainen, kuiva 0,5%	20	A
Kloori, kaasumainen, kuiva 100%	20	B
Kloori, nestemäinen	20	C
Kloorianiliini	20	C
Klooriasetaldehydi	20	C
Klooriasetoni	20	C
Klooriasetyylikloridi	20	C
Klooribentsaldehydi	20	C



Kova-PVC:n kemikaalinkestävyys

A = erittäin hyvin kestävä
B = keskimääräisesti kestävä
C = ei kestä

Aineet	Lämpöt. °C	Kestävyys
Klooribentseeni	20	C
Klooribentsootrifluoridi	20	C
Klooribentsoyylikloridi	20	C
Kloorietikkahappo	20	A
Kloorietylibentseeni	20	C
Kloorihappo 20%:in asti	40	A
Kloorihappo 20%:in asti	60	B
Kloorikresoli	20	C
Kloorinaftaliini	20	C
Kloorinitrobensoehartsihappo	20	A
Kloorisyaani	20	A
Kloorivesi (kylästetty liuos)	20	B
Kloorivety (kaasumainen, kuiva ja kostea)	40	A
Kloraatit (K-, Na-, mm.)	20	A
Kloraatit (K-, Na-, mm.)	60	B
Kloraatit (K-, Na-, mm.)	60	A
Kloridit (ammonium-, Na- ym.)	20	A
Kloroformi	20	C
Kresoli	20	C
Kromaattit (K-, Na- 50%:in asti)	50	A
Kromialuna	60	A
Kromihappo 50%:in asti	40	A
Kromiikkihappo	30	A
Ksyleenit	20	C
Kumeeni	20	C
Linohappo	60	A
Lyijytetraetyyli	60	A
Maito	20	A
Maitohappo 10%	20	A
Maitohappo 10%	60	C
Maitohappo 100%	20	C
Metanoli 100%	40	A
Metanoli 100%	60	B
Metyleenikloridi	20	C
Metyyliamiini	20	B
Metyylibromidi	20	C
Metyylikloridi	20	C
Metyylimetakrylaatti	20	C
Mineraaliöljyt	60	C
Muuntajaöljy	60	A
Muurahaishappo 100%	20	B
Muurahaishappo 100%	60	C
Muurahaishappo 50%	40	A
N, N-dietyylianiiliini	20	C
Naftaliini	20	C
Nitraatit (ammonium-, K- ym.)	60	A
Nitriitit (K-, Na- ym.)	60	A
Nitrobensoeni	20	C
Nitroglyseroli	20	B
Oksaalihiappo	40	A
Oksalaatit (ammonium-, Na- ym.)	60	A
Öljyhappo	60	A
Olut	60	A
Olutvierre	20	A
Omenahappo	20	A
Omenamehu	60	A
Otsoni 10%	30	A
Otsoni 10%	60	B
Palmitiinihiappo	20	A
Parafiini	40	A
Parkitusliemi	20	A
Pellavaöljy	60	A
Pentyylialkoholi	60	A
Pentyyliasettaatti	20	C
Pentyylikloridi	20	C
Pentyyliauraatti	20	C
Perbonaatti (K-)	60	A
Perkloorihappo 70%	20	A
Perklooraatti	40	A
Permanganaatti (K-) 6% - 15%	40	A
Permanganaatti (K-) 6% - 15%	60	B
Permanganaatti (K-) 6%:in asti	60	A
Peroksimonorikkihappo	20	A
Persulfaatti (ammonium-, K- ym.)	40	A
Petroli	60	A
Propaani	20	A
Propanoli	60	A
Puuterva	20	C
Pyridiini	20	A
Rikkidioksidi (kaasumainen, kuiva ja kostea) 100%	60	A
Rikkihapoke	60	A
Rikkihappo 40%:in asti	20	C
Rikkihappo 50%:in asti	50	A

A = erittäin hyvin kestävä
B = keskimääräisesti kestävä
C = ei kestä

Aineet	Lämpöt. °C	Kestävyys
Rikkihappo 50%:in asti	60	A
Rikkihappo 80%:in asti	40	C
Rikkihappo 80%:in asti	60	B
Rikkihappo 96%:in asti	20	A
Rikkihappo 96%:in asti	60	B
Rikkihappo, savuava (10%:nen oleum)	20	C
Rikkihiili 100%	20	B
Rikkivety	60	A
Risiniöljy	60	A
Rodanidi (ammonium- ym.)	60	A
Rypälesokeri	50	A
Saippualiuos	40	A
Saisilyhihappo	20	A
Silava	20	A
Silikaatit (K-)	20	A
Sitraatit (ammoniumi-, Na)	20	A
Sitruunahappo	20	A
Sitruunahappo	60	B
Steariinihiappo	60	A
Sulfaattit (ammonium-, Na- ym.)	60	A
Sulfaniilihiappo (m-, o-, p-)	20	A
Sulfiitit (ammonium-, Na- ym.)	60	A
Suolahappo 30%:in asti	20	A
Suolahappo 30%:in asti	60	B
Suolahappo 37%:in asti	20	A
Suolahappo 37%:in asti	40	B
Suolavesi	60	A
Syaaniasetaamidi	20	A
Syaanietikkahappo	20	C
Syaanivetyhihappo	40	A
Syanidit (K-, Na- 50%:in asti)	60	A
Sykloheksanoli	20	C
Sykloheksanoni	20	C
Talli	60	A
Tärkki	60	A
Tärpähti	20	A
Terva, ei-aromaattinen	20	A
Tetrahydrofuraani	20	C
Tolueni	20	A
Triklorieteeni	20	C
Typpihapoke 50%:in asti	50	A
Typpihapoke 98%:in asti	20	C
Typpihappo 25%	20	A
Typpihappo 25%	60	B
Typpihappo 50%	20	A
Typpihappo 50%	50	B
Typpihappo 95%	20	C
Typpioksiidi	20	C
Valkaisuliuos, 12% aktiivikloori	40	A
Valkaisuliuos, 12% aktiivikloori	60	B
Valokaasu	20	A
Veri	40	A
Vernissa	60	C
Vesi	40	A
Vesi	60	B
Vetyperoksiidi 30%:in asti	60	A
Vetyperoksiidi 90%:in asti	20	A
Viini	40	A
Viinietikka	50	A
Viinihappo	60	A
Vinyylisetaatti	20	C
Virtsaahappo	60	C
Viskoosikehrulluokset	60	A
Voihappo 100%	20	C
Voihappo 20%	20	A
Voihappo 20%	60	C



Käytetyn kova-PVC:n materiaaliominaisuudet		
Materiaalinimike	DIN 7748	PVC-U-E-D-080-
04-28 mukaan		
Vetolujuus	DIN 53 455 mukaan	min. 40 N/mm ²
Murtovenymä	DIN 53 455 mukaan	min. 65%
Läpilyöntiliujuus	DIN 53 481 mukaan	min. 20 KV/mm
Pintavastus	DIN 53 482 mukaan	min. 10 10
Lämpömitanpitävyys	DIN 53 460/B mukaan	min. 75 °C
Lämpötilankestävyys käytössä maks.	65 °C	
Syttyvyys	UL 94 mukaan taso V-0	
Hehkulankakoe	DIN IEC 695 mukaan 960 °C	
Rakennusaineluokitus	DIN EN 4102 mukaan, hyväksytty luokkiin B1 ja B2	

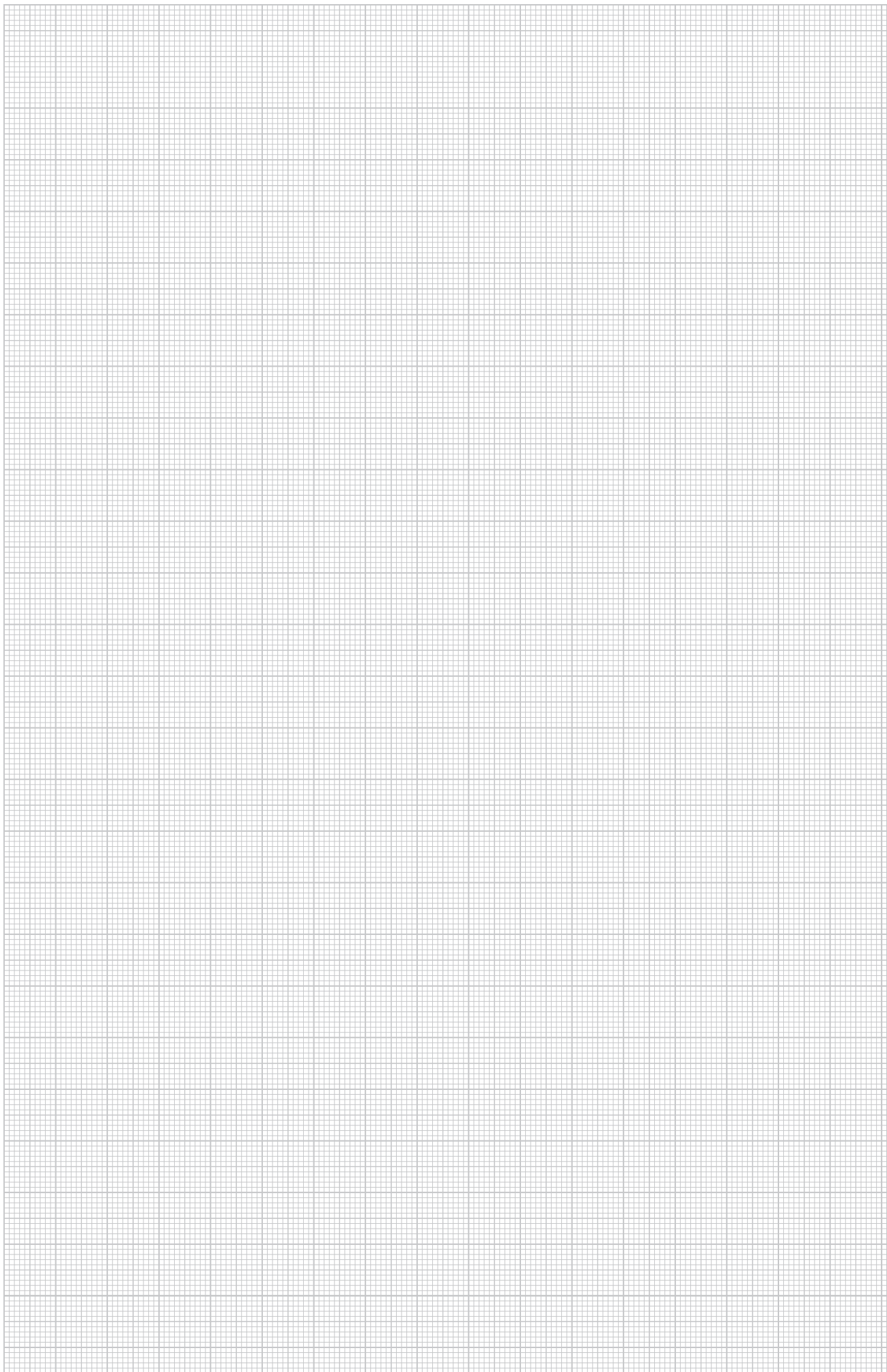





Palkkiinnikkeet

	Palkkiinnikkeet, lyötävät	Ripustuskiinnikkeet Putkiinnikkeet Kaapeliinnikkeet	316 316 317
	Palkkiinnikkeet, ruuvattavat	Ripustuskiinnikkeet Putkiinnikkeet Kierretankokiinnikkeet	319 319 319
	Muut palkkiinnikkeet	Kiskokiinnike Mutteri	320 320
		Kattokiinnike Palkkiinnike 339 Palkkiinnike asennuskiskolle 1268	320 320 321
		Asennuskisko	321
	Asennustarvikkeet	Kiinnitysvanne	323
		Kattokiinnike	323
		Kulmakappale	323
		Kiinnityskappale 90°	323
		Ketju	323
		Koukku	323
		Liukuruuvi	323

Palkkiinnikkeet, lyötävät



Palkkiinnike, läpireikä

Tyyppi	Laippa	Mitta B	Mitta H	Mitta E	Murto-kuorma	Pakk.	Paino	Tuotenumero	Tuotenumero
	mm	mm	mm	mm	kN	kpl	kg/100 kpl		Snro
TK 6-0	2-6	33,3	30	6,5	0,9	100	1,350	1481 01 0	1317602
TK 13-0	5-13	33,3	37	7	0,9	100	1,550	1481 02 9	1317605
TK 19-0	14-19	33,3	43	7	0,9	100	2,490	1481 04 5	1317614

St Teräs **ZD** sinkitty, Deltatone 500 €/100 kpl
 Porareillä S-koukun tai ruuvin ja mutterin kiinnitykseen

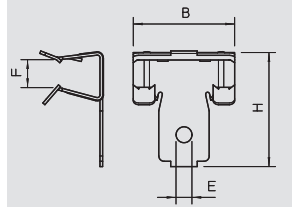

Palkkiinnike, sisäkierteellä

Tyyppi	Laippa	Murto-kuorma	Pakk.	Paino	Tuotenumero	Tuotenumero
	mm	kN	kpl	kg/100 kpl		Snro
TKI 7-6	3-6,5	0,45	100	2,350	1483 57 9	
TKI 13-6	7-13	0,45	100	2,350	1483 58 7	
TKI 19-6	14-19	0,45	100	3,050	1483 59 5	

St Teräs **ZD** sinkitty, Deltatone 500 €/100 kpl
 Sisäkierteellä M6

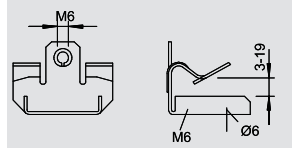

Palkkiinnike, kierretapilla

Tyyppi	Laippa	Mitta B	Mitta H	Kierre	Murto-kuorma	Pakk.	Paino	Tuotenumero	Tuotenumero
	mm	mm	mm		kN	kpl	kg/100 kpl		Snro
TK-G 4	2-4	28	28	M6 x 9	0,45	100	0,900	1481 10 2	
TK-G 9	5-9	38	32	M6 x 9	0,45	100	1,600	1481 10 8	
TK-G 16	10-16	38	42	M6 x 9	0,45	100	1,830	1481 11 4	
TK-G 20	17-20	38	49	M6 x 9	0,45	100	2,000	1481 12 0	

St Teräs **ZD** sinkitty, Deltatone 500 €/100 kpl
 M6 x 9 mm kierretapilla kiinnikkeiden tai muiden rakenneosien kiinnitykseen.



Tyyppi	Laippa	Murto-kuorma	Pakk.	Paino	Tuotenumero	Tuotenumero
	mm	kN	kpl	kg/100 kpl		Snro
TKG 7-6	3-6,5	0,45	100	2,400	1483 44 7	
TKG 13-6	7-13	0,45	100	2,400	1483 45 5	
TKG 19-6	14-19	0,45	100	3,100	1483 46 3	

St Teräs **ZD** sinkitty, Deltatone 500 €/100 kpl
 Kierretappi M6 x 7,5 mm sisäkierteellä.

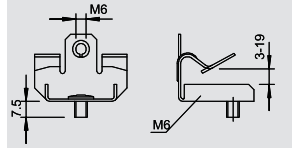
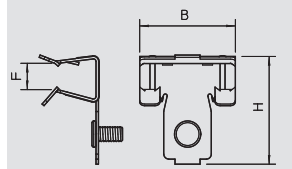

Palkkiinnike, johdinsiteellä

Tyyppi	Laippa	Kaapeli-siten pituus	maks. paks.	Mitta A	Murto-kuorma	Pakk.	Paino	Tuotenumero	Tuotenumero
	mm	mm	Ø	mm	kN	kpl	kg/100 kpl		Snro
TKK 6-240	2-6	240	70	7,6	0,8	100	2,200	1481 40 1	1317607
TKK 6-365	2-6	365	110	7,6	0,8	100	1,300	1481 42 8	
TKK 13-240	5-13	240	70	7,6	0,8	100	1,900	1481 45 2	1317609
TKK 13-365	5-13	365	110	7,6	0,8	100	2,000	1481 46 0	
TKK 19-240	14-19	240	70	7,6	0,8	100	2,300	1481 53 3	
TKK 19-365	14-19	365	110	7,6	0,8	100	2,400	1481 54 1	

St Teräs **ZD** sinkitty, Deltatone 500 €/100 kpl
 Johdinsiteillä kaapelinippujen kiinnittämiseen.

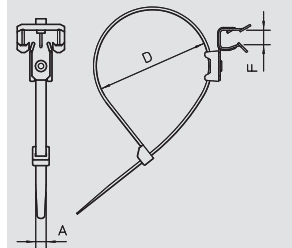

Palkkiinnike, asennusnauhalle

Tyyppi	Laippa	Murto-kuorma	Pakk.	Paino	Tuotenumero	Tuotenumero
	mm	kN	kpl	kg/100 kpl		Snro
TKR 6	2-6	0,9	100	1,800	1481 70 3	
TKR 9	5-9	0,9	100	2,400	1481 71 1	
TKR 19	14-19	0,9	100	3,400	1481 74 6	

St Teräs **ZD** sinkitty, Deltatone 500 €/100 kpl
 Kiertyvällä kiinnityskappaleella asennuspantaa varten

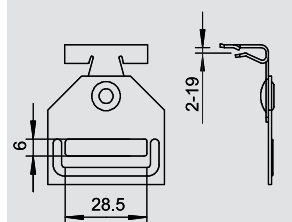

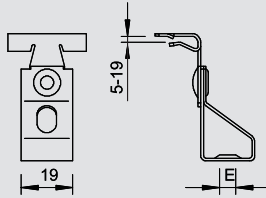

Palkkiinnike, kierretangolle

Tyyppi	Laippa mm	Kierretangolle M	Mitta E mm	Mitta A mm	Murto- kuorma kN	Pakk. kpl	Paino kg/100 kpl	Tuotenumro	Tuotenumro Snro
TKR 13-6	5-13	M6	6	52	0,9	100	3,040	1482 06 8	
TKR 13-8	5-13	M8	8	52	0,9	100	3,040	1482 07 6	
TKR 13-10	5-13	M10	10	52	0,9	100	3,040	1482 08 4	1317650
TKR 19-6	14-19	M6	6	59	0,9	100	3,180	1482 11 4	
TKR 19-8	14-19	M8	8	59	0,9	100	3,180	1482 12 2	

St Teräs ZD sinkitty, Deltatone 500 €/100 kpl
Kääntyvällä kiinnitysosalla kierretangolle.

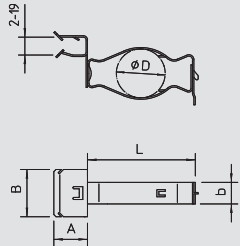

Palkkiinnike, asennusputkille

Tyyppi	Laippa mm	Kiinnitysmitta D mm	Murto- kuorma kN	Pakk. kpl	Paino kg/100 kpl	Tuotenumro	Tuotenumro Snro
TKS 6-25	2-6	18-25	0,45	100	2,490	1483 01 3	
TKS 6-32	2-6	28-32	0,45	100	3,180	1483 02 1	
TKS 6-37	2-6	35-37	0,45	100	3,450	1483 04 8	
TKS 6-42	2-6	37-42	0,45	100	3,900	1483 05 6	
TKS 13-25	5-13	18-25	0,45	100	2,720	1483 10 2	
TKS 13-32	5-13	28-32	0,45	50	3,080	1483 11 0	
TKS 13-37	5-13	35-37	0,45	50	3,540	1483 12 9	
TKS 13-42	5-13	37-42	0,45	50	4,600	1483 13 7	
TKS 19-25	14-19	18-25	0,45	50	4,500	1483 30 7	
TKS 19-32	14-19	28-32	0,45	50	4,700	1483 31 5	
TKS 19-37	14-19	35-37	0,45	50	4,850	1483 32 3	

St Teräs ZD sinkitty, Deltatone 500 €/100 kpl
Kääntyvällä kiinnikeosalla putkien kiinnittämiseen, lukkiutuva.

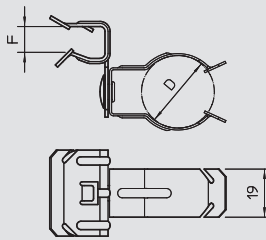

Tyyppi	Laippa mm	Kiinnitysmitta D mm	Murto- kuorma kN	Pakk. kpl	Paino kg/100 kpl	Tuotenumro	Tuotenumro Snro
TKC 6-20	2-6	17-20	0,11	100	2,220	1482 40 8	
TKC 6-25	2-6	23-25	0,11	100	2,720	1482 41 6	
TKC 13-20	5-13	17-20	0,11	100	1,500	1482 46 7	
TKC 13-25	5-13	23-25	0,11	100	1,770	1482 47 5	
TKC 13-32	5-13	25-32	0,11	100	1,900	1482 48 3	
TKC 19-20	14-19	17-20	0,11	50	1,770	1482 60 2	
TKC 19-25	14-19	23-25	0,11	50	1,810	1482 61 0	
TKC 19-32	14-19	25-32	0,11	50	2,130	1482 62 9	

St Teräs ZD sinkitty, Deltatone 500 €/100 kpl
Kääntyvällä kiinnikeosalla putkien kiinnittämiseen.

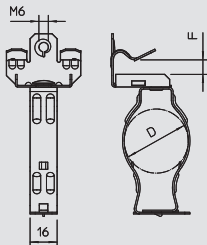

Tyyppi	Laippa mm	Kiinnitysmitta D mm	Murto- kuorma kN	Pakk. kpl	Paino kg/100 kpl	Tuotenumro	Tuotenumro Snro
TKSU 7-25	3-6,5	18-25	0,11	5	3,700	1484 30 3	
TKSU 7-32	3-6,5	28-32	0,11	50	4,050	1484 31 1	
TKSU 7-37	3-6,5	35-37	0,11	50	4,400	1484 33 8	
TKSU 7-42	3-6,5	37-42	0,11	25	4,800	1484 34 6	
TKSU 13-25	7-13	18-25	0,11	50	4,150	1484 40 0	
TKSU 13-32	7-13	28-32	0,11	50	4,450	1484 41 9	
TKSU 13-37	7-13	35-37	0,11	50	4,750	1484 42 7	
TKSU 13-42	7-13	37-42	0,11	25	5,520	1484 43 5	
TKSU 19-25	14-19	18-25	0,11	50	4,550	1484 50 8	
TKSU 19-32	14-19	28-32	0,11	50	4,900	1484 51 6	
TKSU 19-37	14-19	35-37	0,11	25	5,450	1484 52 4	

St Teräs ZD sinkitty, Deltatone 500 €/100 kpl
Kääntyvällä kiinnikeosalla putkien kiinnittämiseen, lukkiutuva.

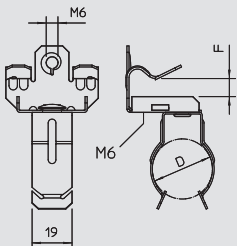

Tyyppi	Laippa mm	Kiinnitysmitta D mm	Murto- kuorma kN	Pakk. kpl	Paino kg/100 kpl	Tuotenumro	Tuotenumro Snro
TKCU 7-20	3-6,5	17-20	0,11	5	3,760	1484 00 1	1317720
TKCU 7-25	3-6,5	23-25	0,11	50	3,900	1484 02 8	
TKCU 7-32	3-6,5	25-32	0,11	50	4,350	1484 03 6	1317732
TKCU 13-20	7-13	17-20	0,11	50	4,220	1484 07 9	
TKCU 13-25	7-13	23-25	0,11	50	4,350	1484 08 7	1317721
TKCU 13-32	7-13	25-32	0,11	50	4,800	1484 09 5	1317733
TKCU 19-20	14-19	17-20	0,11	50	4,450	1484 13 3	1317722
TKCU 19-25	14-19	23-25	0,11	50	4,550	1484 14 1	
TKCU 19-32	14-19	25-32	0,11	50	5,350	1484 16 8	1317734

St Teräs ZD sinkitty, Deltatone 500 €/100 kpl
Kääntyvällä kiinnikeosalla putkien kiinnittämiseen.



Palkkiinnikkeet, lyötävät



Palkkiinnike, asennusputkille

Tyyppi	Laippa mm	Mitta D mm	Mitta B mm	Kaapelin Ø mm	Pakk. kpl	Paino kg/100 kpl	Tuoteno	Tuoteno Snro
TKCI 5-7	1,5-5	5,5-7	13,5	5,5-7	100	0,300	1487 00 0	
TKCI 5-9	1,5-5	8-9,5	13,5	8-9,5	100	0,300	1487 01 9	
TKCI 5-11	1,5-5	9,5-11	13,5	9,5-11	100	0,400	1487 02 7	
TKCI 5-14	1,5-5	12-14	13,5	12-14	100	0,400	1487 03 5	1317751
TKCI 5-18	1,5-5	13-18	13,5	13-18	100	0,600	1487 04 3	1317752
TKCI 5-24	1,5-5	19-24	13,5	19-24	100	0,500	1487 05 1	1317753
TKCI 5-32	1,5-5	25-32	13,5	25-32	100	0,700	1487 07 8	1317754
TKCI 7-7	5-7	5,5-7	13,5	5,5-7	100	0,400	1487 20 5	
TKCI 7-9	5-7	8-9,5	13,5	8-9,5	100	0,400	1487 21 3	
TKCI 7-11	5-7	9,5-11	13,5	9,5-11	100	0,400	1487 22 1	
TKCI 7-14	5-7	12-14	13,5	12-14	100	0,400	1487 24 8	1317761
TKCI 7-18	5-7	13-18	13,5	13-18	100	0,400	1487 25 6	1317762
TKCI 7-24	5-7	19-24	13,5	19-24	100	0,500	1487 26 4	1317763
TKCI 7-32	5-7	25-32	13,5	25-32	100	0,700	1487 27 2	1317764
TKCI 12-7	8,5-12,5	5,5-7	13,5	5,5-7	100	0,400	1487 41 8	
TKCI 12-9	8,5-12,5	8-9,5	13,5	8-9,5	100	0,400	1487 42 6	
TKCI 12-11	8,5-12,5	9,5-11	13,5	9,5-11	100	0,400	1487 43 4	
TKCI 12-14	8,5-12,5	12-14	13,5	12-14	100	0,400	1487 44 2	1317771
TKCI 12-18	8,5-12,5	13-18	13,5	13-18	100	0,500	1487 45 0	1317772
TKCI 12-24	8,5-12,5	19-24	13,5	19-24	100	0,600	1487 46 9	1317773
TKCI 12-32	8,5-12,5	25-32	13,5	25-32	100	0,700	1487 47 7	1317774

St Teräs ZD sinkitty, Deltatone 500 €/100 kpl

Kiinnikeosalla



Tyyppi	Laippa mm	Mitta L mm	Mitta B mm	Mitta H mm	Pakk. kpl	Paino kg/100 kpl	Tuoteno	Tuoteno Snro
TKCI-A	12-20	37	25	32	5	1,700	1487 49 6	

St Teräs ZD sinkitty, Deltatone 500 €/100 kpl

Palkkiinnikkeen TKCI 5 kiinnityskappale laippapaksuuksille 12-20 mm, kolmella kiinnityskohdalla.

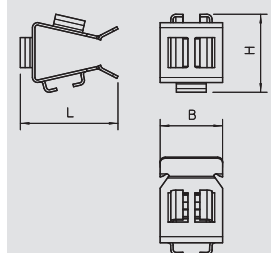
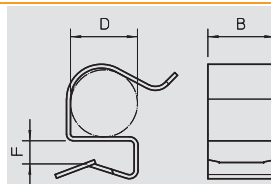

Palkkiinnike, kiinnityskappaleella



Tyyppi	Laippa mm	Murto- kuorma kN	Pakk. kpl	Paino kg/100 kpl	Tuoteno	Tuoteno Snro
TKB 6	2-6	0,8	100	2,100	1481 20 7	
TKB 13	5-13	0,8	100	2,800	1481 21 5	
TKB 19	14-19	0,8	50	3,200	1481 23 1	

St Teräs ZD sinkitty, Deltatone 500 €/100 kpl

Joustavalla kiinnityspisteellä yksittäisten kaapelien tai nippujen kiinnittämiseen.

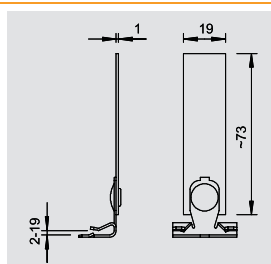

Palkkiinnike, kiinnityskappaleella



Tyyppi	Laippa mm	Mitta H mm	Mitta L mm	Murto- kuorma kN	Pakk. kpl	Paino kg/100 kpl	Tuoteno	Tuoteno Snro
TKL 4	1,5-4	52	10	0,72	100	0,860	1485 10 5	
TKL 6	4-6	54	12	0,72	100	1,090	1485 11 3	

St Teräs ZD sinkitty, Deltatone 500 €/100 kpl

Reiällä, erilaisiin kiinnityksiin.

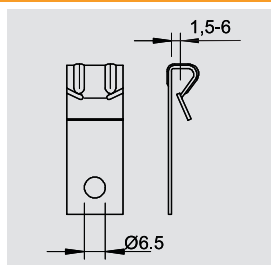

Palkkiinnike

Tyyppi	Laippa mm	Kiinnitysmitta D mm	Pakk. kpl	Paino kg/100 kpl	Tuoteno	Tuoteno Snro
TC 7-10 ZD	5-7	3-10	100	0,750	1487 70 1	
TC 9-20 ZD	8-9	7-20	100	0,880	1487 72 8	

St Teräs ZD sinkitty, Deltatone 500 €/100 kpl

Kiinnikeosalla

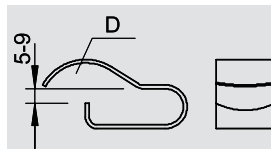

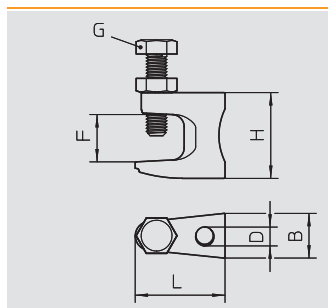

Palkkikiinnike läpireiällä



Tyyppi	Laippa mm	Mitta H mm	Mitta B mm	Mitta L mm	Mitta G mm	Mitta D mm	Murto- kuorma kN	Pakk. kpl	Paino kg/100 kpl	Tuotenumro	Tuotenumro Snro
FL 1 TG	0-18	35	19	38	M8	9	1,2	5	8,500	1488 01 5	1339801
FL 2 TG	0-20	42	21	44	M10	11	2,5	50	14,000	1488 02 3	1339802
FL 3 TG	0-26	54	23,5	58	M10	13	3,5	25	18,000	1488 03 1	1339803

TG Adusoiitu valurauta
läpireiällä

€/100 kpl

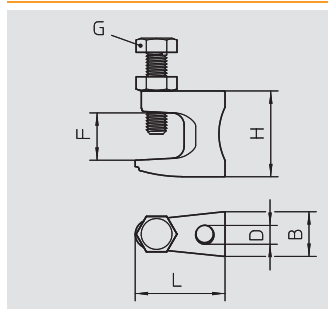

Palkkikiinnike, kierrereiällä



Tyyppi	Laippa mm	Mitta H mm	Mitta B mm	Mitta L mm	Mitta G mm	Kierretangolle tangolle	Murto- kuorma kN	Pakk. kpl	Paino kg/100 kpl	Tuotenumro	Tuotenumro Snro
FL1-G M8 TG	0-18	35	19	38	M8	M8	1,2	5	8,500	1488 07 4	1339808
FL2-G M10 TG	0-20	42	21	44	M10	M10	2,5	50	14,000	1488 08 2	1339810
FL3-G M12 TG	0-26	54	23,5	58	M10	M12	3,5	25	18,000	1488 09 0	1339812

TG Adusoiitu valurauta
kierteellä

€/100 kpl

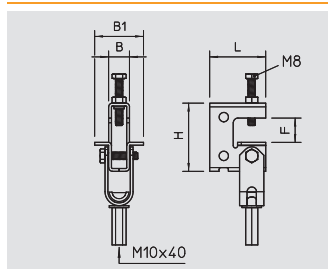

Palkkikiinnike, niveellä ja kierretangolla

Tyyppi	Laippa mm	Kierretangolle tangolle	Murto- kuorma kN	Pakk. kpl	Paino kg/100 kpl	Tuotenumro	Tuotenumro Snro
TK FL G	0-24	M10	0,9-2,8	1	34,000	1488 11 1	

St Teräs **ZD** sinkitty, Deltatone 500

€/100 kpl

Palkkikiinnike vaivattomaan kiinnitykseen palkkeihin ilman hitsausta ja porausta.
Enimmäiskuormitus riippuu kuormitus suunnasta.

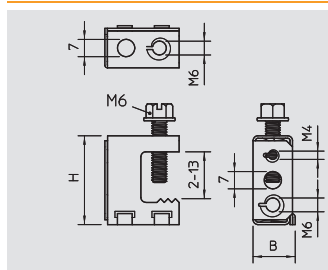

Palkkikiinnike, yleiskiinnike

Tyyppi	Laippa mm	Murto- kuorma kN	Mitta B mm	Mitta H mm	Pakk. kpl	Paino kg/100 kpl	Tuotenumro	Tuotenumro Snro
TK 213	2-13	1,35	15,8	35	100	2,720	1484 70 2	

St Teräs **ZD** sinkitty, Deltatone 500

€/100 kpl

Erilaisia kiinnitysmahdollisuuksia (vaaka- ja pystysuoraan).

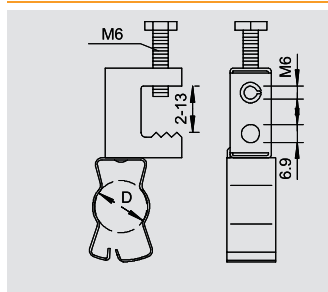

Palkkikiinnike asennusputkille

Tyyppi	Laippa mm	Kiinnitysmitta D mm	Murto- kuorma kN	Pakk. kpl	Paino kg/100 kpl	Tuotenumro	Tuotenumro Snro
TKS 213-25	2-13	18-25	0,45	5	3,990	1484 81 8	
TKS 213-32	2-13	28-32	0,45	50	4,170	1484 82 6	
TKS 213-37	2-13	35-37	0,45	50	6,300	1484 83 4	
TKS 213-42	2-13	37-42	0,45	50	7,300	1484 84 2	

St Teräs **ZD** sinkitty, Deltatone 500

€/100 kpl

Kääntävällä kiinnikeosalla asennusputkien kiinnittämiseen, lukkiutuva.

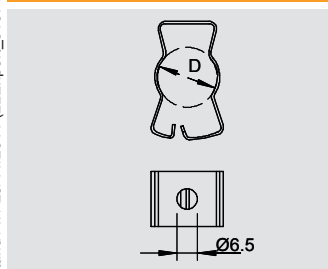

Putkikiinnike

Tyyppi	Kiinnitysmitta D mm	Murto- kuorma kN	Pakk. kpl	Paino kg/100 kpl	Tuotenumro	Tuotenumro Snro
S 25 ZD	18-25	0,45	100	1,420	1486 30 6	
S 32 ZD	28-32	0,45	100	1,550	1486 31 4	
S 37 ZD	35-37	0,45	100	2,180	1486 32 2	

St Teräs **ZD** sinkitty, Deltatone 500

€/100 kpl

Voidaan lukita asennusputkien asennuksessa.



Muut palkkiinnikkeet



Kiinnityskappale, 24-28mm:n profiilikiskolle

Tyyppi	Kierre	Murto-kuorma kN	Pakk. kpl	Paino kg/100 kpl	Tuotenumero	Tuotenumero Snro
TKD 9	M6x9	0,22	100	1,100	1486 60 8	
TKD 16	M6x16	0,22	100	1,200	1486 61 6	
TKD 25	M6x25	0,22	100	1,400	1486 62 4	
TKD 38	M6x38	0,22	100	1,700	1486 63 2	

St Teräs **ZD** sinkitty, Deltatone 500 €/100 kpl
Alakattoprofiilikiskon kiinnityskappale.

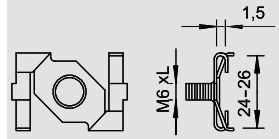

Mutteri

Tyyppi	Kierre	Murto-kuorma kN	Pakk. kpl	Paino kg/100 kpl	Tuotenumero	Tuotenumero Snro
TKD G	M6	0,22	100	0,540	1486 67 5	

St Teräs **ZD** sinkitty, Deltatone 500 €/100 kpl
Mutteri esim. kiinnityskappaleelle TKD.

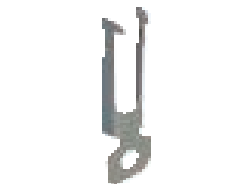
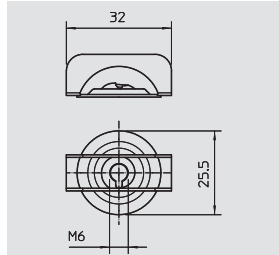

Kattokiinnike

Tyyppi	Pora-reikä Ø mm	Murto-kuorma kN	Pakk. kpl	Paino kg/100 kpl	Tuotenumero	Tuotenumero Snro
TKT	7	0,45	100	0,900	1486 86 1	

St Teräs **ZD** sinkitty, Deltatone 500 €/100 kpl
Kattokiinnike asennetaan 7mm:n reikään, kiinnityslevyn paksuus 0,8-2mm, 6,7mm:n kiinnitysreiällä.

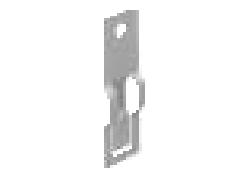
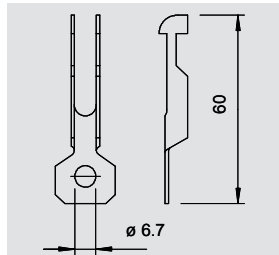

Kiinnityskappale

Tyyppi	Mitta B mm	Mitta L mm	Pakk. kpl	Paino kg/100 kpl	Tuotenumero	Tuotenumero Snro
TKA	25	79	100	1,300	1486 68 2	

St Teräs **ZD** sinkitty, Deltatone 500 €/100 kpl
Kiinnike kattokiskoille porarei'illä yleiskiinnitykseen

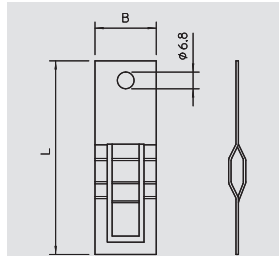

Kiinnityskappale

Tyyppi	Kierretankolle M	Kierretangolle m	Mitta B mm	Mitta L mm	Mitta G mm	Murto-kuorma kN	Pakk. kpl	Paino kg/100 kpl	Tuotenumero	Tuotenumero Snro
TK GS M4 M8	M4 - M8		19	82	M6	0,22	100	0,885	1486 69 4	
TK GS M10 M12	M10 - M12		26	120	M6	0,22	100	1,810	1486 69 8	

St Teräs **ZD** sinkitty, Deltatone 500 €/100 kpl
Kiinnike kierretankojen pikakiinnitykseen kattopalkkeihin.

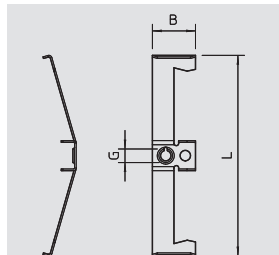

Palkkiinnike

Tyyppi	Laippa mm	Läh. laatikko Pari	Pakk. Pari	Paino kg/100 pari	Tuotenumero	Tuotenumero Snro
339 1	4-16	100		6,200	1408 51 8	

St Teräs €/100 pari
Kiinnitetään teräspalkkien laippoihin. Kiinnikkeissä M6-kierre asennuskiskon kiinnitystä varten.



Tyyppi	Laippa mm	Läh. laatikko Pari	Pakk. Pari	Paino kg/100 pari	Tuotenumero	Tuotenumero Snro
339 2	6-34	40		37,000	1408 53 4	

St Teräs €/100 pari
Kiinnitetään teräspalkkien laippoihin. Kiinnikkeissä M6-kierre asennuskiskon kiinnitystä varten.

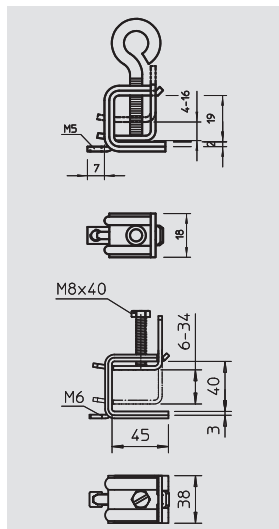

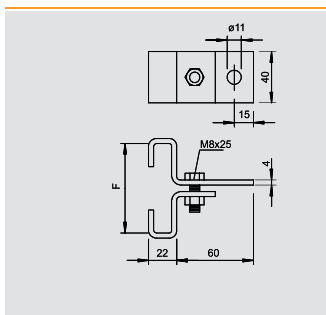

Palkkiinnike

Tyyppi	Laippa mm	Murto- kuorma kN	Läh. laatikko kpl	Pakk. kpl	Paino kg/100 kpl	Tuoteno	Tuoteno Snro
325 70 FT	70	10	25	25	27,900	5327 07 5	
325 80 FT	80	10	25	25	32,000	5327 08 3	
325 100 FT	100	9	25	25	33,500	5327 10 5	
325 130 FT	130	8	25	25	36,500	5327 12 1	
325 140 FT	140	7	25	25	40,000	5327 14 8	

St Teräs **FT** kuumasinkitty upottamalla DIN EN1461 40-60µm € /100 kpl

Palkkiinnike palkeille joiden laippamat 70-140mm, kiinnitysreillä.

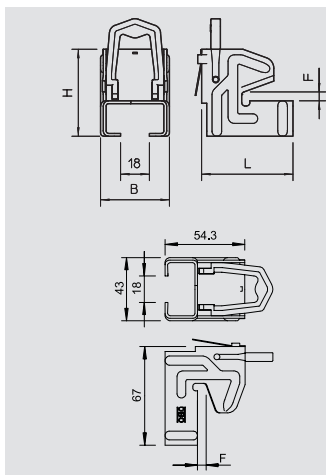

Palkkiinnike, asennuskiskolle 1268

Tyyppi	Laippa mm	Mitta L mm	Mitta B mm	Mitta H mm	Pakk. kpl	Paino kg/100 kpl	Tuoteno	Tuoteno Snro
328 1	5-11	57	39,5	54,3	50	10,800	1408 01 1	
328 2	10-19	67	39,5	54,3	50	12,500	1408 04 6	

St Teräs **ZD** sinkitty, Deltatone 500 € /100 kpl

Ruuviton palkkiinnike asennuskiskolle 1268. Kiinnitetään teräspalkkien laippoihin. Kiinnikkeissä asennuskiskon lukitusjousi.

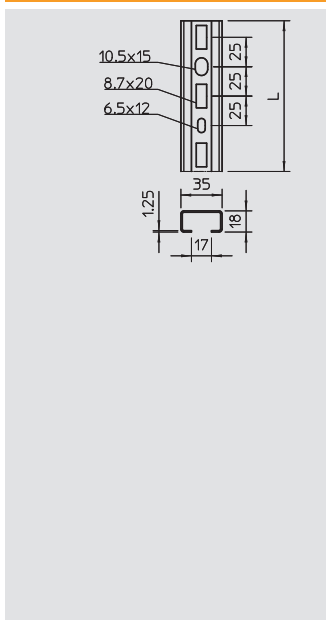
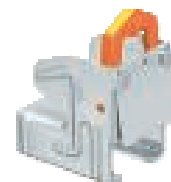

Asennuskisko 1,25 mm

Tyyppi	Ma- li	Pinta	Mitta B x H mm	Materiaalin paksuus mm	Pituus mm	Pakk. kpl	Paino kg/100 kpl	Tuoteno	Tuoteno Snro
1268 L 150 FS	re'iitetty	FS	35 x 18	1,25	150	25	10,730	1104 24 1	
1268 L 200 FS	re'iitetty	FS	35 x 18	1,25	200	25	14,300	1104 26 8	
1268 L 300 FS	re'iitetty	FS	35 x 18	1,25	300	25	21,450	1104 28 4	
1268 L 400 FS	re'iitetty	FS	35 x 18	1,25	400	10	28,550	1104 29 2	
1268 L 500 FS	re'iitetty	FS	35 x 18	1,25	500	10	35,750	1104 30 6	
1268 L 600 FS	re'iitetty	FS	35 x 18	1,25	600	10	42,900	1104 31 0	
1268 L 700 FS	re'iitetty	FS	35 x 18	1,25	700	10	50,050	1104 31 5	
1268 L 800 FS	re'iitetty	FS	35 x 18	1,25	800	10	57,200	1104 32 0	
1268 L 900 FS	re'iitetty	FS	35 x 18	1,25	900	10	64,350	1104 32 5	
1268 L 1M FS	re'iitetty	FS	35 x 18	1,25	1,000	10	71,500	1104 49 7	
1268 L 2M FS	re'iitetty	FS	35 x 18	1,25	2,000	20	71,500	1104 50 0	1462439

St Teräs **FS** kuumasinkitystä ohutlevystä DIN EN10327 ~20µm € /100 kpl

€ /100 m

Asennuskisko, re'iitetty, kevyt rakenne, rakoväli 17 mm.

Staattiset arvot:
 $A = 0,876 \text{ cm}^2$
 $I_y = 0,406 \text{ cm}^4$
 $I_z = 1,807 \text{ cm}^4$
 $W_y = 0,413 \text{ cm}^3$
 $W_z = 1,033 \text{ cm}^3$



Muut palkkiinnikkeet



Asennuskisko 1,75 mm

Tyyppi	Malli	Pinta	Mitta B x H mm	Materiaalin paksuus mm	Pituus mm	Pakk. kpl	Paino kg/100 kpl	Tuotenumro	Tuotenumro Snro
1268 SL 150 FS	rei'itetty	FS	35 x 18	1,75	150	25	15,000	1104 34 9	
1268 SL 200 FS	rei'itetty	FS	35 x 18	1,75	200	25	20,000	1104 35 7	
1268 SL 300 FS	rei'itetty	FS	35 x 18	1,75	300	25	30,000	1104 37 3	
1268 SL 400 FS	rei'itetty	FS	35 x 18	1,75	400	10	40,000	1104 39 1	
1268 SL 500 FS	rei'itetty	FS	35 x 18	1,75	500	10	50,000	1104 40 3	
1268 SL 600 FS	rei'itetty	FS	35 x 18	1,75	600	10	60,000	1104 41 1	
1268 SL 800 FS	rei'itetty	FS	35 x 18	1,75	800	10	80,000	1104 42 7	
1268 SL 900 FS	rei'itetty	FS	35 x 18	1,75	900	10	90,000	1104 43 5	
1268 SL 1M FS	rei'itetty	FS	35 x 18	1,75	1,000	10	100,000	1104 44 5	
1268 SL 2M FS	rei'itetty	FS	35 x 18	1,75	2,000	20	100,000	1104 45 4	

St Teräs FS kuumasinkitystä ohutlevystä DIN EN10327 ~20µm €/100 kpl
€/100 m

Asennuskisko, rei'itetty rakoväli 17 mm.

Staattiset arvot:
A = 1,172 cm²
I_y = 0,515 cm⁴
I_z = 0,526 cm⁴
W_y = 2,333 cm³
W_z = 1,333 cm³

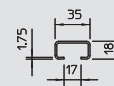
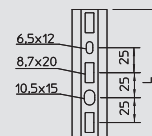

Päätysuoja

Tyyppi	Väri	Läh. laatikko kpl	Pakk. kpl	Paino kg/100 kpl	Tuotenumro	Tuotenumro Snro
1268 SK OR	oranssi	800	50	0,420	1124 50 2	

PE Polyeteeni €/100 kpl

Suojukset ehkäisevät loukkaantumisia. Sopii tyypeihin 1268 SL ja 1268 S/SL.

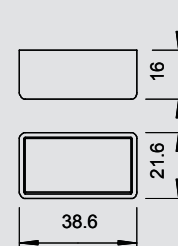

Muut kiinnitystarvikkeet

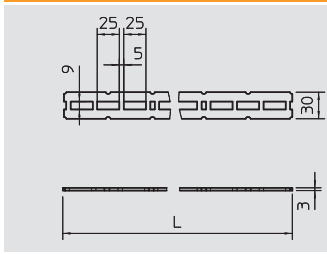

Kiinnitysvanne

Tyyppi	Pituus mm	Paino kg/100 m	Tuotenumero	Tuotenumero
			Snro	Snro
1268 SP 3M FT	3,000	55,000	6350 20 8	

St Teräs **FT** kuumasinkitty upottamalla DIN EN1461 40-60µm €/m
Teräslatta esim. ripustus- ja kiinnitystarkoituksiin.

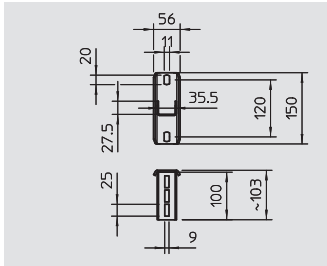

Kattokiinnike

Tyyppi	Pakk. kpl	Paino kg/100 kpl	Tuotenumero	Tuotenumero
			Snro	Snro
1268 KP FT	2	42,000	6350 05 4	

St Teräs **FT** kuumasinkitty upottamalla DIN EN1461 40-60µm €/kpl
Kattokiinnike asennuskiskolle 1268

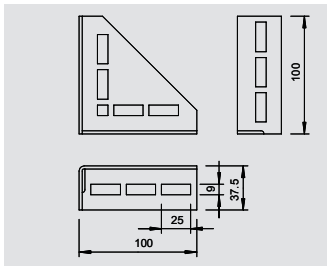

Kulmakappale

Tyyppi	Paino kg/100 kpl	Tuotenumero	Tuotenumero
		Snro	Snro
1268 KD FT	22,000	6350 10 0	

St Teräs **FT** kuumasinkitty upottamalla DIN EN1461 40-60µm €/kpl
Kulmakappale asennuskiskolle 1268

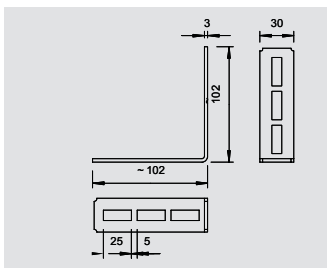

Kiinnityskappale 90°

Tyyppi	Pakk. kpl	Paino kg/100 kpl	Tuotenumero	Tuotenumero
			Snro	Snro
1268 W 90 G	2	11,000	6350 15 1	1464222

St Teräs **G** sinkitty DIN EN12329 2,5-10µm €/kpl
Kiinnityskappale asennuskiskolle 1268

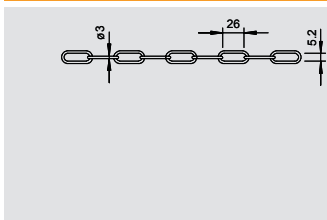
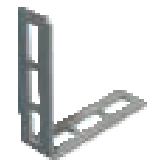

Ketju

Tyyppi	Murto- kuorma kN	Läh. laatikko m	Pakk. m	Paino kg/100 m	Tuotenumero	Tuotenumero
					Snro	Snro
K-C30 G	0,7	25	2	10,000	1488 20 1	

St Teräs **G** sinkitty DIN EN12329 2,5-10µm €/100 m
Käyttö esim. valaisimien ripustukseen.

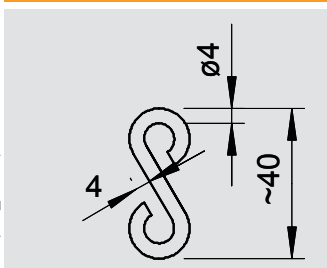

Koukku

Tyyppi	Murto- kuorma kN	Läh. laatikko kpl	Pakk. kpl	Paino kg/100 kpl	Tuotenumero	Tuotenumero
					Snro	Snro
SH 40 G	0,5	1,200	100	0,800	1488 25 2	

St Teräs **G** sinkitty DIN EN12329 2,5-10µm €/100 kpl
Käyttö esim. ketjuripustuksiin.

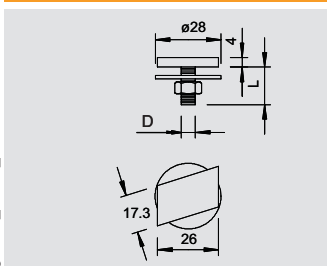

Liukuruuvi

Tyyppi	Kierre	Mitta L	Mitta D	Alus- levyn Ø	Laatu	Läh. laatikko kpl	Pakk. kpl	Paino kg/100 kpl	Tuotenumero	Tuotenumero
									Snro	Snro
5026 M6X20 G	M6	20	6	28,4,6		300	5	2,870	1151 70 3	
5026 M8X25 G	M8	25	8	28,4,6		300	50	3,320	1151 71 1	

St Teräs **G** sinkitty DIN EN12329 2,5-10µm €/100 kpl
Liukuruuvi aluslaatala ja mutterilla asennuskiskoille rakoväli 16 - 17 mm.



Muut kiinnitystarvikkeet

16-17



Liukumutteri

Tyyppi	Kierre	Mitta G	Mitta t	Maali	Läh. laatikko	Pakk. kpl	Paino kg/100 kpl	Tuoteno	Tuoteno Snro
5019 M6 OS G	M6	6	4	ilman ruuvia	1,200	100	1,150	1144 10 3	1464234
5019 M8 OS G	M8	8	5	ilman ruuvia	600	100	1,450	1144 11 1	1464233
5019 M10 OS G	M10	10	6	ilman ruuvia	600	100	1,650	1144 13 8	

St Teräs **G** sinkitty DIN EN12329 2,5-10µm €/100 kpl

Liukumutteri asennuskiskoille 16-17 mm:n rakoväli.

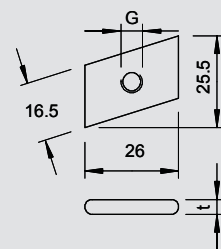

Aluslevy, suuri ulkohalkaisija

Tyyppi	Kierre	Mitta d	Mitta D	Mitta h	Läh. laatikko	Pakk. kpl	Paino kg/100 kpl	Tuoteno	Tuoteno Snro
967 M6 G	M6	6,5	28	2,5	1,000	100	1,150	3402 20 7	1464238
967 M8 G	M8	8,5	28	2,5	1,400	100	1,100	3402 21 5	
967 M10 G	M10	11	28	2,5	1,400	100	1,020	3402 22 3	

St Teräs **G** sinkitty DIN EN12329 2,5-10µm €/100 kpl

Aluslevy erittäin suurella ulkohalkaisijalla yleiskäyttöön.

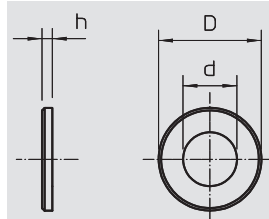

Aluslevy, DIN 125 muoto A

Tyyppi	Kierre	Mitta d	Mitta D	Mitta h	Läh. laatikko	Pakk. kpl	Paino kg/100 kpl	Tuoteno	Tuoteno Snro
966 M6 G	M6	6,4	12	1,6	12,000	100	0,114	3402 06 1	
966 M8 G	M8	8,4	16	1,6	5,000	100	0,214	3402 08 8	
966 M10 G	M10	10,5	20	2	3,000	100	0,408	3402 09 6	

St Teräs **G** sinkitty DIN EN12329 2,5-10µm €/100 kpl

Aluslevy DIN 125 mukaan muoto A yleiskäyttöön.

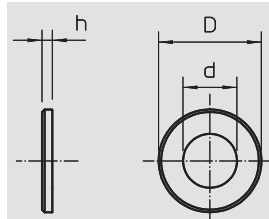

Mutteri

Tyyppi	Kierre	SW	Mitta h	Mitta d	Läh. laatikko	Pakk. kpl	Paino kg/100 kpl	Tuoteno	Tuoteno Snro
DIN 934 M6 G	M6	10	5,2	6	2,600	100	0,225	3400 06 9	
DIN 934 M8 G	M8	13	6,8	8	2,400	100	0,474	3400 08 5	
DIN 934 M10 G	M10	17	8,4	10	1,000	100	1,084	3400 10 7	

St Teräs **G** sinkitty DIN EN12329 2,5-10µm €/100 kpl

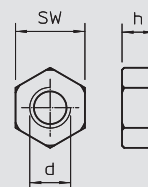

Mutteri DIN 934 mukaan metrisellä kierteellä.

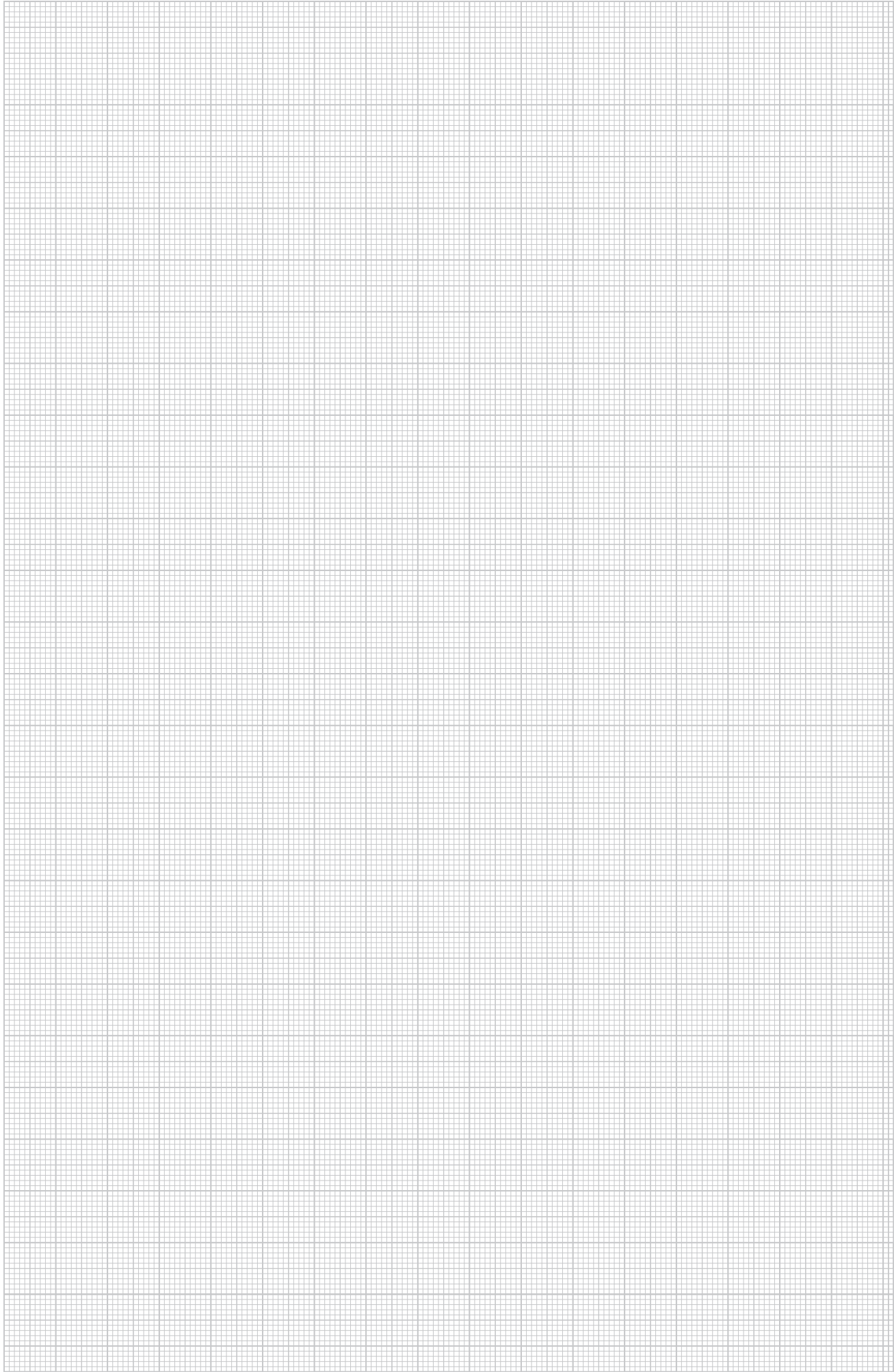





Sisällysluettelot

	Aakkosellinen sisällysluettelo	396
	Numeroluettelo	400
	Tyypiluettelo	412



A

A 11, 164
A 6, 164
A 8, 164
A 9, 164
Aluslevy, 392
Aluslevy, DIN 125 muoto A, 324
Aluslevy, suuri ulkohalkaisija, 324
Asennuskisko, 351
Asennuskisko 1,25 mm, 321
Asennuskisko 1,75 mm, 322
Asennuskisko, DIN-kisko, 350-351
Asennuskisko, MS 21, 336-337
Asennuskisko, MS 41, 337-340
Asennuskisko, rako 11 mm, 328-329
Asennuskisko, rako 12 mm, 329-330
Asennuskisko, rako 16 mm, 330
Asennuskisko, rako 16,5 mm, 331-332
Asennuskisko, rako 17 mm, 332-333
Asennuskisko, rako 18 mm, 333-334
Asennuskisko, rako 22 mm, 334-335
Asennuskisko, rako 7,5 mm, 328
Asennuskisko, T-sarja, 175
Asennuslevy, B 9/T, 167
Asennuslevy, T-sarja, 168, 174-175
Asennusputki Quick-Pipe putkikiinnikkeeseen, 312
Asennusputki Quick-Pipe, avattava, 311
Asennusputki, metalli, 304-305
Asennusputki, metalli, kierrepäillä, 304

B

B 10 M, kierreaihioin, 182
B 100 E, kytkentäliittimillä, 184
B 100 M, kalvotiivisteillä, 180
B 11 M, kierreaihioin, 182
B 12 M, kierreaihioin, 182
B 160 E, kytkentäliittimillä, 184
B 160 M, kalvotiivisteillä, 180
B 25 M, kalvotiivisteillä, 180
B 250 E, kiinnityskappaleella, 184
B 250 M, kalvotiivisteillä, 181
B 40 M, kalvotiivisteillä, 180
B 60 M, kalvotiivisteillä, 180
B 9/B M, kierreaihioin, 182
B 9/K M tyhjä, kierreaihioin, 182
B 9/T-jakorasia, lävistyskalvolla, 167
Betoniruuvi, 384-385

E

ECO 10, 10 ahiota, 166
ECO 12, 12 ahiota, 166
ECO 14, 14 ahiota, 166
ECO 18, 18 ahiota, 166
EMC-suojattu, M-kierre, 238

H

Hakanaula, 379
Holkkiruuvi, PG-kierre, 247
Holkkiruuvi, PK-kierre, 224
Holkkiruuvi, vedonpoistin PK-kierre, 225, 248
Holkkiruuvi, PK-kierre, 225
Holkkitiiviste ilman vedonpoistoa, M-kierre, 220, 239
Holkkitiiviste ilman vedonpoistoa, M-kierre,, 241-242 monikerrostiivisteellä
Holkkitiiviste ilman vedonpoistoa, M-kierre,, 243 pienireikäisellä tiivisteellä
Holkkitiiviste ilman vedonpoistoa, pitkä PK-kierre, 240
Holkkitiiviste ilman vedonpoistoa, PK-kierre, 219, 239-240
Holkkitiiviste ilman vedonpoistoa, PK-kierre pitkä, 244
Holkkitiiviste ilman vedonpoistoa, PK-kierre,, 244 isoreikäisellä tiivisteellä.

H

Holkkitiiviste ilman vedonpoistoa, PK-kierre,, 241-242 monikerrostiivisteellä
Holkkitiiviste ilman vedonpoistoa, PK-kierre,, 243 pienireikäisellä tiivisteellä
Holkkitiiviste lattakaapelille, PK-kierre, 221
Holkkitiiviste vedonpoistolla ja vääntösuojaalla, PK-kierre, 219
Holkkitiiviste vedonpoistolla, EX-suojattu muovia, M-, 211 kierre
Holkkitiiviste vedonpoistolla, EX-suojattu muovia, PK-, 210 kierre
Holkkitiiviste vedonpoistolla, EX-suojattu muovia, PK-, 210 kierre pitkä
Holkkitiiviste vedonpoistolla, M-kierre pitkä, 236
Holkkitiiviste vedonpoistolla, muovia, M-kierre lyhyt, 207
Holkkitiiviste vedonpoistolla, muovia, M-kierre pitkä, 207
Holkkitiiviste vedonpoistolla, muovia, PK-kierre, 208
Holkkitiiviste vedonpoistolla, muovia, PK-kierre lyhyt, 209
Holkkitiiviste vedonpoistolla, muovia, PK-kierre pitkä, 209
Holkkitiiviste vedonpoistolla, PK-kierre, 219, 237, 244-245
Holkkitiiviste vedonpoistolla, PK-kierre pitkä, 237
Holkkitiiviste vedonpoistolla, muovia, M-kierre, 206
Holkkitiiviste, EMC-suojattu kosketusliuskoilla, M-Kierre, 238
Holkkitiiviste, ilman vedonpoistoa, PK-kierre, 218
Holkkitiiviste, lattakaapelille, M-kierre, 220
Holkkitiiviste, lyhyt M-kierre, 216
Holkkitiiviste, M-kierre, 214-215, 217
Holkkitiiviste, pitkä PK-kierre, 216
Holkkitiiviste, PK-kierre, 214-215, 217
Holkkitiiviste, vedonpoistolla, M-kierre, 236

J

Jakorasia levyseinään, 196
Jakorasia uppoasennukseen, 189
Jakorasia uppoasennukseen kiinnityskorvakkeilla, 189
Jalkaruuvi, 386
Jatkokappale, 348
Jatkokappale 3 reiällä, 347
Jatkokappale 5 reiällä, 347
Jatkokappale, metalli, 308-309
Jatkokappale, T-muoto, 348
Jatkomuhvi Quick-Pipe, 311
Jatkomuhvi, metalli, 309
Jatkomuhvi, metalli, kierteillä, 307-308
Jatkomutteri, 386
Jatokappale 2 reiällä, 347
Jatokappale 4 reiällä, 347
Johdinside, 294
Jousialuslevy, 392

K

Kaapeli- ja putkikiinnike, 261, 270
Kaapeli- ja putkikiinnike, raskas, 290
Kaapeli- ja putkikiinnikkeet, 266
Kaapeli- ja putkikiinnikkeet ISO, 266, 269
Kaapeli- ja putkikiinnikkeet ISO, 1-osainen, 267
Kaapeli- ja putkikiinnikkeet ISO, 2-osainen, 266-267
Kaapeli- ja putkikiinnikkeet ISO, 3-osainen, 267
Kaapeli- ja putkikiinnikkeet ISO, ruuvikiinnitys, 269
Kaapeli- ja putkikiinnikkeet SOM, 1-osainen, 267-268
Kaapeli- ja putkikiinnikkeet SOM, 2-osainen, 268
Kaapelikiinnike, 261, 273, 287-288, 297, 373
Kaapelikiinnike 10 kaapelille, 264, 276
Kaapelikiinnike 16 kaapelille, 264, 276
Kaapelikiinnike 8 kaapelille, 264
Kaapelikiinnike Fix-ISO, 299
Kaapelikiinnike GRIP 10, 263
Kaapelikiinnike GRIP 20, 263
Kaapelikiinnike GRIP 40, 263
Kaapelikiinnike GRIP M15, 277
Kaapelikiinnike GRIP M30, 277
Kaapelikiinnike GRIP M70, 277

K

Kaapelikiinnike kiinnitystulpalla, 264
 Kaapelikiinnike lyöntitulpalla, 264
 Kaapelikiinnike, keskikokoinen, 288-290
 Kaapelikiinnike, keskikokoinen 20-28 mm, 286
 Kaapelikiinnike, keskikokoinen 5-18 mm, 286
 Kaapelikiinnike, kevyt, 285
 Kaapelikiinnike, metalli, 298
 Kaapelikiinnike, polystyreeni, 298
 Kaapelikiinnike, raskas, 287
 Kaapelikiinnike, vedonpoistin, 290-291
 Kaari 90° Quick-Pipe, 311
 Kaari, metalli, 306-307
 Kaari, metalli, kierrepäällä, 305-306
 Kaarikiinnike potentiaalintasausliittimenä, 356
 Kaarikiinnike, kahdelle kaapelille, metallivanne, 361, 363
 Kaarikiinnike, kahdelle kaapelille, muovivanne, 354-355, 359-360, 364, 367, 370
 Kaarikiinnike, kolmelle kaapelille, metallivanne, 362
 Kaarikiinnike, kolmelle kaapelille, muovivanne, 358-359, 365
 Kaarikiinnike, kolmelle yksijohdinkaapelille, 373
 Kaarikiinnike, maadoitusvanteiden kiinnitykseen, 363
 Kaarikiinnike, putkien kiinnitykseen, 363
 Kaarikiinnike, yhdelle kaapelille, metallivanne, 361-362, 366, 369, 372
 Kaarikiinnike, yhdelle kaapelille, muovivanne, 354-355, 360, 364-368, 370-371
 Kaarikiinnike, kahdelle kaapelille, muovivanne, 357
 Kaarikiinnike, yhdelle kaapelille, metallivanne, 356
 Kaarikiinnike, yhdelle kaapelille, muovivanne, 357-358
 Kaarikiinnikkeet, kolmelle yksijohdinkaapelille, 372
 Kaksoisnipa, 386
 Kaksoisvanne, metalli, 375
 Kaksoisvanne, muovi, 375
 Kalvotiiviste, 184
 Kalvotiiviste kaapeleille, T-sarja, 174
 Kalvotiiviste, B-sarja, 181
 Kalvotiiviste, kaapeleille ø 12 - 16 mm, A-sarja, 165
 Kalvotiiviste, kaapelin halkaisija 7 - 13 mm, A-sarja, 164
 Kalvotiiviste, M-kierre, 229
 Kalvotiiviste, PK-kierre, 230
 Kalvotiiviste, PK-kierre lävistyskalvolla, 230
 Kalvotiiviste, VBX-sarja, 168
 Kansi T-100, Modul 45 -pistorasiat, 179
 Kansiruuvi DIN 571, 391
 Kattokiinnike, 320, 323
 Kattokiinnike Rabitz, 387
 Ketju, 323
 Kevytbetonitulppa, 382
 Kierretanko, 386
 Kiila-ankkuri, 384
 Kiinnityskappale, 320, 336, 348-349
 Kiinnityskappale 1 reiällä, 347
 Kiinnityskappale 90°, 323
 Kiinnityskappale, 24-28mm:n profiilikiskolle, 320
 Kiinnityskappale, X-muoto, 347
 Kiinnityssvanne, 300
 Kiinnityssvanne, poimutettu, 300
 Kiinnitystarvike, ripustusvaijerit, 301
 Kiinnitystarvike, vaijerilukko, 299
 Kiinnitystulppa, 262
 Kiinnitystulppa johdinsiteille, 261
 Kiinnitysvanne, 283, 295-296, 323
 Kiinnitysvanne, muovipäällysteinen, 300
 Kiinnitysvanne, rullalla, 296
 Kiinnitysvanteen lukko, 295
 Kojerasia, 195
 Kojerasia levyseinään, 195-196
 Kojerasia oppoasennukseen, 188-189
 Kojerasia oppoasennukseen kiinnityskorvakkeilla, 188
 Kojerasia oppoasennukseen Modul 45, 1-mod., 194
 Kojerasia oppoasennukseen Modul 45, 2-mod., 194

K

Kojerasia oppoasennukseen Modul 45, 3-mod., 194
 Kojerasia, CEE, 193
 Kojerasia, Modul 45, 2-modulia, levyseinään, 197
 Kojerasia, Modul 45, 3-modulia, levyseinään, 197
 Kojerasia, Modul 45, 1½-modulia, levyseinään, 197
 Kojerasiat oppoasennukseen kiinnityskorvakkeilla, 189
 Kojeruuvi, 191
 Korotuskappale, 265, 276
 Korotusrengas 12 mm, jakorasiat, 191
 Korotusrengas 12 mm, kojerasiat, 191
 Korotusrengas 24 mm, jakorasiat, 191
 Korotusrengas 24 mm, kojerasiat, 191
 Koukku, 323, 387
 Koukku TS, 388
 Kulmakappale, 323
 Kulmakappale 90°, PK-kierre, 229
 Kuusioruuvi ISO 4017, 391
 Kytkentälaatta, A-sarja, 165
 Kytkentälaatta, B 9/T ja VBX-sarja, 168
 Kytkentälaatta, B-sarja, 181, 183
 Kytkentälaatta, T-sarja, 175
 Kytkentärima, ECO-sarja, 166
 Kytkentärimat, 10-napaiset molemmilta puolilta avoimet, 200
 Kytkentärimat, 12-napaiset, 201-202
 Kytkentärimat, 12-napaiset molemmilta puolilta avoimet, 200
 Kytkentärimat, 12-napaiset toiselta puolelta avoimet, 200
 Kytkentärimat, 12-napaiset, johdinsuoja, 201

L

Laajennus, M-kierre, 227, 248
 Laajennus, PK-kierre, 228, 249
 Levyankkuri, 382-383
 Levyseinäkiinnike, 382
 Liitäntärasia, 190
 Liitoskappale, L-muoto, 347
 Liukumutteri, 324
 Liukumutteri, rakoväli 11-12 mm, 341-342
 Liukumutteri, rakoväli 16-17 mm, 342
 Liukumutteri, rakoväli 18 mm, 342
 Liukumutteri, rakoväli 22 mm, 343
 Liukuruuvi, 323
 Liukuruuvi, MS 41:lle, 344
 Liukuruuvi, rakoväli 11-12 mm, 343
 Liukuruuvi, rakoväli 16-17 mm, 343-344
 Liukuruuvi, rakoväli 18 mm, 344
 Liukuruuvi, rakoväli 22 mm, 344
 Lyöntiankkuri, 383

M

Messinkiankkuri, 382
 Mutteri, 320, 324, 391
 Mutteri, starQuick, 260
 Muunnos M-PK, 228
 Muunnos PK-M, 228
 Muunnos, laajennus M - PK, 251
 Muunnos, laajennus PK - M, 252
 Muunnos, supistus M - PK, 251
 Muunnos, supistus PK - M, 252

N

N- ja PE-kiskot, 12-napaiset, 200
 N- ja PE-kiskot, 7-napaiset, 200
 Nailontulppa, 381
 Naulakiinnike, 271-272
 Naulakiinnike ilman naulaa, 271
 Naulakiinnike, Clip ISO, 272-273
 Naulakiinnike, ilman naulaa, 271
 Naulakiinnike, ISO, 271
 Naulatulppa, 265, 381
 Nysä, 188

Aakkosellinen sisällysluettelo

N

Nysä, T-sarja, 174

O

OBO -vaarna, 380

Ohenne, 297

P

Pääteholkki, M-kierre, 310

Pääteholkki, PK-kierre, 310

Päätysuoja, 322

Päätysuoja 1268, 333

Päätysuoja CPS 4, 334

Päätysuoja CPS 5, 336

Päätysuoja MS 21, 337

Päätysuoja MS 41, 340

Palkkikiinnike, 318, 320-321

Palkkikiinnike asennusputkille, 319

Palkkikiinnike läpireiällä, 319

Palkkikiinnike, asennuskiskolle 1268, 321

Palkkikiinnike, asennusnauhalle, 316

Palkkikiinnike, asennusputkille, 317-318

Palkkikiinnike, johdinsiteellä, 316

Palkkikiinnike, kierreireällä, 319

Palkkikiinnike, kierretangolle, 317

Palkkikiinnike, kierretapilla, 316

Palkkikiinnike, kiinnityskappaleella, 318

Palkkikiinnike, läpireikä, 316

Palkkikiinnike, nivelellä ja kierretangolla, 319

Palkkikiinnike, sisäkierteellä, 316

Palkkikiinnike, yleiskiinnike, 319

Patruuna Aquasit, 185

Patruunapistooli Aquasit, 185

Peitelevy CEE, 192

Pikaliima Impu-Fix nauhakaapeille, 297

Pölysuojalevy, metrinen, 212-213, 232, 254

Pölysuojalevy, PK, 213, 232-233, 254

Poranterä, 383

Puhelinnousurasia, 189

Puristinrenkas, PK-kierre, 253

Putkikiinnike, 261, 278-282, 284, 319

Putkikiinnike Multi-Quick, 259

Putkikiinnike Multi-Quick, metrinen, 259

Putkikiinnike Quick, 258

Putkikiinnike Quick, itsesammuva, 258

Putkikiinnike, 1-osainen, 269

Putkikiinnike, 2-osainen, 270

Putkikiinnike, ISO, 268

Putkikiinnike, luja malli M10, 283

Putkikiinnike, luja malli M6, 282

Putkikiinnike, luja malli M8, 283

Putkikiinnike, starQuick, 260

Puuruvi Sprint, ristiurakannalla, 390

Puuruvi, Golden Sprint, ristiurakannalla, 389

Puuruvi, Golden Sprint, Torx-urakannalla, 389

Puuruvi, Sprint Torx-urakannalla, 390

R

Rasiakansi, 190-192, 194, 196

Rasiakansi, 60 mm, 190

Rasiakansi, 70 mm, 190

Rasiakansi, 80 mm, 190

Rasialiittimet, 3-napaiset, 203

Rasialiittimet, 5-napaiset, 203

Rasialiittimet, 8-napaiset, 203

Rivikiinnike, rakoväli 11 - 12 mm, 345-346

Rivikiinnike, rakoväli 16 - 17 mm, 345

Rivikiinnike, rakoväli 7,5 mm, 344

Ruuisilmukka, 387

S

Sekoitusputki Aquasit, 185

Silmukka, 388

Silmukka TS, 388

Sulkutulppa, M- ja PK-kierre, 213

Sulkutulppa, M-kierre, 224, 247

Sulkutulppa, PK-kierre, 224, 247

Supistus, M-kierre, 226, 249

Supistus, PK-kierre, 227, 250

T

T 100 MSD, Modul 45 pistorasiat, 179

T 100 WB, Wieland-liittimillä, 176-178

T 100 ZE, vedonpoistimilla, 176

T 100, kalvotiiviste, 170

T 100, umpinaisilla sivuilla, 172

T 160, kalvotiiviste, 170

T 160, umpinaisilla sivuilla, 172

T 25, kalvotiiviste, 169

T 250, kalvotiiviste, 170

T 250, umpinaisilla sivuilla, 172

T 350, kalvotiiviste, 171

T 350, umpinaisilla sivuilla, 173

T 40 ZE, vedonpoistimilla, 176

T 40, kalvotiiviste, 169

T 40, umpinaisilla sivuilla, 172

T 60 ZE, vedonpoistimilla, 176

T 60, kalvotiiviste, 169

T 60, umpinaisilla sivuilla, 172

Tähtialuslevy, 391

Teräsnaula, 378

Teräsnaula Impu, 378

Teräsnaula, Siko, 379

Tiiviste, 230-231, 252

Tiiviste metrinen, 231-232

Tiiviste M-kierre, 254

Tiiviste PK-kierre, 254

Tiiviste PK-kierteelle, 232

Tiiviste, metrinen, 212, 231, 253

Tiiviste, PG, 231-232

Tiiviste, PK, 212, 232-233, 253, 255

Tiivistyskitti, 233

T-kappale Quick-Pipe, 312

T-kappaleet, 309

Tulppa, metalli, 382

Työkalu - vaijerileikkuri, 301

Työkalu, hylsy, 211

Työkalu, kiristyspihdit, 295-296

Työkalu, kiristyspihdit holkkitiivisteille, 212

Työkalu, kiskoleikkuri, 351

Työkalu, lyöntikara, 384

Työkalu, lyöntituurna, 380

Työkalu, putkileikkuri, 312

Työkalu, räikkäävain, 211

Työkalu, räikkäävainsarja, 211

V

Vaihtorasia, 183

Vaijeri, 298

Vaijerikaussi, 298

Vaijerilukko, 301

Vanttiruuvi, 298

Vastamutteri, M-kierre, 222-223, 246

Vastamutteri, PK-kierre, 222-223, 246

Vastavanne, metalli, 374

Vastavanne, muovi, 374

Vastavanne, muovi rakoväli 16-17mm, 374

VBX 25 M, kalvotiiviste IP54, 167

VBX 60 M, kalvotiiviste IP54, 167

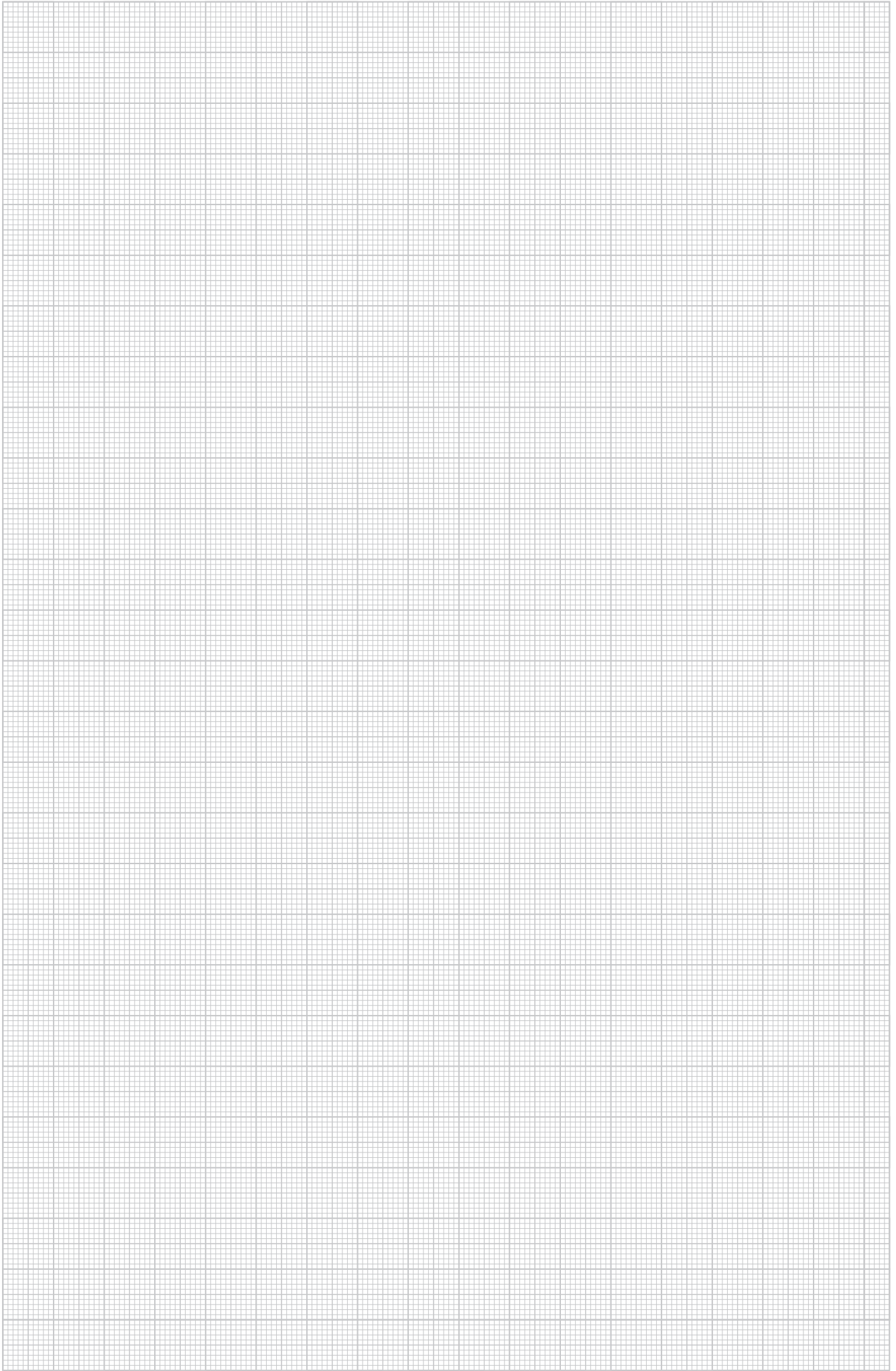

Numeroluettelo

EAN-numeron rakenne: maatunnus **40**

valmistajan tunnus **1219** (tuotenumeroille, jotka alkavat numerolla **0** pätee: **1010**)

yksilöllinen EAN-C **5647589**

EAN-C.	Tuoteno	Sida	snro-nr.	EAN-C.	Tuoteno	Sida	snro-nr.	EAN-C.	Tuoteno	Sida	snro-nr.	EAN-C.	Tuoteno	Sida	snro-nr.
5000792	1003 03 8	285		5016274	1018 07 8	289		5038658	1104 40 3	333		5046936	1118 02 1	331	
5000853	1003 04 6	285		5016335	1018 08 6	289		5038658	1104 40 3	322		5047056	1118 12 9	331	1463252
5000914	1003 05 4	285		5016397	1018 09 4	289		5486190	1104 41 1	333		5047179	1118 22 6	331	1463254
5000976	1003 06 2	285		5016458	1018 10 8	289		5486190	1104 41 1	322					
5001034	1003 07 0	285		5016519	1018 11 6	289		5051732	1104 42 7	333		5864318	1119 64 8	332	1462241
5001096	1003 08 9	285		5016571	1018 12 4	289		5051732	1104 42 7	322		5047599	1119 65 6	332	1462243
5001157	1003 09 7	285		5016632	1018 13 2	289		5052630	1104 43 5	322		5204138	1119 67 0	332	
5001218	1003 10 0	285		5016694	1018 14 0	289		5052630	1104 43 5	333		5053958	1119 67 2	332	
5001270	1003 11 9	285		5016755	1018 15 9	289									
5001331	1003 12 7	285		5016816	1018 16 7	289		5052692	1104 44 5	333		5056119	1119 67 5	332	
5001393	1003 13 5	285		5016878	1018 17 5	289		5052692	1104 44 5	322		5059295	1119 67 8	332	
5001454	1003 17 8	285		5016939	1018 18 3	289		5038719	1104 45 4	322		5059356	1119 68 1	332	
5001515	1003 19 4	285		5016991	1018 19 1	289		5038719	1104 45 4	333		5059417	1119 68 4	332	
5001577	1003 20 8	285		5017059	1018 20 5	289		5694458	1104 49 7	321		5060253	1119 68 7	332	
5001638	1003 21 6	285		5017110	1018 21 3	289		5694458	1104 49 7	332		5060376	1119 69 0	332	
5001690	1003 23 2	285		5017172	1018 22 1	289		5627074	1104 49 8	333		5060611	1119 69 3	332	
5566892	1003 25 9	285		5017233	1018 25 6	289		5038771	1104 50 0	332	1462439	5060673	1119 69 6	332	
5001751	1003 28 3	285		5017295	1018 26 4	289		5038771	1104 50 0	321	1462439				
5566953	1003 32 1	285		5017356	1018 28 0	289		5627081	1104 50 1	333		5047650	1119 70 2	332	
5001812	1003 35 6	285		5017417	1018 30 2	289						5047711	1119 72 9	332	
5001874	1003 37 2	285		5017479	1018 33 7	289		5039433	1105 12 4	328					
5001935	1003 40 2	285		5017530	1018 35 3	289		5627098	1105 12 5	329		5047773	1120 20 4	333	FI 1463210
5002055	1003 46 1	285		5017592	1018 36 1	289									
				5017653	1018 39 6	289		5039617	1106 02 3	328		5048732	1121 22 7	333	FI 1463211
5002833	1004 16 6	288		5017714	1018 43 4	289		5039730	1106 12 0	328	1339477				
5002895	1004 19 0	288		5017776	1018 47 7	289		5040095	1106 62 7	328		5672975	1121 24 3	334	
5003014	1004 21 2	288		5568339	1018 50 7	289		5627104	1106 62 8	328		5672555	1121 27 8	334	
5003137	1004 29 8	288		5017837	1018 55 8	289						5672494	1121 29 4	334	
				5017899	1018 60 4	289		5040453	1107 12 7	329	FI 1463202	5882251	1121 30 8	334	
5007456	1009 02 8	286		5568513	1018 63 9	289						5672616	1121 33 2	334	
5007517	1009 03 6	286						5040811	1108 12 3	329	1339478	5068310	1121 33 6	334	
5007579	1009 04 4	286		5028451	1043 01 3	287						5514572	1121 36 3	334	
5007630	1009 05 2	286		5028512	1043 02 1	287		5041412	1109 01 4	330					
5007692	1009 06 0	286		5028697	1043 06 4	287		5041474	1109 02 2	330	1463205	5745037	1121 39 1	334	
5007753	1009 07 9	286		5028758	1043 07 2	287		5041894	1109 52 9	329	1463201				
5007814	1009 08 7	286		5028819	1043 08 0	287						5886334	1121 40 5	334	
5007876	1009 10 9	286		5028871	1043 10 2	287		5036975	1109 78 2	330					
5007937	1009 11 7	286		5028932	1043 12 9	287		5037033	1109 79 0	330		5886211	1121 44 8	335	
5007999	1009 16 8	286		5028994	1043 14 5	287		5037095	1109 80 4	330		5049210	1121 46 4	335	FI 1462437
5008057	1009 18 4	286		5029052	1043 16 1	287		5037156	1109 81 2	330		5419686	1121 46 6	335	
5008118	1009 19 2	286		5029113	1043 19 6	287		5037217	1109 82 0	330		5462491	1121 47 2	335	FI 1462438
5008170	1009 20 6	286		5029175	1043 22 6	287		5037279	1109 83 9	330		5049272	1121 48 0	335	
5008231	1009 21 4	286		5029236	1043 24 2	287		5037330	1109 84 7	330		5049333	1121 49 9	335	
5008354	1009 23 0	286						5037392	1109 85 5	330		5049937	1121 89 8	334	FI 1462436
5008712	1009 36 2	286		5029595	1044 04 4	288						5049999	1121 90 1	334	
5009078	1009 42 7	286		5029717	1044 06 0	288		5037934	1109 86 3	330		5050179	1121 96 0	334	
				5029779	1044 07 9	288		5041771	1109 87 1	330		5050230	1121 97 9	334	FI 1462435
				5029830	1044 08 7	288									
5013631	1014 00 5	287		5029892	1044 10 9	288		5053897	1110 00 2	330		5697961	1122 47 9	339	
5013693	1014 01 3	287		5029953	1044 12 5	288		5042075	1110 00 4	330		5697978	1122 48 1	338	
5013754	1014 02 1	287		5030010	1044 14 1	288		5627111	1110 00 5	331		5050735	1122 48 3	339	
5013815	1014 04 8	287	1317160	5030072	1044 17 6	288						5050742	1122 48 7	339	
5013877	1014 09 9	287		5030133	1044 19 2	288		5043157	1112 02 3	331					
5013938	1014 11 0	287	1317161	5030195	1044 21 4	288		5043270	1112 12 0	331		5484516	1122 50 9	338	
5013990	1014 13 7	287		5030256	1044 23 0	288		5043393	1112 22 8	331		5485896	1122 51 7	338	
5014058	1014 16 1	287		5030317	1044 25 7	288		5632597	1112 70 8	331		5486251	1122 52 5	338	
5014119	1014 21 8	287						5627128	1112 70 9	331		5486794	1122 53 3	338	
5014171	1014 29 3	287						5632535	1112 75 9	331	1339810	5486916	1122 54 1	338	
5014232	1014 36 6	287										5487036	1122 56 8	338	
5567011	1014 50 1	287	1317162	5037873	1103 12 1	328		5044291	1115 05 7	351	1462229	5487098	1122 57 6	338	
5567073	1014 52 8	287	1317163					5044352	1115 06 5	351	1339479	5487159	1122 58 4	338	
5567134	1014 53 6	287						5044598	1115 33 2	351	1463209				
5567493	1014 54 4	287		5038238	1104 24 1	332		5044659	1115 35 9	351	1462228	5487272	1122 60 6	338	
5567554	1014 55 2	287		5038238	1104 24 1	321						5487876	1122 62 2	338	
				5038290	1104 26 8	332						5488170	1122 65 7	338	
5015130	1015 09 5	290		5038290	1104 26 8	321		5440987	1115 38 0	175	1627144				
5015192	1015 11 7	290		5038351	1104 28 4	321		5440994	1115 38 2	175	1627146				
5015253	1015 13 3	290		5038351	1104 28 4	332		5441007	1115 38 4	175	1627148	5686200	1122 90 0	340	
5015314	1015 16 8	290		5836353	1104 29 2	332		5441038	1115 38 6	175	1627149	5686217	1122 90 2	337	
5015376	1015 21 4	290		5836353	1104 29 2	321		5441045	1115 38 8	175	1627151				
5015437	1015 30 3	290		5038412	1104 30 6	332									
5015499	1015 36 2	290		5038412	1104 30 6	321		5044833	1115 42 1	350	FI 1463215	5697503	1122 90 8	337	
5015550	1015 42 7	290		5036678	1104 31 0	332		5044895	1115 45 6	350	1463216	5686224	1122 91 0	337	
5015611	1015 48 6	290		5036678	1104 31 0	321		5045076	1115 55 3	350		5686231	1122 91		

EAN-C.	Tuotenumero	Sida	snro-nr.	EAN-C.	Tuotenumero	Sida	snro-nr.	EAN-C.	Tuotenumero	Sida	snro-nr.	EAN-C.	Tuotenumero	Sida	snro-nr.
5697688	1122 93 6	336		5052579	1137 22 0	341	1463220	5058816	1153 62 5	344	FI 1463240	5064213	1159 61 5	360	
5697725	1122 93 7	336						5058878	1153 63 3	344	FI 1463241	5064275	1159 62 3	360	
5697732	1122 93 8	336		5052999	1140 01 9	342	FI 1339498	5058939	1153 64 1	344	FI 1463242	5668190	1159 71 2	362	
5697749	1122 93 9	336		5053057	1140 21 3	342	FI 1339499					5668206	1159 71 6	362	
5697787	1122 94 0	336						5483694	1154 40 3	344		5668213	1159 72 2	362	
5698081	1122 96 2	338		5053118	1141 05 8	341	1339483	5059714	1154 41 9	344	FI 1463243	5668220	1159 72 8	362	
5698098	1122 96 4	338		5053170	1141 06 6	341	1339484	5059776	1154 42 7	344	FI 1463244	5668268	1159 73 4	362	
5698104	1122 96 6	338		5053231	1141 10 4	341		5059837	1154 43 5	344	FI 1463245	5668275	1159 74 0	362	
5698142	1122 97 0	337						5060017	1154 60 5	344	FI 1463246	5668282	1159 74 6	362	
5698159	1122 97 2	337		5053293	1142 05 4	342		5060079	1154 61 3	344	FI 1463247	5668299	1159 75 2	362	
5698166	1122 97 4	337		5053354	1142 06 2	342		5060130	1154 62 1	344	FI 1463248	5668305	1159 75 8	362	
5698203	1122 97 8	339						5060192	1154 64 8	344	FI 1463249	5668312	1159 76 4	362	
5698210	1122 98 0	339		5053415	1143 06 9	342						5668329	1159 77 0	362	
5698227	1122 98 2	339		5119920	1143 12 3	342		5060857	1155 40 7	356	1339650	5668336	1159 77 6	362	
5698265	1122 98 8	339		5085980	1143 12 5	342		5060918	1155 41 5	356	1339651				
5698272	1122 99 0	339		5086017	1143 12 7	342		5060970	1155 42 3	356	1339652	5064459	1160 12 5	357	1339602
5698289	1122 99 2	339						5061038	1155 43 1	356	1339653	5064510	1160 16 8	357	1339603
				5053712	1144 10 3	342	1464234	5061090	1155 45 8	356	1339654	5064572	1160 22 2	357	1339604
				5053712	1144 10 3	324	1464234	5061151	1155 46 6	356	1339655	5064633	1160 28 1	357	1339605
				5053774	1144 11 1	324	1464233	5061212	1155 47 4	356	1339656	5064695	1160 34 6	357	1339606
				5053774	1144 11 1	342	1464233	5061274	1155 48 2	356	1339657	5064756	1160 40 0	357	1339607
				5053835	1144 13 8	342		5061335	1155 49 0	356	1339658	5064817	1160 45 1	357	1339608
				5053835	1144 13 8	324						5064879	1160 52 4	357	1339609
								5062714	1156 00 4	361	1339302	5064930	1160 58 3	357	1339610
				5445616	1146 45 1	343		5062776	1156 01 2	361	1339303	5064992	1160 64 8	357	1339611
				5445623	1146 45 5	343		5062837	1156 02 0	361	1339304	5065050	1160 70 2	357	1339612
				5445661	1146 45 9	343		5062899	1156 03 9	361	1339305	5065111	1160 76 1	357	1339613
				5445678	1146 46 3	343		5062950	1156 04 7	361	1339306	5065173	1160 82 6	357	1339614
				5054559	1146 50 5	342		5063018	1156 05 5	361	1339307	5065234	1160 90 7	357	1339615
				5054610	1146 51 3	342		5063070	1156 06 3	361	1339308	5065296	1160 99 0	357	1339616
				5054672	1146 52 1	342		5063131	1156 07 1	361	1339309				
				5084129	1146 55 6	342		5063193	1156 09 8	361	1339310	5065357	1161 12 1	357	1339617
				5084150	1146 55 8	342		5063254	1156 10 1	361	1339311	5065418	1161 16 4	357	1339618
				5084907	1146 56 0	342		5063315	1156 12 8	361		5065470	1161 22 9	357	1339619
				5084167	1146 56 2	342		5063377	1156 13 6	361		5065531	1161 28 8	357	1339620
				5054795	1146 60 2	343		5063438	1156 14 4	361		5065593	1161 34 2	357	1339621
				5054856	1146 61 0	343		5063490	1156 15 2	361		5065654	1161 40 7	357	1339622
				5054917	1146 62 9	343		5063551	1156 16 0	361		5065715	1161 46 6	357	1339623
				5054979	1146 63 7	343		5494836	1156 17 9	361		5065777	1161 52 0	357	1339624
				5084174	1146 64 6	343		5494898	1156 18 7	361		5065838	1161 57 1	357	1339625
				5084181	1146 64 8	343		5494959	1156 19 5	361		5065890	1161 64 4	357	
				5084211	1146 65 0	343		5958703	1156 20 9	361		5066071	1161 82 2	360	
				5084228	1146 65 2	343		5958765	1156 24 1	362		5066132	1161 83 0	360	
				5055037	1146 71 8	342		5958826	1156 26 8	362		5066194	1161 84 9	360	
				5055099	1146 72 6	342		5958888	1156 27 6	362		5066255	1161 85 7	360	
				5055150	1146 73 4	342		5958949	1156 28 4	362		5066316	1161 86 5	360	
				5055211	1146 74 2	342		5495192	1156 80 2	369		5066378	1161 87 3	360	
				5055273	1146 80 7	343		5495253	1156 81 0	369		5066439	1161 88 1	360	
				5055334	1146 81 5	343		5495314	1156 82 9	369		5066491	1161 90 3	360	
				5055396	1146 82 3	343		5495376	1156 83 7	369		5668343	1161 91 2	363	
												5668381	1161 91 6	363	
				5445685	1148 95 0	344		5498254	1158 00 7	366		5668398	1161 92 2	363	
				5445722	1148 95 5	344		5498315	1158 01 5	366		5668404	1161 92 8	363	
				5445739	1148 96 1	344		5498377	1158 02 3	366		5668442	1161 93 4	363	
				5445746	1148 96 6	344		5498438	1158 03 1	366		5668459	1161 94 0	363	
				5445784	1148 97 2	344		5498490	1158 05 8	366		5668466	1161 94 6	363	
								5498551	1158 06 6	366		5668503	1161 95 2	363	
				5055457	1149 00 8	343	FI 1339485	5498612	1158 07 4	366		5668510	1161 95 8	363	
				5055518	1149 01 6	343	FI 1339486	5498674	1158 08 2	366		5668527	1161 96 4	363	
				5055754	1149 21 0	343	FI 1339489	5498735	1158 09 0	366					
				5056171	1149 45 8	343		5498797	1158 10 4	366		5066972	1162 12 8	358	1339626
								5498858	1158 11 2	366		5067030	1162 16 0	358	1339627
				5056232	1150 01 4	343	FI 1339491	5498919	1158 12 0	366		5067092	1162 22 5	358	1339628
				5056478	1150 20 0	343	FI 1339494	5358411	1158 30 5	372	1339827	5067153	1162 28 4	358	1339629
				5056539	1150 21 9	343	FI 1339495	5358428	1158 30 9	372	1339828	5067214	1162 34 9	358	1339630
				5056713	1150 24 3	343	FI 1339497	5358435	1158 31 3	372	1339829	5067276	1162 40 3	358	1339631
				5056959	1150 45 6	343		5358442	1158 31 7	372	1339830	5067337	1162 46 2	358	1339632
								5358473	1158 32 1	372	1339831				
				5057017	1151 01 0	343	FI 1463221	5358480	1158 32 5	372	1339832	5067399	1163 12 4	354	1339560
				5057079	1151 02 9	343	FI 1463222	5358497	1158 32 9	372	1339833	5067450	1163 16 7	354	1339561
				5057253	1151 21 5	343	FI 1463225	5358503	1158 33 3	372	1339834	5067511	1163 22 1	354	1339562
				5057314	1151 22 3	343	FI 1463226	5358534	1158 33 7	372	1339835	5067573	1163 28 0	354	1339563
				5057437	1151 25 8	343	FI 1463228	5236597	1158 41 0	372	1339836	5067634	1163 34 5	354	1339564
				5057499	1151 40 1	343	FI 1463229	5236603	1158 41 4	372	1339837	5067696	1163 39 6	354	1339565
				5057550	1151 42 8	343	FI 1463230	5236610	1158 41 8	372	1339838	5067757	1163 46 9	354	1339566
				5057673	1151 44 4	343	FI 1463232	5236627	1158 42 2	372	1339839	5067818	1163 52 3	354	1339567
				5057796	1151 62 2	343	FI 1463233					5067870	1163 58 2	354	1339568
				5057918	1151 64 9	343	FI 1463235	5063612	1159 51 8	360		5067931	1163 64 7	354	1339569
				5057970	1151 70 3	323		5063674	1159 52 6	360		5067993	1163 70 1	354	1339570
				5057970	1151 70 3	344		5063735	1159 53 4	360					
				5058038	1151 71 1	344		5063797	1159 54 2	360		5068297	1164 12 0	354	1339580
				5058038	1151 71 1	323		5063858	1159 55 0	360		5068358	1164 16 3	354	1339581
								5063919	1159 56 9	360		5068419	1164 22 8	354	1339582

Numeroluettelo

EAN-numeron rakenne: maatumus 40

valmistajan tunnus 1219 (tuotenumeroille, jotka alkavat numerolla 0 pättee: 1010)

yksilöllinen EAN-C 5647589

EAN-C.	Tuotenumero	Sida	snro-nr.	EAN-C.	Tuotenumero	Sida	snro-nr.	EAN-C.	Tuotenumero	Sida	snro-nr.	EAN-C.	Tuotenumero	Sida	snro-nr.
5068716	1164 51 1	354	1339587	5074533	1177 45 1	365		5439219	1184 43 1	366	1339108	5083832	1197 82 7	374	1339334
5068778	1164 58 9	354	1339588					5439271	1184 45 8	366	1339110	5083894	1197 90 8	374	1339335
				5074595	1178 50 4	365		5439332	1184 46 6	366	1339112	5083955	1197 99 1	374	1339336
5069256	1166 01 8	355		5074656	1178 51 2	365		5439394	1184 47 4	366	1339114				
5069317	1166 02 6	355		5074717	1178 52 0	365		5439455	1184 48 2	366	1339116	5441434	1199 70 6	375	
5069379	1166 03 4	355		5074779	1178 53 9	365		5439516	1184 49 0	366	1339118	5441496	1199 71 4	375	
5069430	1166 04 2	355		5074830	1178 54 7	365		5439578	1184 50 4	366	1339120	5441557	1199 72 2	375	
5069492	1166 05 0	355		5074892	1178 55 5	365		5439639	1184 51 2	366	FI 1339124	5441618	1199 73 0	375	
5069553	1166 06 9	355		5074953	1178 56 3	365		5439752	1184 53 9	366	1339122	5441670	1199 74 9	375	
5069614	1166 07 7	355		5075011	1178 57 1	365		5440239	1184 70 9	368		5441731	1199 75 7	375	
5069676	1166 08 5	355		5075073	1178 59 8	365		5440291	1184 71 7	368		5442035	1199 84 6	374	1339312
5069737	1166 09 3	355		5075134	1178 60 1	365		5440352	1184 72 5	368		5442097	1199 85 4	374	1339313
5069799	1166 10 7	355		5075196	1178 62 8	365		5440413	1184 73 3	368		5442158	1199 86 2	374	1339314
				5075257	1178 63 6	365		5440475	1184 74 1	368		5442219	1199 87 0	374	1339315
								5440536	1184 76 8	368		5442271	1199 88 9	374	1339316
5432371	1167 00 6	356						5440598	1184 77 6	368		5442332	1199 89 7	374	1339317
5432432	1167 01 4	356		5075431	1180 12 6	370						5442394	1199 90 0	374	1339318
5432494	1167 02 2	356		5075493	1180 16 9	370		5077893	1185 00 4	368		5442455	1199 91 9	374	1339319
5432555	1167 03 0	356		5075554	1180 22 3	370		5077954	1185 01 2	368		5442516	1199 92 7	374	1339320
5432616	1167 04 9	356		5075615	1180 28 2	370		5078012	1185 02 0	368		5442578	1199 93 5	374	1339321
				5075677	1180 34 7	370		5078074	1185 03 9	368		5442639	1199 94 3	374	
5070634	1169 12 2	367		5075738	1180 40 1	370		5078135	1185 04 7	368					
5070696	1169 16 5	367		5075790	1180 46 0	370		5078197	1185 05 5	368		5105978	1310 61 5	284	
5070757	1169 21 1	367		5075851	1180 52 5	370		5078258	1185 06 3	368		5106036	1310 65 8	284	
5070818	1169 28 9	367		5075912	1180 58 4	370		5078319	1185 07 1	368		5106159	1310 92 5	288	
5070870	1169 34 3	367		5075974	1180 64 9	370		5078371	1185 09 8	368					
5070931	1169 40 8	367		5076032	1180 68 1	370		5078432	1185 10 1	368		5114499	1360 05 1	278	
5070993	1169 46 7	367		5076094	1180 76 2	370		5079392	1185 43 8	371		5114550	1360 08 6	278	
5071051	1169 52 1	367		5076155	1180 82 7	370		5079453	1185 44 6	371		5114611	1360 10 8	278	
5071112	1169 58 0	367		5076216	1180 90 8	370		5079514	1185 45 4	371		5114673	1360 12 4	278	
5071174	1169 64 5	367						5079576	1185 46 2	371		5114734	1360 14 0	278	
5071235	1169 69 6	367		5076339	1181 12 2	370		5079637	1185 47 0	371		5114796	1360 15 9	278	
5071297	1169 76 9	367		5076391	1181 16 5	370	1339132	5079699	1185 48 9	371		5114857	1360 16 7	278	
5071358	1169 82 3	367		5076452	1181 21 1	370		5079750	1185 49 7	371		5114918	1360 18 3	278	
5071419	1169 90 4	367		5076513	1181 28 9	370						5114970	1360 20 5	278	
				5076575	1181 34 3	370		5033073	1193 70 8	363		5115038	1360 22 1	278	
5071532	1170 12 0	367		5076636	1181 40 8	370		5033134	1193 71 6	363		5115090	1360 24 8	278	
5071594	1170 16 3	367	1339130	5076698	1181 46 7	370		5033196	1193 72 4	363		5115151	1360 26 4	278	
5071655	1170 22 8	367		5076759	1181 52 1	370		5033257	1193 73 2	363		5115212	1360 28 0	278	
5071716	1170 28 7	367		5076810	1181 58 0	370		5033318	1193 74 0	363		5115274	1360 30 2	278	
5071778	1170 34 1	367						5033370	1193 75 9	363		5115335	1360 33 7	278	
5071839	1170 40 6	367		5077299	1183 20 6	358	1339152	5033431	1193 76 7	363		5115397	1360 35 3	278	
5071891	1170 46 5	367		5077350	1183 21 4	358	1339154					5115458	1360 38 8	278	
5071952	1170 51 1	367		5077411	1183 22 2	358	1339156	5081197	1194 04 6	373	FI 1463218	5115519	1360 39 6	278	
				5077473	1183 23 0	358	1339158	5081258	1194 05 4	373	1463217	5115571	1360 42 6	278	
5072492	1174 05 3	363		5077534	1183 24 9	358	1339160	5081319	1194 08 9	373	FI 1463219	5115632	1360 45 0	278	
5451211	1174 50 9	373		5077596	1183 25 7	358	1339162	5476771	1194 37 2	373		5115694	1360 48 5	278	
5451273	1174 51 7	373		5077657	1183 26 5	358	1339164					5115755	1360 50 7	278	
5451334	1174 52 5	373		5077718	1183 27 3	358	1339166					5115878	1360 60 4	278	
5072553	1174 54 1	373		5077770	1183 28 1	358	1339168	5081371	1195 12 3	374		5115939	1360 35 3	278	
5072614	1174 56 8	373		5077831	1183 30 3	358	1339170	5081432	1195 16 6	374		5569114	1360 63 9	278	
5072676	1174 57 6	373		5435310	1183 31 1	358	1339172	5081494	1195 22 0	374					
5500353	1174 60 6	372		5435372	1183 33 8	358	1339174	5081555	1195 27 1	374		5029755	1361 09 1	280	
5500414	1174 61 4	372		5435495	1183 38 9	359	1339202	5081616	1195 34 4	374		5029762	1361 09 4	280	
5500476	1174 63 0	372		5435556	1183 39 7	359	1339204	5081678	1195 40 9	374		5029809	1361 09 7	280	
				5435617	1183 40 0	359	1339206	5081739	1195 46 8	374		5029816	1361 10 0	280	
5072737	1175 12 2	364		5435679	1183 41 9	359	1339208	5081791	1195 52 2	374		5029823	1361 10 3	280	
5072799	1175 16 5	364		5435730	1183 42 7	359	1339210	5081852	1195 58 1	374		5029861	1361 10 6	280	
5072850	1175 21 1	364		5435792	1183 43 5	359	1339212	5081913	1195 64 6	374		5029878	1361 10 9	280	
5072911	1175 28 9	364		5435853	1183 44 3	359	1339214	5081975	1195 70 0	374		5029885	1361 11 2	280	
5072973	1175 34 3	364		5435914	1183 45 1	359	1339216					5254348	1361 11 5	280	
5073031	1175 40 8	364		5435976	1183 47 8	359	1339218	5082576	1196 11 1	375	1339337	5615651	1361 11 7	280	
5073093	1175 46 7	364		5436218	1183 52 4	359	1339256	5082637	1196 16 2	375	1339338	5254386	1361 11 8	280	
5073154	1175 52 1	364		5436270	1183 53 2	359	1339258	5082699	1196 22 7	375	1339339	5115939	1361 13 9	279	1339458
5073215	1175 58 0	364		5436331	1183 54 0	359	1339260	5082750	1196 28 6	375	1339340	5115991	1361 16 3	279	1339459
5073277	1175 64 5	364		5436515	1183 60 5	355	1339687	5082811	1196 34 0	375	1339341	5116059	1361 19 8	279	1339460
5073338	1175 69 6	364		5436577	1183 61 3	355	1339688	5082873	1196 40 5	375	1339342	5116110	1361 20 1	279	1339461
5073390	1175 76 9	364		5436638	1183 62 1	355	1339689	5082934	1196 46 4	375	1339343	5116172	1361 23 6	279	1339462
5073451	1175 82 3	364		5436690	1183 64 8	355	1339690	5082996	1196 52 9	375	1339344	5116233	1361 29 5	279	1339463
5073512	1175 90 4	364		5436751	118										

EAN-C.	Tuoteno	Sida	snro-nr.	EAN-C.	Tuoteno	Sida	snro-nr.	EAN-C.	Tuoteno	Sida	snro-nr.	EAN-C.	Tuoteno	Sida	snro-nr.
5450498	1362 56 9	280	1317529	5135555	1442 01 5	291		5144496	1483 57 9	316		5151630	2000 09 1	164	
5450559	1362 57 7	280	1317538					5144557	1483 58 7	316		5820390	2000 16 4	164	
5450610	1362 58 5	280	1317548	5135616	1443 01 1	291		5144618	1483 59 5	316		5707899	2000 18 0	164	
5450672	1362 59 3	280	1317554									5152057	2000 32 6	164	
5590293	1362 61 5	280						5144670	1484 00 1	317	1317720	5152170	2000 34 2	164	
				5136811	1465 10 4	296		5144731	1484 02 8	317					
5117919	1366 12 2	281		5136934	1465 14 7	296		5144793	1484 03 6	317	1317732	5507079	2001 00 0	166	
5117971	1366 16 5	281		5136996	1465 16 3	296		5144854	1484 07 9	317		5507130	2001 00 6	166	
5118039	1366 20 3	281		5137054	1465 19 8	296		5144915	1484 08 7	317	1317721	5507192	2001 00 7	166	
5118091	1366 25 4	281		5549079	1465 60 0	296		5144977	1484 09 5	317	1317733	5507253	2001 01 2	166	
5118152	1366 30 0	281		5137597	1465 76 7	296		5145035	1484 13 3	317	1317722	5507673	2001 01 3	166	
5118213	1366 35 1	281		5137658	1465 77 5	296		5145097	1484 14 1	317		5508212	2001 01 8	166	
5118275	1366 62 9	281		5137719	1465 79 1	296		5145158	1484 16 8	317	1317734	5508458	2001 01 9	166	
5118336	1366 66 1	281		5137771	1465 80 5	296		5145219	1484 30 3	317		5532392	2001 03 0	166	1627110
				5137832	1465 82 1	296		5145271	1484 31 1	317		5532453	2001 03 3	166	1627112
5120735	1380 02 8	281						5145332	1484 33 8	317		5532514	2001 03 6	166	1627114
5120858	1380 22 2	281		5137955	1466 26 7	296		5145394	1484 34 6	317		5532576	2001 03 9	166	FI 1627152
5120971	1380 42 7	281						5145455	1484 40 0	317		5249795	2001 05 5	164	
5121152	1380 72 9	281						5145516	1484 41 9	317		5125655	2001 12 8	180	
				5138310	1470 12 4	300		5145578	1484 42 7	317		5545415	2001 13 6	180	
5121336	1383 09 4	282		5138372	1470 17 5	300		5145639	1484 43 5	317		5545231	2001 16 0	180	
5121398	1383 11 6	282		5138433	1470 26 4	300		5145691	1484 50 8	317		5545170	2001 17 9	180	
5121459	1383 13 2	282						5145752	1484 51 6	317		5545118	2001 20 9	180	
5121510	1383 16 7	282		5138679	1471 12 0	300	1317459	5145813	1484 52 4	317		5119838	2001 21 7	180	
5121572	1383 21 3	282		5138730	1471 17 1	300		5145936	1484 70 2	319		5117735	2001 24 1	180	FI 1627130
5121633	1383 29 9	282		5138792	1471 26 0	300		5145998	1484 81 8	319		5542537	2001 26 8	180	1627118
5569176	1383 31 0	282						5146056	1484 82 6	319		5542476	2001 29 2	180	FI 1627140
5121695	1383 36 1	282		5139393	1473 22 0	300		5146117	1484 83 4	319		5542414	2001 30 6	180	FI 1627132
5569237	1383 41 8	282		5139454	1473 27 1	300		5146179	1484 84 2	319		5542353	2001 33 0	181	FI 1627150
5121756	1383 42 6	282		5139515	1473 36 0	300						5542292	2001 34 9	181	FI 1627142
5121817	1383 48 5	282						5146353	1485 10 5	318		5536239	2001 61 6	182	
5569299	1383 50 7	282		5139935	1475 12 6	300		5146414	1485 11 3	318		5536178	2001 63 2	182	
				5139997	1475 17 7	300						5541936	2001 84 5	167	
5122838	1385 00 3	282		5140054	1475 26 6	300		5148210	1486 30 6	319		5540076	2001 85 3	167	
5122890	1385 01 1	282		5140115	1475 62 2	300		5148272	1486 31 4	319		5539896	2001 86 1	167	
5122951	1385 03 8	282		5140177	1475 67 3	300		5148333	1486 32 2	319		5110477	2001 88 8	167	
5123019	1385 05 4	282		5140238	1475 76 2	300		5148753	1486 60 8	320		5536116	2001 94 2	182	
5123071	1385 06 2	282						5148814	1486 61 6	320					
5123132	1385 08 9	282						5148876	1486 62 4	320		5107712	2002 14 0	182	
5123194	1385 11 9	282		5140474	1481 01 0	316	1317602	5148937	1486 63 2	320		5107651	2002 16 7	182	
5123255	1385 12 7	282		5140535	1481 02 9	316	1317605	5148999	1486 67 5	320		5107590	2002 32 9	182	
5123316	1385 13 5	282		5140658	1481 04 5	316	1317614	5407098	1486 68 2	320		5105435	2002 34 5	182	
				5407027	1481 10 2	316		5407089	1486 69 4	320		5105374	2002 50 7	182	
5123675	1387 01 4	283		5407034	1481 10 8	316		5407102	1486 69 8	320		5105312	2002 52 3	182	
5123736	1387 03 0	283		5407041	1481 11 4	316		5149231	1486 86 1	320		5445791	2002 57 1	184	1627190
5123798	1387 05 7	283		5407072	1481 12 0	316						5445807	2002 57 8	184	1627191
5123859	1387 06 5	283		5140719	1481 20 7	318		5149477	1487 00 0	318		5445845	2002 58 5	184	1627192
5123910	1387 08 1	283		5140771	1481 21 5	318		5149538	1487 01 9	318					
5123972	1387 11 1	283		5140894	1481 23 1	318		5149590	1487 02 7	318		5000204	2003 01 5	188	
5124030	1387 13 8	283		5140955	1481 40 1	316	1317607	5149651	1487 03 5	318	1317751	5002314	2003 01 9	188	
5124092	1387 15 4	283		5141013	1481 42 8	316		5149712	1487 04 3	318	1317752	5003571	2003 02 3	188	
5124153	1387 17 0	283		5141075	1481 45 2	316	1317609	5149774	1487 05 1	318	1317753	5003694	2003 03 1	188	
				5141136	1481 46 0	316		5149835	1487 07 8	318	FI 1317754	5013457	2003 03 5	189	
5124450	1388 03 7	283		5141310	1481 53 3	316		5149897	1487 20 5	318		5013518	2003 04 3	189	
5124511	1388 05 3	283		5141372	1481 54 1	316		5149958	1487 21 3	318		5013570	2003 04 7	189	
5124573	1388 06 1	283		5141433	1481 70 3	316		5150015	1487 22 1	318		5018254	2003 05 8	189	
5124696	1388 11 8	283		5141495	1481 71 1	316		5150077	1487 24 8	318	1317761	5022633	2003 08 2	190	
5124757	1388 13 4	283		5141617	1481 74 6	316		5150138	1487 25 6	318	1317762	5020479	2003 11 2	189	
5544814	1388 37 1	283						5150190	1487 26 4	318	1317763	5023715	2003 11 8	189	
5544876	1388 39 8	283		5142096	1482 06 8	317		5150251	1487 27 2	318	1317764	5023777	2003 12 4	189	
5544937	1388 42 8	283		5142157	1482 07 6	317		5150312	1487 41 8	318		5023951	2003 13 0	189	1627177
				5142218	1482 08 4	317	1317650	5150374	1487 42 6	318		5024071	2003 13 6	189	1156002
				5142270	1482 11 4	317		5150435	1487 43 4	318		5021377	2003 21 2	188	
5125891	1404 16 4	298		5142331	1482 12 2	317		5150497	1487 44 2	318	1317771	5024132	2003 21 8	190	
5125952	1404 18 0	298		5142638	1482 40 8	317		5150558	1487 45 0	318	1317772	5024194	2003 22 3	190	
5126010	1404 28 8	298		5142690	1482 41 6	317		5150619	1487 46 9	318	1317773	5024255	2003 22 7	190	
				5142812	1482 46 7	317		5150671	1487 47 7	318	1317774	5024316	2003 23 6	190	
5126799	1408 01 1	321		5142874	1482 47 5	317		5407133	1487 49 6	318		5024316	2003 23 6	190	
5126850	1408 04 6	321		5142935	1482 48 3	317		5150732	1487 70 1	318		5024378	2003 24 0	191	
				5143178	1482 60 2	317		5150794	1487 72 8	318		5024439	2003 24 4	191	
5126973	1408 51 8	320		5143239	1482 61 0	317						5024491	2003 24 8	191	
5127031	1408 53 4	320		5143291	1482 62 9	317		5150855	1488 01 5	319	1339801	5025276	2003 25 2	191	
								5150916	1488 02 3	319	1339802	5025337	2003 25 6	191	
5134831	1435 01 9	290		5143352	1483 01 3	317		5150978	1488 03 1	319	1339803	5025399	2003 26 5	191	
5134893	1435 02 7	290		5143413	1483 02 1	317		5151036	1488 07 4	319	FI 1339808	5025450	2003 26 9	191	
				5143475	1483 04 8	317		5151098	1488 08 2	319	FI 1339810	5027676	2003 27 3	191	
5134954	1436 01 5	291		5143536	1483 05 6	317		5151159	1488 09 0	319	FI 1339812	5027737	2003 27 7	191	
5135012	1436 02 3	291		5143598	1483 10 2	317		5407140	1488 11 1	319		5027911	2003 28 7	191	
				5143659	1483 11 0	317						5027973	2003 29 1	191	
5135074	1437 00 3	291		5143710	1483 12 9	317		5151210	1488 20 1	323		5			

Numeroluettelo

EAN-numeron rakenne: maatumnus 40

valmistajan tunnus 1219 (tuotenumeroille, jotka alkavat numerolla 0 pättee: 1010)

yksilöllinen EAN-C 5647589

EAN-C.	Tuoteno	Sida	snro-nr.	EAN-C.	Tuoteno	Sida	snro-nr.	EAN-C.	Tuoteno	Sida	snro-nr.	EAN-C.	Tuoteno	Sida	snro-nr.
5032830	2003 42 2	195	1156007	5126430	2008 56 4	167		5160755	2022 61 3	208		5839538	2024 28 4	209	
5051350	2003 42 6	195		5160816	2022 62 1	208		5839590	2024 29 2	209		5839651	2024 30 6	209	
5032892	2003 43 0	196		5456018	2008 97 1	168	FI 1462165	5160878	2022 64 8	208		5839712	2024 31 4	209	
5032953	2003 44 2	196						5160939	2022 65 6	208		5839774	2024 32 2	209	
5033011	2003 44 9	196						5160991	2022 66 4	208		5839835	2024 33 0	209	
5246725	2003 60 3	195		5448990	2009 10 2	175	1627172	5161059	2022 67 2	208		5839897	2024 34 9	209	
5246732	2003 61 1	195		5448990	2009 10 2	168	1627172	5161110	2022 68 0	208		5839958	2024 35 7	209	
5246749	2003 61 9	196		5449058	2009 11 0	168	1627173	5161172	2022 69 9	208		5840015	2024 36 5	209	
				5449058	2009 11 0	175	1627173	5161233	2022 70 2	208		5840077	2024 37 3	209	
5291909	2004 63 4	190						5532637	2022 84 3	206		5446774	2024 70 5	208	1711007
5292319	2004 67 6	191		5246909	2011 50 6	174	1627169	5532699	2022 84 5	206		5446835	2024 71 3	208	1711009
5292371	2004 68 0	191		5246916	2011 51 4	174	1627170	5532750	2022 84 7	206		5446897	2024 72 1	208	1711011
				5246923	2011 52 2	174		5532811	2022 84 9	206		5446958	2024 74 8	208	1711013
5246770	2007 02 9	169		5246930	2011 53 0	174		5532934	2022 85 1	206		5447016	2024 75 6	208	1711016
5246756	2007 04 5	169		5246947	2011 53 8	174		5532996	2022 85 3	206		5447078	2024 76 4	208	1711021
5246787	2007 06 1	169		5246954	2011 54 6	174		5533054	2022 85 5	206		5447139	2024 77 2	208	1711029
5246794	2007 07 7	170	5246961	2011 63 8	174	1627163	5533115	2022 85 7	206		5447191	2024 78 0	208	1711036	
5470632	2007 08 1	170	5246978	2011 64 6	174	1627164	5533177	2022 86 2	206	FI 1711112	5447252	2024 79 9	208	1711048	
5246800	2007 09 3	170	5246985	2011 65 4	174	1627165	5533238	2022 86 4	206	FI 1711116	5447313	2024 80 2	208	1711048	
5470649	2007 09 7	170	5303206	2011 68 9	174	1627166	5533658	2022 86 6	206	FI 1711120	5502456	2024 82 9	207		
5246817	2007 10 9	170	5303213	2011 69 7	174	1627167	5533719	2022 86 8	206	FI 1711125	5313458	2024 86 1	209		
5246824	2007 12 5	171	5303220	2011 70 0	174	1627168	5533771	2022 87 0	206	FI 1711132					
5246831	2007 22 3	172					5533832	2022 87 2	206	FI 1711140					
5246848	2007 23 9	172					5533894	2022 87 4	206	FI 1711150	5162971	2025 07 8	224		
5246855	2007 25 5	172	5156079	2012 03 0	164		5533955	2022 87 6	206	FI 1711163	5163039	2025 09 4	224		
5246862	2007 27 1	172	5156130	2012 04 9	165		5534013	2022 88 3	206		5163091	2025 11 6	224		
5246879	2007 28 7	172	5105251	2012 37 5	168		5534013	2022 88 3	206		5163152	2025 13 2	224		
5246886	2007 30 3	173	5105251	2012 37 5	181		5535638	2022 88 5	206		5163213	2025 16 7	224		
5286486	2007 31 2	169	5105190	2012 38 3	168		5535690	2022 88 7	206		5163275	2025 21 3	224		
5286493	2007 32 0	169	5105190	2012 38 3	181		5535751	2022 88 9	206		5163336	2025 29 9	224		
5286509	2007 33 9	169	5105138	2012 39 1	181	1627175	5538219	2022 89 1	206		5163398	2025 36 1	224		
5286547	2007 34 7	170	5105138	2012 39 1	168	1627176	5538332	2022 89 3	206		5163459	2025 42 6	224		
5286554	2007 35 5	170	5651727	2012 70 9	184		5538455	2022 89 5	206		5163510	2025 48 5	224		
5286561	2007 36 3	170	5651734	2012 73 3	184		5538516	2022 89 7	206		5163695	2025 53 1	225		
5286608	2007 37 1	171	5156734	2012 75 8	221		5003786	2022 92 1	207		5163756	2025 56 6	225		
5441052	2007 40 8	169	5156857	2012 77 4	221		5003823	2022 92 4	207		5163879	2025 60 4	225		
5441069	2007 41 0	169	5156918	2012 78 2	221		5003885	2022 92 6	207		5163992	2025 64 7	225		
5441090	2007 41 2	169	5156970	2012 80 4	221		5003908	2022 92 8	207						
5441106	2007 41 4	170	5157038	2012 82 0	221		5003946	2022 93 0	207		5164777	2027 07 0	253		
5441113	2007 41 6	170	5157090	2012 83 9	221		5004004	2022 93 3	207		5164838	2027 09 7	253		
5441120	2007 41 8	170	5157151	2012 84 7	221		5004028	2022 93 5	207		5164890	2027 11 9	253		
5441151	2007 42 0	171	5157212	2012 85 5	221		5004066	2022 93 7	207		5164951	2027 13 5	253		
5441168	2007 43 0	169	5157335	2012 87 1	221		5004127	2022 94 3	207		5165019	2027 15 1	253		
5441175	2007 43 2	169	5157458	2012 92 8	221		5004141	2022 94 5	207		5165071	2027 21 6	253		
5441182	2007 43 4	169					5004158	2022 94 7	207		5165132	2027 29 1	253		
5441212	2007 43 6	170	5515173	2013 00 2	220	1627180	5004202	2022 94 9	207						
5682189	2007 44 0	170	5515234	2013 00 6	220	1627181	5004240	2022 95 1	207		5035299	2028 87 0	213		
5682196	2007 44 4	170	5515296	2013 00 7	220	1627182	5004257	2022 95 3	207		5035299	2028 87 0	232		
5682202	2007 44 8	171	5515357	2013 00 8	220	1627186	5004264	2022 95 5	207		5035299	2028 87 0	212		
5286615	2007 50 9	169	5515418	2013 00 9	220	1627189	5004301	2022 95 7	207		5035299	2028 87 0	254		
5286622	2007 51 7	169	5515470	2013 01 0	220	1627189	5004363	2022 96 4	207		5035350	2028 87 3	212		
5286660	2007 52 5	169	5515531	2013 01 1	220	1627159	5004370	2022 96 6	207		5035350	2028 87 3	213		
5286677	2007 53 3	170	5515593	2013 01 2	220	1627160	5004387	2022 96 8	207		5035350	2028 87 3	232		
5286684	2007 54 1	170	5515654	2013 01 3	220	1627161	5004424	2022 97 0	207		5035350	2028 87 3	254		
5286721	2007 55 4	170	5515715	2013 01 5	220	1627162	5004486	2022 97 2	207		5035411	2028 87 5	254		
5286738	2007 56 8	171	5515777	2013 01 6	220	1627154	5004493	2022 97 4	207		5035411	2028 87 5	213		
5303237	2007 62 2	169	5515838	2013 01 7	220	1627156	5004509	2022 97 6	207		5035411	2028 87 5	212		
5303244	2007 63 0	169	5515890	2013 01 8	220	1627158	5004547	2022 97 8	207		5035473	2028 87 7	213		
5303275	2007 63 8	169	5515951	2013 01 9	220						5035473	2028 87 7	212		
5303282	2007 64 4	170	5516019	2013 02 0	220		5161653	2023 09 1	225		5035473	2028 87 7	254		
5303299	2007 64 9	170	5516071	2013 02 1	220		5161714	2023 11 3	225		5035534	2028 88 0	212		
5303305	2007 65 7	170	5516132	2013 02 2	220		5161776	2023 12 1	225		5035534	2028 88 0	254		
5303312	2007 66 5	171	5516194	2013 02 5	220		5161837	2023 16 4	225		5035534	2028 88 0	213		
			5516255	2013 02 6	220		5161899	2023 21 0	225		5035534	2028 88 0	232		
5615767	2007 80 1	176	5516316	2013 02 7	220		5161950	2023 29 6	225		5035596	2028 88 3	212		
5615774	2007 80 3	176	5516378	2013 02 8	220		5162018	2023 50 4	219		5035596	2028 88 3	254		
5615781	2007 80 5	176	5516439	2013 02 9	220		5162070	2023 51 2	219		5035596	2028 88 3	213		
5615811	2007 80 7	176	5516491	2013 03 0	220		5162131	2023 52 0	219		5035596	2028 88 3	232		
5615828	2007 80 9	176	5516552	2013 03 1	220		5162193	2023 53 9	219		5035718	2028 88 5	213		
5615835	2007 81 1	177	5516613	2013 03 2	220		5162254	2023 54 7	219		5035718	2028 88 5	232		

Numeroluettelo

EAN-C.	Tuotenumero	Sida	snro-nr.	EAN-C.	Tuotenumero	Sida	snro-nr.	EAN-C.	Tuotenumero	Sida	snro-nr.	EAN-C.	Tuotenumero	Sida	snro-nr.
5843672	2028 91 3	213		5036371	2029 69 6	212		5402978	2030 65 5	226	1729123	5170297	2033 09 7	224	1711423
5843672	2028 91 3	232		5167594	2029 70 7	232		5403517	2030 65 9	226	1729127	5170358	2033 11 9	224	1711424
5843672	2028 91 3	233		5167594	2029 70 7	255		5403999	2030 66 1	226	1729133	5170419	2033 13 5	224	1711425
5843733	2028 92 1	254		5167594	2029 70 7	233		5404118	2030 66 4	226	1729140	5170471	2033 15 1	224	1711426
5843733	2028 92 1	213		5167655	2029 71 5	233		5405610	2030 66 7	226	1729128	5170532	2033 21 6	224	1711427
5843733	2028 92 1	232		5167655	2029 71 5	255		5405795	2030 67 0	226	1729134	5170594	2033 29 1	224	1711428
5843733	2028 92 1	233		5167655	2029 71 5	232		5405856	2030 67 3	226	1729141	5170655	2033 36 4	224	1711429
5843795	2028 94 8	254		5167716	2029 72 3	233		5407713	2030 67 5	226	1729150	5170716	2033 42 9	224	1711430
5843795	2028 94 8	213		5167716	2029 72 3	232		5824350	2030 70 5	227	1711442	5170778	2033 48 8	224	1711431
5843795	2028 94 8	232		5167716	2029 72 3	255		5434238	2030 71 3	227	1711443				
5843795	2028 94 8	233		5167778	2029 73 1	233		5434351	2030 74 8	227	1711444	5464952	2035 31 6	215	1729012
5843856	2028 95 6	233		5167778	2029 73 1	255		5434412	2030 75 6	227	1711445	5465072	2035 32 4	215	1729016
5843856	2028 95 6	213		5167778	2029 73 1	232		5907510	2030 76 4	227	1711446	5465256	2035 33 2	215	1729020
5843856	2028 95 6	232		5167839	2029 75 8	233		5434535	2030 77 2	227	1711447	5465317	2035 34 0	215	1729025
5843856	2028 95 6	254		5167839	2029 75 8	255		5434597	2030 78 0	227	1711448	5467410	2035 35 9	215	1729032
5843917	2028 96 4	254		5167839	2029 75 8	232		5824411	2030 79 9	227	1711449	5467472	2035 36 7	215	1729040
5843917	2028 96 4	233		5167891	2029 76 6	232		5434658	2030 80 2	227	1711450	5467953	2035 37 5	215	1729050
5843917	2028 96 4	213		5167891	2029 76 6	255		5434719	2030 81 0	227	1711452	5468011	2035 38 3	215	1729063
5843917	2028 96 4	232		5167891	2029 76 6	233		5824534	2030 82 9	227	1711451	5468134	2035 41 3	214	
5843979	2028 97 2	254		5167952	2029 77 4	232		5824534	2030 83 7	227	1711453	5468370	2035 42 1	214	
5843979	2028 97 2	213		5167952	2029 77 4	233		5433873	2030 89 6	228	1711462	5468431	2035 44 8	214	
5843979	2028 97 2	232		5167952	2029 77 4	255		5433934	2030 93 4	228	1711463	5468493	2035 45 6	214	
5843979	2028 97 2	233		5445395	2029 90 1	229		5433996	2030 95 0	228	1711464	5468554	2035 46 4	214	
5844037	2028 98 0	233		5445456	2029 92 8	229		5434054	2030 97 7	228	1711465	5468615	2035 47 2	214	
5844037	2028 98 0	213		5445517	2029 93 6	229		5825012	2030 98 5	228	1711467	5468677	2035 48 0	214	
5844037	2028 98 0	232		5445579	2029 94 4	229		5434115	2030 99 3	228	1711466	5468738	2035 49 9	214	
5844037	2028 98 0	254		5445630	2029 95 2	229						5520276	2035 51 0	217	
5844099	2028 99 9	254						5445753	2031 30 2	227		5520337	2035 51 2	217	
5844099	2028 99 9	233		5374299	2030 00 4	253	FI 1729212	5445814	2031 32 9	227	1711441	5520399	2035 51 4	217	
5844099	2028 99 9	213		5374299	2030 00 4	231	FI 1729212	5445937	2031 34 5	227	1711454	5520450	2035 51 6	217	
5844099	2028 99 9	232		5374350	2030 00 8	231	FI 1729216	5446057	2031 38 8	227	1711455	5520511	2035 51 8	217	
				5374350	2030 00 8	253	FI 1729216	5446118	2031 41 8	227		5520573	2035 52 0	217	
5167051	2029 10 3	231		5375678	2030 01 2	231	FI 1729220	5446170	2031 44 2	227		5520634	2035 52 2	217	
5167051	2029 10 3	230		5375678	2030 01 2	253	FI 1729220	5371878	2031 45 0	227	1729680				
5167051	2029 10 3	252		5375913	2030 01 6	231	FI 1729225	5371885	2031 45 1	227	1729681	5172093	2036 06 1	215	
5167112	2029 11 1	231		5375913	2030 01 6	253	FI 1729225	5371915	2031 45 2	227	1729682	5172154	2036 08 8	217	
5167112	2029 11 1	230		5376156	2030 02 0	231	FI 1729232	5371922	2031 45 3	227	1729683	5172215	2036 09 6	215	
5167112	2029 11 1	252		5376156	2030 02 0	253	FI 1729232	5371939	2031 45 4	227	1729684	5172277	2036 11 8	215	
5167174	2029 13 8	231		5376514	2030 02 4	253	FI 1729240	5371946	2031 45 6	228	1729633	5172338	2036 12 6	217	
5167174	2029 13 8	230		5376514	2030 02 4	231	FI 1729240	5371977	2031 45 7	228	1729634	5172390	2036 13 4	215	
5167174	2029 13 8	252		5376576	2030 02 8	231	FI 1729250	5371984	2031 45 8	228	1729637	5172451	2036 14 2	217	
5167235	2029 16 2	231		5376576	2030 02 8	253	FI 1729250	5371991	2031 45 9	228	1729638	5172512	2036 15 0	217	
5167235	2029 16 2	230		5377290	2030 03 2	253	FI 1729263	5372004	2031 46 0	228	1729641	5172574	2036 16 9	215	
5167235	2029 16 2	252		5377290	2030 03 2	231	FI 1729263	5372011	2031 46 1	228	1729645	5172635	2036 21 5	215	
5167297	2029 21 9	231		5168195	2030 07 1	231		5372028	2031 46 2	228	1729647	5172697	2036 22 3	217	
5167297	2029 21 9	230		5168195	2030 07 1	253		5372035	2031 46 3	228	1729649	5172758	2036 29 0	215	
5167297	2029 21 9	252		5168195	2030 07 1	232		5372042	2031 46 5	228	1729602	5172819	2036 30 4	217	
5167358	2029 29 4	230		5168256	2030 09 8	231		5372059	2031 46 6	228	1729604	5172871	2036 36 3	215	
5167358	2029 29 4	252		5168256	2030 09 8	253		5372066	2031 46 7	228	1729607	5172932	2036 37 1	217	
5167358	2029 29 4	231		5168256	2030 09 8	232		5372073	2031 46 8	228	1729611	5172994	2036 42 8	215	
5167419	2029 36 7	230		5168317	2030 10 1	232		5372080	2031 46 9	228	1729613	5173052	2036 43 6	217	
5167419	2029 36 7	252		5168317	2030 10 1	231		5372097	2031 47 0	228	1729616	5173113	2036 48 7	215	
5167419	2029 36 7	231		5168317	2030 10 1	253		5372103	2031 47 1	228	1729619	5173175	2036 49 5	217	
5167471	2029 42 1	230		5168379	2030 13 6	253						5173298	2036 51 7	214	
5167471	2029 42 1	252		5168379	2030 13 6	231		5477556	2032 00 7	229		5173359	2036 53 3	214	
5167471	2029 42 1	231		5168379	2030 13 6	232		5477617	2032 01 1	229		5173410	2036 57 6	214	
5167532	2029 48 0	231		5168430	2030 16 0	231		5477730	2032 01 5	229		5173472	2036 59 2	214	
5167532	2029 48 0	252		5168430	2030 16 0	253		5477792	2032 01 9	229		5173533	2036 61 4	214	
5167532	2029 48 0	230		5168430	2030 16 0	232		5477853	2032 02 3	229		5173595	2036 63 0	214	
5389934	2029 51 1	213		5168492	2030 21 7	253		5477914	2032 03 1	229		5173656	2036 65 7	214	
5389941	2029 51 4	213		5168492	2030 21 7	231		5168973	2032 09 0	230					
5389972	2029 51 7	213		5168492	2030 21 7	232		5169031	2032 11 2	230		5175216	2038 04 8	216	
5389989	2029 52 0	213		5168553	2030 29 2	232		5169093	2032 13 9	230		5469636	2038 07 2	216	
5389996	2029 52 3	213		5168553	2030 29 2	231		5169154	2032 16 3	230					
5360582	2029 56 0	212		5168553	2030 29 2	253		5169215	2032 20 1	230		5175759	2039 02 8	216	
5360599	2029 56 3	212		5168614	2030 36 5	232		5481454	2032 37 8	229		5175810	2039 04 4	216	
5360605	2029 56 6	212		5168614	2030 36 5	231		5481515	2032 38 0	229		5175872	2039 06 0	216	
5360636	2029 56 9	212		5168614	2030 36 5	253		5481577	2032 38 2	229		5175933	2039 08 7	216	
5360643	2029 57 2	212		5168676	2030 41 1	232		5481638	2032 38 4	229		5175995	2039 10 9	216	
5360650	2029 57 5	212		5168676	2030 41 1	231		5481690	2032 38 6	229		5176053	2039 12 5	216	
5360667	2029 57 8	212		5168676	2030 41 1	253		5481812	2032 38 8	229					
5360698	2029 58 1	212		5168737	2030 48 9	232		5169819	2032 50 3	230		5176893	2040 04 2	218	
5824596	2029 61 8	212		5168737	2030 48 9	231		5169871	2032 51 1	230		5176954	2040 06 9	218	
5824657	2029 62 6	212		5168737	2030 48 9	253		5169932	2032 53 8	230		5177012	2040 08 5	218	
5824718	2029 63 4	212		5377412	2030 61 6										

Numeroluettelo

EAN-numeron rakenne: maatumnus 40

valmistajan tunnus 1219 (tuotenumeroille, jotka alkavat numerolla 0 pätee: 1010)

yksilöllinen EAN-C 5647589

EAN-C.	Tuotenro	Sida	snro-nr.	EAN-C.	Tuotenro	Sida	snro-nr.	EAN-C.	Tuotenro	Sida	snro-nr.	EAN-C.	Tuotenro	Sida	snro-nr.
5180074	2044 09 9	310		5622741	2047 39 1	309		5621928	2047 54 2	308		5446477	2048 75 2	222	
5180135	2044 11 0	310		5622758	2047 39 2	309		5621935	2047 54 4	307		5446538	2048 76 0	222	
5180197	2044 13 7	310		5622765	2047 39 3	309		5621942	2047 54 5	307		5446590	2048 77 9	222	
5180258	2044 16 1	310		5153283	2047 39 5	307		5621959	2047 54 6	307		5446651	2048 78 7	222	
5180319	2044 21 8	310		5153290	2047 39 6	307		5621966	2047 54 7	307		5446712	2048 79 5	222	
5180371	2044 29 3	310		5153306	2047 39 7	307		5621973	2047 54 8	307		5088752	2048 80 9	222	
5180432	2044 36 6	310		5153344	2047 39 8	307		5621980	2047 54 9	307		5088875	2048 81 7	222	
5180494	2044 42 0	310		5153351	2047 39 9	307		5621997	2047 55 0	307		5088936	2048 82 5	222	
5180555	2044 47 1	310		5153368	2047 40 0	307		5622000	2047 55 2	306		5874157	2048 90 6	222	1729013
5180852	2044 66 8	310		5153405	2047 40 1	307		5622017	2047 55 3	306		5874218	2048 91 4	222	1729017
5180913	2044 71 4	310		5622772	2047 40 4	309		5622024	2047 55 4	306		5944539	2048 92 2	222	1729021
5180975	2044 78 1	310		5622789	2047 40 5	309		5622031	2047 55 5	306		5944591	2048 93 0	222	1729026
5181033	2044 86 2	310		5622796	2047 40 6	309		5622048	2047 55 6	306		5944652	2048 94 9	222	1729033
				5622802	2047 40 7	309		5622055	2047 55 7	306		5088998	2048 95 7	222	1729041
5181279	2045 09 5	245	FI 1711473	5622840	2047 40 8	309		5622062	2047 55 8	306		5089056	2048 96 5	222	1729051
5181279	2045 09 5	244	FI 1711473	5622857	2047 40 9	309		5622079	2047 56 0	306		5089117	2048 97 3	222	1729064
5181330	2045 11 7	245	FI 1711474	5153412	2047 41 0	306		5622086	2047 56 1	306					
5181330	2045 11 7	244	FI 1711474	5153429	2047 41 1	306		5622123	2047 56 2	306		5089179	2049 06 6	222	
5181392	2045 13 3	244	FI 1711475	5153467	2047 41 2	306		5622130	2047 56 3	306		5095354	2049 07 4	222	
5181392	2045 13 3	245	FI 1711475	5153474	2047 41 3	306		5622147	2047 56 4	306		5095415	2049 08 2	222	
5181453	2045 16 8	245	FI 1711476	5153481	2047 41 4	306		5622154	2047 56 5	306		5095538	2049 09 0	222	
5181453	2045 16 8	244	FI 1711476	5153528	2047 41 5	306		5622161	2047 56 6	306		5095651	2049 10 4	222	
5181514	2045 21 4	244	FI 1711477	5153535	2047 41 6	306		5622178	2047 56 8	309		5095712	2049 11 2	222	
5181514	2045 21 4	245	FI 1711477	5153658	2047 42 5	307		5622185	2047 56 9	309		5096313	2049 12 0	222	
5181576	2045 28 1	245	FI 1711478	5153665	2047 42 6	307		5622192	2047 57 0	309		5127758	2049 13 9	222	
5181576	2045 28 1	244	FI 1711478	5153702	2047 42 7	307		5622208	2047 57 1	309		5128656	2049 50 3	223	
5181637	2045 36 2	244	FI 1711479	5153719	2047 42 8	307		5622215	2047 57 2	309		5139331	2049 51 1	223	
5181637	2045 36 2	245	FI 1711479	5153726	2047 42 9	307		5622222	2047 57 3	309		5153313	2049 53 8	223	
				5153764	2047 43 0	307		5622239	2047 57 4	309		5155478	2049 54 6	223	
5181811	2046 07 5	245		5153771	2047 43 1	307						5161592	2049 55 4	223	
5181873	2046 09 1	245		5153788	2047 44 0	305		5622246	2047 65 0	305		5228615	2049 56 2	223	
5181934	2046 11 3	245		5153825	2047 44 1	305		5622253	2047 65 1	305		5232810	2049 57 0	223	
5181996	2046 12 1	245		5153832	2047 44 2	305		5622260	2047 65 2	305		5315018	2049 58 9	223	
5182054	2046 16 4	245		5153849	2047 44 3	305		5622291	2047 65 3	305					
5182115	2046 21 0	245		5153887	2047 44 4	305		5622307	2047 65 4	305		5622819	2050 00 5	210	
5182177	2046 29 6	245		5153894	2047 44 5	305		5622338	2047 65 7	304		5907633	2050 01 3	210	
5182238	2046 36 9	245		5153900	2047 44 6	305		5622345	2047 65 8	304		5907572	2050 02 1	210	
5182290	2046 42 3	245		5380986	2047 45 5	308		5622352	2047 66 0	304		5830290	2050 04 8	210	
5182351	2046 48 2	245		5380993	2047 45 6	308		5622369	2047 66 1	304		5622093	2050 05 6	210	
				5381006	2047 45 7	308		5622376	2047 66 2	304		5620952	2050 06 4	210	
				5381037	2047 45 8	308						5618973	2050 07 2	210	
				5381044	2047 45 9	308		5622406	2047 66 5	309		5615071	2050 08 0	210	
5246275	2047 30 5	305		5381051	2047 46 0	308		5622413	2047 66 6	309		5612490	2050 09 9	210	
5069270	2047 30 6	304		5381068	2047 46 1	308		5622420	2047 66 8	309		5606017	2050 10 2	210	
5246282	2047 30 8	305		5381099	2047 47 0	307		5622437	2047 66 9	309		5829997	2050 14 5	210	
5069287	2047 30 9	304		5381105	2047 47 1	307		5622444	2047 67 0	309		5601210	2050 15 3	210	
5246299	2047 31 1	305		5381112	2047 47 2	307		5622475	2047 67 3	308		5600855	2050 16 1	210	
5069294	2047 31 2	304		5381129	2047 47 3	307		5622482	2047 67 4	308		5212232	2050 18 8	210	
5246305	2047 31 4	305		5381150	2047 47 4	307		5622499	2047 67 6	308		5208631	2050 19 6	210	
5069300	2047 31 5	304		5381167	2047 47 5	307		5622505	2047 67 7	308		5596295	2050 30 7	211	
5246312	2047 31 7	305		5381174	2047 47 6	307		5622512	2047 67 8	308		5594857	2050 31 5	211	
5069331	2047 31 8	304		5381181	2047 48 5	306		5622543	2047 68 2	307		5594734	2050 32 3	211	
5246329	2047 32 0	305		5381198	2047 48 6	306		5622550	2047 68 3	307		5594673	2050 33 1	211	
5069348	2047 32 1	304		5381204	2047 48 7	306		5622567	2047 68 4	307		5594611	2050 35 8	211	
5246336	2047 32 3	305		5381211	2047 48 8	306		5622574	2047 68 5	307		5315131	2050 36 6	211	
5069355	2047 32 4	304		5381228	2047 48 9	306		5622581	2047 68 6	307		5316695	2050 37 4	211	
5246350	2047 33 5	304		5381235	2047 49 0	306		5622611	2047 69 0	306		5373391	2050 38 2	211	
5152880	2047 33 6	304		5381242	2047 49 1	306		5622628	2047 69 2	306					
5246367	2047 33 8	304		5381259	2047 50 1	305		5622635	2047 69 3	306		5183198	2054 00 0	200	1932566
5152910	2047 33 9	304		5381266	2047 50 2	305		5622642	2047 69 4	306		5183259	2054 01 9	200	1932567
5246374	2047 34 1	304		5381273	2047 50 3	305		5622659	2047 69 5	306		5183310	2054 08 6	200	1932568
5152927	2047 34 2	304		5381280	2047 50 4	305						5183372	2054 09 4	200	1932569
5246381	2047 34 4	304		5381297	2047 50 5	305		5490753	2047 81 0	310		5879916	2054 48 5	203	1339817
5152934	2047 34 5	304		5381303	2047 50 6	305		5490692	2047 82 9	310		5825319	2054 50 7	203	1339819
5246398	2047 34 7	304		5381334	2047 50 7	305		5490630	2047 83 7	310		5477976	2054 52 3	203	1339821
5152941	2047 34 8	304						5487692	2047 85 3	310					
5246404	2047 35 0	304		5621720	2047 52 0	305		5037699	2047 86 1	310		5183433	2055 02 3	200	
5152972	2047 35 1	304		5621737	2047 52 1	305		5037637	2047 88 8	310		5183853	2055 20 1	200	
5246411	2047 35 3	304		5621744	2047 52 2	305		5037576	2047 89 6	310		5183914	2055 50 3	200	
5152989	2047 35 4	304		5621751	2047 52 3	305		5468851	2047 93 4	310		5432258	2055 92 9	201	
				5621768	2047 52 4	305		5468912	2047 94 2	310					
5152996	2047 36 5	308		5621775	2047 52 5	305		5468974	2047 95 0	310		5702610	2056 07 0	201	
5153009	2047 36 6	308		5621782	2047 52 6	305		5469155	2047 96 9	310		5879251	2056 08 9	201	
5153047	2047 36 7	308		5621799	2047 52 8	304		5469216	2047 97 7	310		5184331	2056 14 3	201	
5153054	2047 36 8	308		5621805	2047 52 9	304		5469278	2047 98 5	310		5184393	2056 17 8	201	
5153061	2047 36 9	308		5621812	2047 53 0	304		5469339	2047 99 3	310		5702559	2056 22 4	202	
5153108	2047 37 0	308		5621829	2047 53 1	304						5879312	2056 23 2	202	
5153115															

EAN-C.	Tuotonro	Sida	snro-nr.	EAN-C.	Tuotonro	Sida	snro-nr.	EAN-C.	Tuotonro	Sida	snro-nr.	EAN-C.	Tuotonro	Sida	snro-nr.
5479055	2079 84 4	239	FI 1711225	5188896	2084 13 9	247		5372301	2088 29 8	252	1729758	5193272	2089 23 8	250	1729497
5479178	2079 85 2	239	FI 1711232	5188957	2084 16 3	247		5372318	2088 29 9	252	1729759	5193333	2089 25 4	250	1729498
5479239	2079 86 0	239	FI 1711240	5189015	2084 20 1	247		5372325	2088 30 1	251	1729763	5193395	2089 27 0	250	1729499
5479291	2079 87 9	239	FI 1711250	5189077	2084 29 5	247		5372332	2088 30 2	251	1729766	5193456	2089 29 7	250	1729500
5479352	2079 88 7	239	FI 1711263	5189138	2084 36 8	247		5372349	2088 30 3	251	1729768	5193517	2089 31 9	250	1729501
5204558	2079 90 5	241	1711616	5189190	2084 42 2	247		5372356	2088 30 4	251	1729771	5193579	2089 33 5	250	1729502
5514930	2079 90 9	241	1711620	5189251	2084 48 1	247		5372363	2088 30 5	251	1729774	5193630	2089 35 1	250	1729503
5514992	2079 91 3	241	1711625					5372400	2088 30 6	251	1729777	5193692	2089 38 6	250	1729504
5203834	2079 91 7	241	1711632	5189916	2085 60 7	237	1729401	5372417	2088 30 7	251	1729779	5193753	2089 40 8	250	1729505
5517399	2079 92 1	241	1711640	5189978	2085 61 5	237	1729402	5390923	2088 31 0	251		5193814	2089 42 4	250	1729506
5517511	2079 92 5	241	1711650	5190035	2085 62 3	237	1729403	5390930	2088 31 2	251		5193876	2089 44 0	250	1729507
5517634	2079 92 9	241	1711663	5190097	2085 63 1	237	1729404	5390947	2088 31 4	251		5475392	2089 50 5	249	1729508
				5190158	2085 65 8	237	1729405	5390954	2088 31 6	251		5475453	2089 51 3	249	1729509
5185055	2080 07 9	239	1729422	5448631	2085 66 6	237	1729406	5390961	2088 31 8	251		5475514	2089 52 1	249	1729510
5185116	2080 09 5	239	1729423	5448693	2085 67 4	237	1729407	5391005	2088 32 0	251		5475576	2089 54 8	249	1729511
5185178	2080 11 7	239	FI 1729424	5448754	2085 68 2	237	1729408	5391012	2088 32 2	251		5475637	2089 55 6	249	1729512
5185239	2080 13 3	239	FI 1729425	5448815	2085 69 0	237	1729409	5391029	2088 32 4	251		5475699	2089 56 4	249	1729513
5185291	2080 16 8	239	FI 1729426	5448877	2085 70 4	237	1729410	5391067	2088 32 8	251		5475750	2089 57 2	249	1729514
5185352	2080 21 4	239	FI 1729427	5840732	2085 72 0	237		5391074	2088 33 0	251		5475811	2089 58 0	249	1729515
5185413	2080 28 1	239	FI 1729428	5840794	2085 73 9	237		5391081	2088 33 4	251		5475873	2089 59 9	249	1729516
5185475	2080 36 2	239	FI 1729429	5840855	2085 74 7	237		5391128	2088 33 6	251		5476412	2089 60 2	249	1729517
5185536	2080 42 7	239	1729430	5840916	2085 75 5	237		5391135	2088 34 0	251		5476474	2089 61 0	249	1729518
5185598	2080 48 6	239	1729431	5840978	2085 76 3	237		5391142	2088 34 4	251		5476535	2089 62 9	249	1729519
5185659	2080 50 8	241	1711511	5841036	2085 77 1	237		5391173	2088 34 6	251		5476597	2089 63 7	249	1729520
5185710	2080 52 4	241	1711513	5841098	2085 79 8	237		5391180	2088 34 8	251					
5185772	2080 54 0	241	1711516	5841210	2085 83 6	237		5469810	2088 42 8	231	FI 1729217	5193937	2090 07 4	247	1729458
5185833	2080 56 7	241	1711521					5469810	2088 42 8	253	FI 1729217	5193999	2090 09 0	247	1729459
5185895	2080 58 3	241	1711529	5808992	2086 01 8	236		5469933	2088 43 6	231	FI 1729221	5194057	2090 11 2	247	1729460
5185956	2080 60 5	241	1711536	5809234	2086 02 4	236		5469933	2088 43 6	253	FI 1729221	5194118	2090 13 9	247	1729461
5186014	2080 70 2	240		5809418	2086 03 0	236		5469995	2088 44 4	253	FI 1729226	5194170	2090 16 3	247	1729462
5186076	2080 72 9	240		5809593	2086 03 6	236		5469995	2088 44 4	231	FI 1729226	5194231	2090 20 1	247	1729463
5186137	2080 74 5	240		5809777	2086 04 2	236		5470052	2088 45 2	231	FI 1729233	5194293	2090 29 5	247	1729464
5186199	2080 76 1	240		5809890	2086 04 8	236		5470052	2088 45 2	253	FI 1729233	5194354	2090 36 8	247	1729465
5186250	2080 79 6	240		5810070	2086 05 4	236		5470533	2088 46 0	231	FI 1729241	5194415	2090 42 2	247	1729466
				5810131	2086 06 0	236		5470533	2088 46 0	253	FI 1729241	5194477	2090 48 1	247	1729467
5186373	2081 07 5	240		5810254	2086 11 1	236		5470595	2088 47 9	231	FI 1729251	5471738	2090 51 1	247	1729468
5186434	2081 09 1	240		5810377	2086 11 7	236		5470595	2088 47 9	253	FI 1729251	5471790	2090 53 8	247	1729469
5186496	2081 11 3	240		5810438	2086 12 3	236		5470953	2088 70 3	231	1729214	5472810	2090 54 6	247	1729470
5186557	2081 14 8	240		5810735	2086 12 9	236		5470953	2088 70 3	254	1729214	5472933	2090 55 4	247	1729471
5186618	2081 16 4	240		5810858	2086 13 5	236		5470953	2088 70 3	232	1729214	5472995	2090 56 2	247	1729472
5186670	2081 21 0	240		5810971	2086 14 1	236		5471011	2088 71 1	231	1729218	5473411	2090 57 0	247	1729473
				5811152	2086 14 7	236		5471011	2088 71 1	254	1729218	5474012	2090 58 9	247	1729474
5186977	2082 07 1	243		5811213	2086 15 3	236		5471011	2088 71 1	232	1729218	5474074	2090 59 7	247	1729475
5187035	2082 09 8	243		5655435	2086 16 5	238	1729650	5471257	2088 73 8	232	1729222				
5187097	2082 10 1	243		5655480	2086 16 9	238	1729651	5471257	2088 73 8	231	1729222	5194538	2091 07 0	246	1729440
5187158	2082 13 6	243		5655497	2086 17 3	238	1729652	5471257	2088 73 8	254	1729222	5194590	2091 09 7	246	1729441
5187219	2082 16 0	243		5655503	2086 17 7	238	1729653	5471318	2088 74 6	231	1729227	5194651	2091 11 9	246	1729442
5187271	2082 21 7	243		5655534	2086 18 1	238	1729654	5471318	2088 74 6	232	1729227	5194712	2091 13 5	246	1729443
5187332	2082 29 2	243		5655541	2086 18 5	238	1729655	5471318	2088 74 6	254	1729227	5194774	2091 15 1	246	1729444
5187394	2082 36 5	243		5655558	2086 18 9	238	1729656	5471370	2088 75 4	231	1729234	5194835	2091 21 6	246	1729445
5187455	2082 41 1	243		5655565	2086 20 3	238		5471370	2088 75 4	254	1729234	5194897	2091 29 1	246	1729446
5187516	2082 48 9	243		5655572	2086 20 7	238		5471370	2088 75 4	232	1729234	5194958	2091 36 4	246	1729447
5187578	2082 50 0	242		5655589	2086 21 1	238		5471554	2088 76 2	231	1729242	5195016	2091 42 9	246	1729448
5582670	2082 51 9	242		5655596	2086 21 5	238		5471554	2088 76 2	232	1729242	5195078	2091 48 8	246	1729449
5187639	2082 52 7	242		5655602	2086 21 9	238		5471554	2088 76 2	254	1729242	5474135	2091 60 7	246	1711312
5187691	2082 54 3	242		5655619	2086 22 3	238		5471615	2088 77 0	232	1729252	5931690	2091 61 5	246	1711316
5187752	2082 57 8	242		5655626	2086 22 7	238		5471615	2088 77 0	231	1729252	5931751	2091 62 3	246	1711320
5187813	2082 59 4	242		5655657	2086 23 1	238		5471615	2088 77 0	254	1729252	5931812	2091 63 1	246	1711325
5187875	2082 61 6	242						5471677	2088 78 9	232	1729265	5931874	2091 65 8	246	1711332
5187936	2082 70 5	244		5190813	2088 02 9	249	1729476	5471677	2088 78 9	231	1729265	5474197	2091 66 6	246	1711340
5187998	2082 71 3	244		5190875	2088 04 5	249	1729477	5471677	2088 78 9	254	1729265	5474791	2091 67 4	246	1711350
5188056	2082 72 1	244		5190936	2088 06 1	249	1729478	5192190	2088 81 9	232		5474852	2091 68 2	246	1711363
5188117	2082 74 8	244		5190998	2088 09 6	249	1729479	5192190	2088 81 9	254					
				5191056	2088 12 6	249	1729480	5192251	2088 82 7	232		5195252	2101 01 7	266	
5188292	2083 09 4	244		5191117	2088 14 2	249	1729481	5192251	2088 82 7	254		5195313	2101 03 3	266	
5188353	2083 11 6	244		5191179	2088 16 9	249	1729482	5192312	2088 83 5	232		5195375	2101 06 8	266	
5188414	2083 13 2	244		5191230	2088 18 5	249	1729483	5192312	2088 83 5	254					
5188476	2083 16 7	244		5191292	2088 20 7	249	1729484	5192374	2088 84 3	254		5195436	2105 01 2	267	
5188537	2083 21 3	244		5191353	2088 22 3	249	1729485	5192374	2088 84 3	232		5195498	2105 03 9	267	
5188599	2083 29 9	244		5191414	2088 25 8	249	1729486	5192435	2088 85 1	232		5195559	2105 05 5	267	
5481331	2083 61 2	243		5191476	2088 27 4	249									

Numeroluettelo

EAN-numeron rakenne: maatuennus **40**valmistajan tunnus **1219** (tuotenumeroille, jotka alkavat numerolla **0** pätee: **1010**)yksilöllinen EAN-C **5647589**

EAN-C.	Tuoteno	Sida	snro-nr.	EAN-C.	Tuoteno	Sida	snro-nr.	EAN-C.	Tuoteno	Sida	snro-nr.	EAN-C.	Tuoteno	Sida	snro-nr.
5197119	2130 15 7	268		5742395	2153 71 8	259		5651666	2205 41 6	263	1317442	5218296	2227 74 6	272	
5197171	2130 18 1	268		5741732	2153 72 6	259						5607694	2227 76 2	272	
5197232	2130 21 1	268		5741671	2153 73 4	259		5651703	2205 42 0	263		5607878	2227 79 7	272	
5197294	2130 25 4	268		5505334	2153 78 5	259						5218357	2227 80 0	272	
5197355	2130 28 9	268		5505396	2153 78 7	259		5651710	2205 42 3	263		5218418	2227 81 9	272	
5197416	2130 35 1	268		5505457	2153 78 9	259						5218470	2227 82 7	272	
5197478	2130 40 8	268										5218593	2227 91 6	272	
5197539	2130 43 2	268		5509950	2153 82 9	311	1156028	5863953	2207 02 8	277	1317423	5218654	2227 92 4	272	
5197591	2130 47 5	268		5469391	2153 83 1	311	1156030	5798798	2207 03 6	277	1317426				
5197652	2130 54 8	268		5510017	2153 83 3	311	1156032	5022497	2207 06 0	277	1317417	5218777	2228 02 5	272	
				5510079	2153 83 5	311	1156034					5218838	2228 03 3	272	
5198970	2140 06 3	269	1339440	5510130	2153 86 4	311	1156044	5213017	2213 11 7	271		5218951	2228 11 4	272	
5199038	2140 07 1	269	1339441	5469452	2153 86 6	311	1156046					5219019	2228 12 2	272	
5199090	2140 10 1	269	1339442	5510192	2153 86 8	311	1156047	5599777	2214 87 3	271		5219132	2228 21 1	272	
5199151	2140 12 8	269	1339443	5510253	2153 87 0	311	1156048	5599838	2214 88 1	271		5219194	2228 23 8	272	
5199212	2140 15 2	269	1339444	5510314	2153 87 2	312	1156058					5219255	2228 30 0	272	
5199274	2140 18 7	269	1339445	5469575	2153 87 4	312	1156060	5213130	2215 04 7	271		5219316	2228 31 9	272	
5199335	2140 23 3	269	1339446	5510376	2153 87 6	312	1156062	5213192	2215 07 1	271		5219378	2228 40 8	272	
5199397	2140 28 4	269	1339447	5510437	2153 87 8	312	1156064	5213253	2215 10 1	271		5219439	2228 41 6	272	
5199458	2140 35 7	269	1339448					5213314	2215 14 4	271		5496397	2228 42 0	272	
5199519	2140 41 1	269	1339449	5028093	2153 90 4	311	1156011	5213376	2215 17 9	271		5496458	2228 42 2	272	
5199694	2140 60 8	270	1339452	5027799	2153 91 2	311	1156013	5213437	2215 20 9	271		5608110	2228 43 2	272	
5199878	2140 65 9	270	1339455	5025214	2153 92 0	311	1156015	5213550	2215 30 6	271		5608172	2228 44 0	272	
5199939	2140 68 3	270	1339456	5025153	2153 93 9	311	1156019	5213611	2215 31 4	271		5219552	2228 61 0	272	FI 1319507
5199991	2140 72 1	270	1339457	5538578	2153 96 0	311	1156010	5213673	2215 32 2	271		5219613	2228 62 9	272	FI 1319508
				5538639	2153 96 3	311	1156012	5213734	2215 33 0	271		5496519	2228 68 6	272	
5595359	2146 05 3	260	LVI322501	5531739	2153 96 6	311	1156014	5213796	2215 34 9	271		5828556	2228 68 8	272	
5595410	2146 06 1	260	LVI322501	5538691	2153 96 9	311	1156018	5213857	2215 35 7	271		5219675	2228 71 8	272	FI 1319512
5595472	2146 09 6	260	LVI322501									5219736	2228 72 6	272	
5595533	2146 11 8	260	LVI322501	5538752	2153 97 1	311	1156020	5214038	2222 03 5	270		5219798	2228 73 4	272	FI 1319513
5595656	2146 13 4	260	LVI322501	5538813	2153 97 3	311	1156022	5214090	2222 05 1	270		5608837	2228 75 0	272	
5595717	2146 20 7	260	LVI322502	5538875	2153 97 5	311	1156024	5214151	2222 07 8	270		5219859	2228 82 3	272	
5595779	2146 21 5	260	LVI322502	5538936	2153 97 7	311	1156026	5214212	2222 08 6	270		5219910	2228 83 1	272	FI 1319514
5595830	2146 25 8	260	LVI322502	5538998	2153 98 0	311	1156036	5214274	2222 09 4	270		5219972	2228 85 8	272	
5204275	2146 29 0	260	LVI322502	5539056	2153 98 2	311	1156038	5214335	2222 11 6	270		5220039	2228 90 4	272	
5595892	2146 32 0	260	LVI322502	5539117	2153 98 4	311	1156040	5214397	2222 12 4	270					
5204398	2146 36 3	260	LVI322502	5539179	2153 98 6	311	1156042	5214458	2222 14 0	270		5336372	2232 14 6	273	
5595953	2146 44 4	260	LVI322503	5539230	2153 99 2	312	1156050	5214519	2222 16 7	270		5336310	2232 17 0	273	
5204510	2146 48 7	260	LVI322503	5539292	2153 99 4	312	1156052	5214571	2222 17 5	270		5336198	2232 21 9	273	
5016069	2146 50 9	260	LVI322500	5539599	2153 99 6	312	1156054	5698357	2222 80 9	271		5336136	2232 23 5	273	
5016113	2146 51 1	260	LVI322500	5539650	2153 99 8	312	1156056	5705796	2222 83 3	271		5335955	2232 31 6	273	
								5705734	2222 84 1	271					
5844518	2148 02 1	261		5482895	2154 50 1	312	FI 1339916	5707837	2222 86 8	271		5221173	2236 02 8	297	
5844570	2148 04 8	261		5483014	2154 52 8	312	FI 1339920	5509837	2222 87 6	271					
5844631	2148 05 6	261		5483076	2154 53 6	312	FI 1339925					5221296	2250 07 1	266	1339360
5863779	2148 50 1	261		5483137	2154 54 4	312	FI 1339932	5214878	2225 22 0	273		5221357	2250 13 6	266	1339361
5863830	2148 52 8	261						5214939	2225 23 9	273		5221418	2250 20 9	266	1339362
5863892	2148 53 6	261						5214991	2225 34 4	273		5221470	2250 24 1	266	1339363
5947899	2148 80 3	261	1317403	5206897	2157 12 8	269		5215059	2225 37 9	273		5221531	2250 30 6	266	1339364
5877691	2148 84 6	261	1317405	5206958	2157 17 9	269		5215110	2225 40 9	273		5221593	2250 43 8	266	1339365
5640035	2148 86 2	261	1317407	5207016	2157 24 1	269		5215172	2225 41 7	273					
				5207078	2157 34 9	269		5215233	2225 42 5	273		5221654	2251 25 6	345	
5583219	2149 00 4	258	1317356					5215295	2225 50 6	273					
5583936	2149 01 0	258	1317360	5207139	2158 12 4	269		5215356	2225 51 4	273		5222071	2254 01 8	344	
5583998	2149 01 6	258	1317365	5207191	2158 17 5	269		5215417	2225 52 2	273		5222132	2254 02 6	345	
5584056	2149 02 2	258	1317372	5207252	2158 24 8	269		5215530	2225 61 1	273		5222194	2254 03 4	345	
5584292	2149 02 8	258	1317374	5207313	2158 34 5	269		5215592	2225 63 8	273					
5588191	2149 03 4	258	1317375					5215714	2225 70 0	273		5222798	2255 01 4	345	
5588252	2149 04 0	258	1317376	5742999	2197 80 4	261		5215776	2225 71 9	273		5222859	2255 02 2	345	
5584353	2149 30 3	258		5742937	2197 81 2	261		5215837	2225 72 7	273		5905592	2255 40 5	345	
5585251	2149 30 9	258		5742630	2197 85 5	261	FI 1339413	5215899	2225 80 8	273					
5585312	2149 31 5	258		5742579	2197 86 3	261	FI 1339414	5215950	2225 81 6	273		5222972	2259 07 9	346	
5585435	2149 32 1	258						5216070	2225 90 5	273		5223092	2259 14 1	346	
5585497	2149 32 7	258		5036616	2204 00 0	276	1317435	5216131	2225 91 3	273		5223214	2259 23 0	346	
5585558	2149 33 3	258		5210672	2204 01 0	276	1317436					5223276	2259 28 1	346	
5585619	2149 33 9	258		5693253	2204 54 1	264		5216254	2226 01 4	273					
5585671	2149 35 1	258	1317336	5210917	2204 80 0	264	1317431	5216315	2226 02 2	273		5224297	2305 15 1	298	
5586036	2149 35 7	258	1317340	5210979	2204 81 9	264	1317433	5216438	2226 10 3	273		5224358	2305 23 2	298	
5586159	2149 36 3	258	1317345	5597490	2204 85 1	264		5216490	2226 11 1	273					
5586395	2149 36 9	258	1317352	5597551	2204 87 8	264		5216674	2226 21 9	273		5224419	2307 61 8	299	
5586456															

EAN-C.	Tuotenumero	Sida	snro-nr.	EAN-C.	Tuotenumero	Sida	snro-nr.	EAN-C.	Tuotenumero	Sida	snro-nr.	EAN-C.	Tuotenumero	Sida	snro-nr.
5227236	2332 17 5	294	FI 1317453	5248170	3117 15 4	380		5682455	3192 64 4	390	FI 1339555	5287537	3341 04 6	379	
5227298	2332 18 3	294		5248231	3117 18 9	380						5287599	3341 05 4	379	
5227359	2332 21 3	294						5274759	3195 00 7	389		5287650	3341 06 2	379	
5227410	2332 33 7	294	FI 1317454	5250272	3131 06 8	386		5274810	3195 01 5	389		5287711	3341 07 0	379	
5227472	2332 36 1	294	FI 1317455	5250333	3131 08 4	386		5274872	3195 02 3	389		5287773	3341 49 6	379	
5227533	2332 38 8	294	FI 1317456					5274933	3195 03 1	389		5287834	3341 60 7	379	
5227595	2332 50 7	294		5250395	3133 02 8	386		5274995	3195 05 8	389		5287896	3341 70 4	379	
5227656	2332 55 8	294		5250456	3133 03 6	386		5275053	3195 06 6	389		5287957	3341 80 1	379	
5227717	2332 57 4	294	FI 1317457	5250579	3133 23 0	386		5275114	3195 07 4	389		5288015	3341 90 9	379	
5819851	2332 62 0	294						5275176	3195 08 2	389		5288077	3341 99 2	379	
5819912	2332 65 5	294		5253211	3141 04 7	386		5275237	3195 20 1	389					
5819974	2332 66 3	294		5253334	3141 12 8	386		5275299	3195 22 8	389		5288138	3342 04 2	379	
5820031	2332 69 8	294		5119982	3141 13 6	386		5275350	3195 23 6	389		5288190	3342 05 0	379	
5820093	2332 70 1	294		5374671	3141 13 8	386		5275411	3195 24 4	389		5288251	3342 06 9	379	
5820154	2332 72 8	294		5123583	3141 14 0	386		5275473	3195 25 2	389		5288312	3342 07 7	379	
5820215	2332 75 2	294		5123644	3141 14 4	386		5275534	3195 26 0	389		5288374	3342 50 6	379	
				5253396	3141 20 9	386		5275596	3195 27 9	389		5288435	3342 60 3	379	
5228011	2340 03 8	233		5895152	3141 23 3	386		5275657	3195 28 7	389		5288497	3342 70 0	379	
				5253457	3141 30 6	386		5275718	3195 42 2	389		5288558	3342 80 8	379	
				5023456	3141 31 0	386		5275770	3195 43 0	389					
5228073	2341 01 8	297		5023579	3141 31 2	386		5275831	3195 44 9	389		5289272	3347 05 2	379	
5228196	2341 10 7	297		5594437	3141 31 4	386		5275893	3195 45 7	389		5289333	3347 06 0	379	
								5275954	3195 46 5	389		5289395	3347 07 9	379	
				5255437	3156 14 1	391		5276012	3195 47 3	389					
5828198	2347 22 9	382		5255499	3156 20 6	391		5276074	3195 63 5	389		5291374	3353 16 8	378	
5828259	2347 26 1	382		5255550	3156 25 7	391		5276135	3195 64 3	389		5291435	3353 18 4	378	
5448099	2347 40 7	381		5255611	3156 30 3	391		5276197	3195 65 1	389		5291497	3353 23 0	378	
5625650	2347 52 3	381		5255673	3156 35 4	391		5276258	3195 67 8	389		5291558	3353 30 3	378	
5228738	2347 53 9	381		5255734	3156 40 0	391		5276319	3195 68 6	389		5291619	3353 40 0	378	
5084969	2347 54 7	381						5321019	3195 69 4	389		5291671	3353 50 8	378	
5084990	2347 55 5	381		5256212	3158 20 9	391		5682875	3195 91 0	389		5291732	3353 60 5	378	
5625667	2347 57 0	381		5256274	3158 24 1	391		5682813	3195 92 9	389					
				5256335	3158 30 6	391		5682752	3195 93 7	389		5291916	3354 16 4	378	
				5256458	3158 40 3	391		5682691	3195 94 5	389		5291978	3354 18 0	378	
5228851	2349 04 3	381	1339960	5256519	3158 50 0	391						5292036	3354 23 7	378	
5228912	2349 05 1	381	1339961					5552017	3198 01 6	389		5292098	3354 29 6	378	
5228974	2349 07 8	381						5552079	3198 01 8	389		5292159	3354 40 7	378	
5229032	2349 08 6	381	1339962	5256816	3160 20 3	391		5552130	3198 02 0	389		5292210	3354 50 4	378	
5229155	2349 10 8	381	1339963	5256939	3160 30 0	391		5552192	3198 02 2	389		5292272	3354 60 1	378	
5229216	2349 12 4	381	1339964	5257059	3160 40 8	391		5552253	3198 02 4	389					
				5257110	3160 50 5	391		5552314	3198 02 6	389		5292999	3360 12 1	378	
5874454	2350 80 7	381	1339980	5257172	3160 60 2	391		5552376	3198 03 0	389		5293118	3360 16 4	378	
								5552437	3198 03 2	389		5293170	3360 18 0	378	
5229452	2351 02 1	381	1339970	5257592	3162 30 3	391		5555438	3198 03 4	389		5293231	3360 23 7	378	
5669197	2351 05 6	265		5257714	3162 40 0	391		5555551	3198 03 6	389		5293293	3360 29 6	378	
5669197	2351 05 6	381		5257776	3162 50 8	391		5557111	3198 03 8	389		5293354	3360 40 7	378	
5229513	2351 06 4	265	1339971					5557418	3198 04 0	389		5293415	3360 50 4	378	
5229513	2351 06 4	381	1339971	5866718	3188 04 3	391		5558132	3198 04 2	389		5293477	3360 60 1	378	
5229575	2351 09 9	381	1339972	5270195	3188 05 1	391		5558378	3198 04 4	389					
5229636	2351 21 8	381		5270256	3188 07 8	391		5558491	3198 05 4	389		5293651	3361 12 8	378	
5242352	2351 41 2	262	1317470	5866770	3188 09 4	391		5558972	3198 05 6	389		5293774	3361 16 0	378	
5708971	2351 60 9	261		5866831	3188 14 0	391		5559030	3198 05 8	389		5293835	3361 18 7	378	
				5866893	3188 15 9	391		5560296	3198 06 0	389		5293897	3361 23 3	378	
				5270317	3188 16 7	391		5560357	3198 06 2	389		5293958	3361 30 6	378	
5230113	2357 05 4	283		5270379	3188 17 5	391		5628750	3198 07 3	389		5294078	3361 40 3	378	
				5866954	3188 18 3	391		5628873	3198 07 5	389		5294139	3361 50 0	378	
				5867012	3188 20 5	391		5628996	3198 07 7	389		5294191	3361 60 8	378	
5577768	2363 01 0	185	5234100	5867074	3188 25 6	391		5785835	3198 07 9	389					
				5270430	3188 27 2	391		5785897	3198 08 1	389		5294313	3366 11 1	379	
5686354	2363 01 5	185		5270492	3188 28 0	391		5797593	3198 19 3	390		5294436	3366 16 2	379	
				5867135	3188 30 2	391		5797777	3198 19 7	390		5294498	3366 18 9	379	
5687771	2363 01 9	185		5270553	3188 36 1	391		5797951	3198 19 9	390		5294559	3366 23 5	379	
				5270614	3188 38 8	391		5560470	3198 21 9	390		5294610	3366 30 8	379	
								5560531	3198 22 1	390	FI 1339529	5294733	3366 40 5	379	
5864974	3010 10 4	212		5271932	3192 11 3	390	FI 1339529	5561132	3198 22 3	390	FI 1339530	5294795	3366 50 2	379	
5033912	3010 20 1	211		5271994	3192 12 1	390	FI 1339530	5561378	3198 22 5	390	FI 1339531	5294856	3366 59 6	379	
5034032	3010 23 6	211		5272052	3192 14 8	390	FI 1339531	5561439	3198 22 7	390					
5034094	3010 24 4	211		5272113	3192 15 6	390	FI 1339532	5561552	3198 22 9	390					
5034155	3010 25 2	211		5272175	3192 16 4	390	FI 1339533	5561972	3198 23 1	390					
5034216	3010 26 0	211		5272236	3192 17 2	390	FI 1339534	5785958	3198 23 7	390					
5034278	3010 27 5	211		5272298	3192 21 0	390	FI 1339535	5562511	3198 23 9	390					
				5272359	3192 22 9	390	FI 1339536	5562573	3198 24 1	390		5294917	3367 12 6	379	
5241690	3031 01 2	380		5272410	3192 23 7	390	FI 1339537	5563112	3198 24 3	390		5295037	3367 16 9	379	
5851417	3031 50 0	380		5272472	3192 24 5	390	FI 1339538	5786078	3198 24 7	390		5295099	3367 18 5	379	
				5272533	3192 25 3	390	FI 1339539	5790037	3198 26 0	390		5295150	3367 23 1	379	
				5272595	3192 26 1	390	FI 1339540	5791232	3198 26 2	390		5295211	3367 30 4	379	
5245773	3100 15 4	380		5272717	3192 33 4	390	FI 1339542	5791294	3198 26 4	390		5295334	3367 40 1	379	
5245834	3100 18 9	380		5272779	3192 34 2	390	FI 1339543	5791539	3198 26 6	390		5295396	3367 50 9	379	
5245896	3100 25 1	380		5272830	3192 35 0	390	FI 1339544	5791713	3198 26 8	390					
5245957	3100 30 8	380		5272892	3192 36 9	390	FI 1339545	5792192	3198 27 6	390		5545590	3369 00 3	378	
5246015	3100 40 5	380		5272953	3192 37 7	390	FI 1339546	5792253	3198 27 8	390		5545774	3369 00 5	378	
5246077	3100 55 3	380		5273011	3192 41 5	390	FI 1339547	57							

Numeroluettelo

EAN-numeron rakenne: maatummus 40

valmistajan tunnus 1219 (tuotenumeroille, jotka alkavat numerolla 0 pätee: 1010)

yksilöllinen EAN-C 5647589

EAN-C.	Tuoteno	Sida	snro-nr.	EAN-C.	Tuoteno	Sida	snro-nr.	EAN-C.	Tuoteno	Sida	snro-nr.	EAN-C.	Tuoteno	Sida	snro-nr.
5298090	3400 06 9	391		5309550	3472 08 6	387		5415039	5303 21 4	298		6146833	7084 76 5	174	
5298151	3400 08 5	391						5415091	5303 22 2	298		6146895	7084 77 3	174	1464695
5298151	3400 08 5	324		5442936	3481 61 1	382		5415152	5303 23 0	298					
5298212	3400 10 7	324		5432852	3481 66 2	382		5415275	5303 25 7	298		5163305	7085 11 1	174	
5298212	3400 10 7	391		5432975	3481 77 8	383		5415336	5303 26 5	298		5163305	7085 11 1	167	
5298274	3400 12 3	391													
				5310631	3482 01 4	383		5647447	5303 76 7	301					
5299899	3402 04 5	392		5310693	3482 03 0	383									
5300014	3402 06 1	324		5310754	3482 05 7	383									
5300014	3402 06 1	392		5310815	3482 07 3	383		5417132	5305 01 2	299					
5300076	3402 08 8	324		5310877	3482 10 3	383									
5300076	3402 08 8	392		5310938	3482 13 8	383		5422594	5327 07 5	321					
5300137	3402 09 6	324		5310990	3482 15 4	383		5422655	5327 08 3	321					
5300137	3402 09 6	392		5239475	3482 70 7	383	1339950	5422716	5327 10 5	321					
5300199	3402 12 6	392		5239352	3482 75 8	383		5422778	5327 12 1	321					
5300311	3402 20 7	324	FI 1464238	5239291	3482 76 6	383		5422839	5327 14 8	321					
5300311	3402 20 7	392	FI 1464238												
5300373	3402 21 5	392		5311171	3483 06 1	382									
5300373	3402 21 5	324		5311232	3483 08 8	382		6933259	6006 48 6	175	1462325				
5300434	3402 22 3	392		5311294	3483 09 6	382									
5300434	3402 22 3	324		5418191	3483 21 4	382									
5300496	3402 30 4	392		5418207	3483 23 9	382		6006014	6007 24 4	334					
5300557	3402 31 2	392													
5300618	3402 32 0	392		5683414	3484 60 2	382		6006076	6007 25 2	334					
5300670	3402 33 9	392		5683353	3484 62 9	382		6006137	6007 26 0	334					
								6006199	6007 27 9	334					
5867913	3403 02 5	392		5454038	3492 03 6	383		6006250	6007 28 7	334					
5867975	3403 04 1	392		5454090	3492 06 0	383		6006311	6007 29 5	334					
5868033	3403 07 6	392		5454151	3492 09 5	383		6006373	6007 30 9	334					
5868095	3403 08 4	392						6006434	6007 31 7	334					
5868156	3403 09 2	392		5454397	3492 33 8	383									
5868217	3403 12 2	392		5454458	3492 36 2	383		5439479	6007 49 8	336					
5868279	3403 13 0	392		5454519	3492 39 7	383									
5868330	3403 16 5	392		5454212	3492 62 1	384									
				5454274	3492 66 4	384		6027132	6024 00 9	193					
5301578	3404 05 6	391		5454335	3492 69 9	384		6027439	6024 10 6	192					
5301639	3404 06 4	391													
5301691	3404 08 0	391						5406075	6119 94 0	194					
5301752	3404 10 2	391		5963929	3498 10 7	384	1462927	5406082	6119 94 1	194					
5301813	3404 12 9	391		5963981	3498 12 3	384	1462167	5406112	6119 94 3	194					
				5964049	3498 15 8	384		5406266	6119 94 5	194					
5302292	3405 06 0	392		5964100	3498 20 4	385		5406297	6119 94 6	194					
5302353	3405 08 7	392		5964162	3498 26 3	384		5406303	6119 94 7	194					
5302414	3405 10 9	392		5461890	3498 42 5	384	1462928	5406310	6119 95 0	197					
5302476	3405 12 5	392		5888437	3498 50 6	384		5406327	6119 95 1	197					
				5888499	3498 54 9	384		5406334	6119 95 2	197					
5303558	3415 03 1	386		5888550	3498 58 1	384	1462165								
5303619	3415 06 6	386		5888611	3498 65 4	384	1462166	6191710	6349 40 4	335	FI 1462440				
5303671	3415 08 2	386		5489139	3498 74 3	384		6191772	6349 41 2	335	FI 1462441				
5303732	3415 10 4	386						6191833	6349 43 9	335	FI 1462442				
5303794	3415 12 0	386		5464228	5300 01 5	301		6191895	6349 44 7	335	FI 1462443				
5303855	3415 14 7	386		5464266	5300 01 9	301		6191956	6349 46 3	335	FI 1462444				
5303916	3415 16 3	386		5413530	5300 03 7	298		6192076	6349 81 1	335					
				5413592	5300 05 3	298		6192199	6349 84 6	335					
5304333	3450 05 8	387	FI 1339517	5413653	5300 06 1	298		6192250	6349 85 4	335					
5304395	3450 06 6	387	FI 1339518	5413714	5300 08 8	298									
5304456	3450 07 4	387	FI 1339519	5647287	5300 21 0	301		6192311	6350 05 4	323					
5304517	3450 08 2	387	FI 1339520	5647317	5300 21 2	301		6192373	6350 10 0	323					
5304579	3450 09 0	387	FI 1339521	5647324	5300 21 4	301		6192496	6350 15 1	323	1464222				
5304630	3450 10 4	387	FI 1339522	5647331	5300 22 0	301									
5304692	3450 12 0	387	FI 1339523	5647348	5300 22 4	301		6192557	6350 20 8	323					
				5647355	5300 22 8	301									
5304753	3452 01 8	387	FI 1339524	5647362	5300 24 0	301									
				5647379	5300 24 4	301		6202218	6410 08 1	386	FI 1464252				
5513315	3453 82 0	387		5647386	5300 24 8	301		6202270	6410 10 3	386	1464253				
				5647393	5300 25 2	301		6202331	6410 11 1	386	1464254				
5305958	3460 06 1	387		5647409	5300 27 0	301		6043569	6410 15 4	386					
5306078	3460 16 9	387		5647416	5300 27 4	301		6043682	6410 16 2	386					
5306191	3460 76 2	388		5647423	5300 27 8	301		6043804	6410 17 0	386					
5306252	3460 78 9	388		5647430	5300 28 2	301									
5306498	3462 06 4	387		5413899	5301 00 9	298		6209354	6490 01 8	295	1317460				
5306559	3462 08 0	387		5413950	5301 03 3	298		6209415	6490 03 4	295					
5306979	3462 86 2	388		5414018	5301 04 1	298		6209477	6490 05 0	295					
5307037	3462 88 9	388		5414070	5301 06 8	298									
				5414193	5301 08 4	298		6209538	6490 10 7	295					
5307150	3463 06 0	388		5414315	5301 10 6	298		6209590	6490 12 3	295					
5307211	3463 56 7	388						6209651	6490 15 8	295					
5307273	3463 58 3	388		5414551	5302 02 1	299		6209712	6490 17 4	295					
				5414612	5302 05 6	299		6209774	6490 90 5	295					
5307334	3464 06 7	388		5414674	5302 06 4	299		6209835	6490 96 4	295	1317463				
5307396	3464 08 3	388		5414735	5302 08 0	299									
				5414797	5302 10 2	299									
5309253	3470 14 8	387	FI 1339504					6209897	6498 01 9	295					
5309314	3470 21 0	387	FI 1339505					6209958	6498 02 7	296	6401548				
5309376	3470 23 7	387	FI 1339506	5464273	5303 20 2	298									
				5414971	5303 20 6	298		6146833	7084 76 5	167					

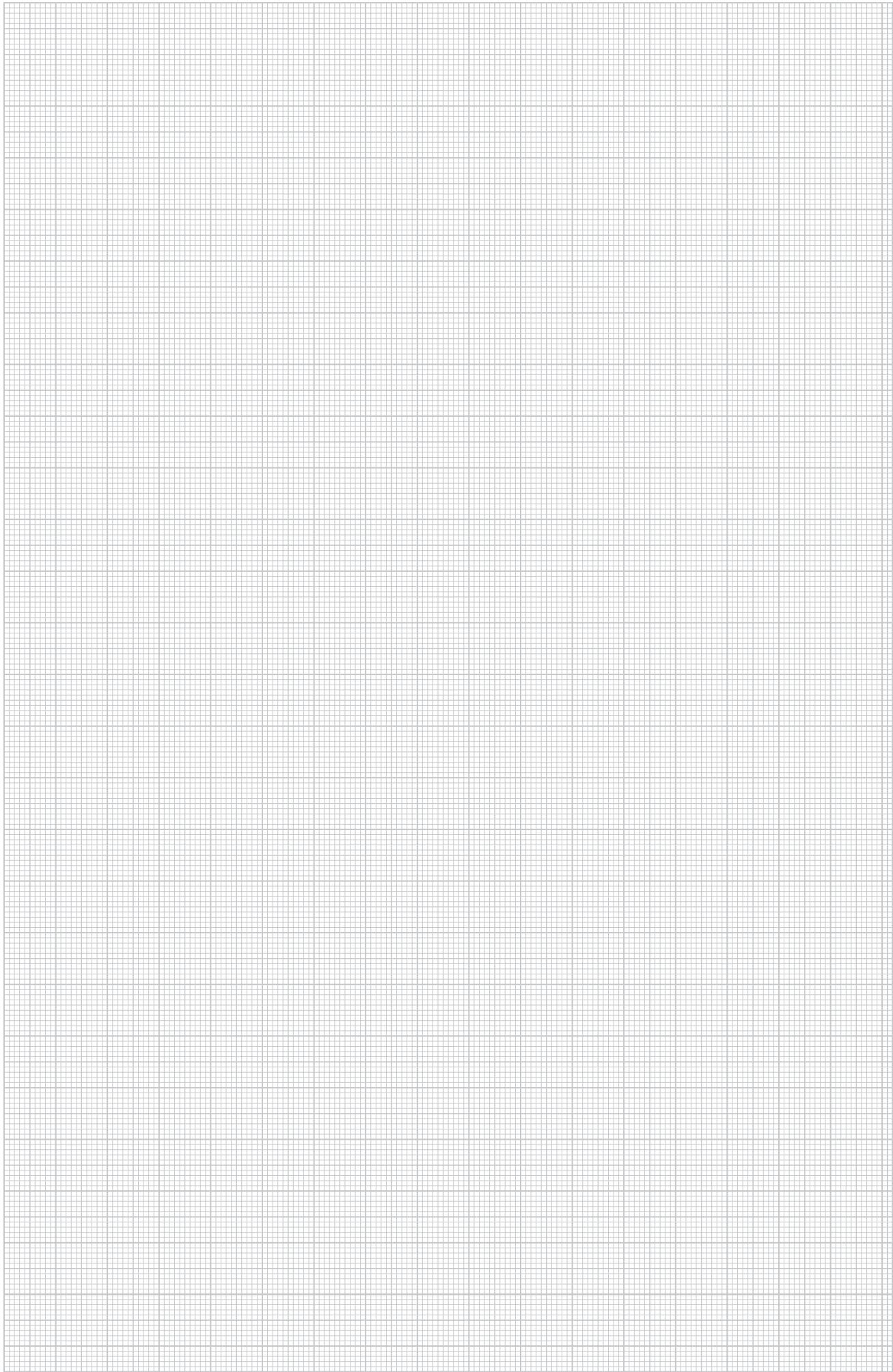

Tyyppiluettelo

EAN-numeron rakenne: maatumnus **40**

valmistajan tunnus **1219** (tuotenumeroille, jotka alkavat numerolla **0** pätee: **1010**)

yksilöllinen EAN-C **5647589**

Tyyppi	Mitat/väri/eril.	EAN-C.	Tuoteno	Side	Fl-nr.	Tyyppi	Mitat/väri/eril.	EAN-C.	Tuoteno	Side	Fl-nr.
60 N 12x16 BL	sininen 200 / PA	5183310	2054 08 6	200	1932568	106 B PG48 PS	Pg 48 vaaleanharmaa / PS	5173175	2036 49 5	217	
60 N 7x16 BL	sininen 100 / PA	5183198	2054 00 0	200	1932566	106 B PG9 PS	Pg 9 vaaleanharmaa / PS	5172154	2036 08 8	217	
60 S 12x16 GBGN	keltavihreä 200 / PA	5183372	2054 09 4	200	1932569	106 FL 16 8 19	Pg 166-8 / PE	5156734	2012 75 8	221	
60 S 7x16 GBGN	keltavihreä 100 / PA	5183259	2054 01 9	200	1932567	106 FL 21 10 29	Pg 218-10 / PE	5157090	2012 83 9	221	
							Pg 21 8,5-10,5 / PE	5157335	2012 87 1	221	
61 325 LGR	vaaleanharmaa 2000 / PA	5879916	2054 48 5	203	1339817	106 FL 21 12 35	Pg 219-12 / PE	5157151	2012 84 7	221	
							Pg 21 11-14 / PE	5157458	2012 92 8	221	
61 525 LGR	vaaleanharmaa 2000 / PA	5825319	2054 50 7	203	1339819	106 FL 21 6 30	Pg 214-6 / PE	5157212	2012 85 5	221	
							Pg 216-8 / PE	5156918	2012 78 2	221	
61 825 LGR	vaaleanharmaa 1000 / PA	5477976	2054 52 3	203	1339821	106 FL 21 9 22	Pg 217-9 / PE	5157038	2012 82 0	221	
							Pg 217-9 / PE	5156970	2012 80 4	221	
70 S	lajiteltu* 180 / PA	5183853	2055 20 1	200		106 FL 29 14 40	Pg 29 11-14 / PE	5156857	2012 77 4	221	
							M206-8 / PE	5515173	2013 00 2	220	
70 VDE	lajiteltu* 400 / PA	5183433	2055 02 3	200		106 FL M25 10 29	M258-10 / PE	5515470	2013 01 0	220	
							M25 10 31	5515531	2013 01 1	220	
71	musta 120 / PA	5183914	2055 50 3	200		106 FL M25 12 35	M259-12 / PE	5515593	2013 01 2	220	
							M25 11-14 / PE	5515654	2013 01 3	220	
72 CE SW	musta 500 / PP	5879251	2056 08 9	201		106 FL M25 6 30	M254-6 / PE	5515234	2013 00 6	220	
72 CE WS	valkoinen 500 / PP	5702610	2056 07 0	201		106 FL M25 8 33	M256-8 / PE	5515296	2013 00 7	220	
							M25 7-9 / PE	5515357	2013 00 8	220	
72 VDE	läpinäkyvä 500 / PA	5432258	2055 92 9	201		106 FL M25 9 39	M25 7-9 / PE	5515418	2013 00 9	220	
							M32 8-10 / PE	5515951	2013 01 9	220	
74 CE SW	musta 200 / PP	5879312	2056 23 2	202		106 FL M32 10 31	M328,5-10,5 / PE	5516019	2013 02 0	220	
74 CE WS	valkoinen 200 / PP	5702559	2056 22 4	202		106 FL M32 12 35	M329-12 / PE	5516071	2013 02 1	220	
							M32 11-14 / PE	5516132	2013 02 2	220	
74 D	läpinäkyvä 200 / PA	5184393	2056 17 8	201		106 FL M32 14 40	M324-6 / PE	5515715	2013 01 5	220	
							M326-8 / PE	5515777	2013 01 6	220	
74 VDE	läpinäkyvä 200 / PA	5184331	2056 14 3	201		106 FL M32 8 33	M327-9 / PE	5515838	2013 01 7	220	
							M32 7-9 / PE	5515890	2013 01 8	220	
76 CE SW	musta 100 / PP	5879374	2056 38 0	202		106 FL M40 10 29	M408-10 / PE	5516439	2013 02 9	220	
76 CE WS	valkoinen 100 / PP	5702498	2056 37 2	202		106 FL M40 10 31	M408,5-10,5 / PE	5516491	2013 03 0	220	
							M409-12 / PE	5516552	2013 03 1	220	
78 CE SW	musta 100 / PP	5879435	2056 56 9	202		106 FL M40 14 40	M40 11-14 / PE	5516613	2013 03 2	220	
78 CE WS	valkoinen 100 / PP	5702436	2056 55 0	202		106 FL M40 6 30	M404-6 / PE	5516194	2013 02 5	220	
							M406-8 / PE	5516255	2013 02 6	220	
79 CE SW	musta 50 / PP	5879558	2056 58 5	202		106 FL M40 8 33	M407-9 / PE	5516316	2013 02 7	220	
79 CE WS	valkoinen 50 / PP	5879497	2056 57 7	202		106 FL M40 9 22	M407-9 / PE	5516378	2013 02 8	220	
							M409-12 / PE	5516378	2013 02 8	220	
80 CE SW	musta 50 / PP	5300106	2056 59 3			106 K M20 PS	M20x1,5 vaaleanharmaa / PS	5469636	2038 07 2	216	
80 CE WS	valkoinen 50 / PP	5300069	2056 59 0			106 K PG16 PS	Pg 16 vaaleanharmaa / PS	5175216	2038 04 8	216	
						106 L PG11 PS	Pg 11 vaaleanharmaa / PS	5175810	2039 04 4	216	
89	PG 11 / PE	5156079	2012 03 0	164		106 L PG13.5 PS	Pg 13,5 vaaleanharmaa / PS	5175872	2039 06 0	216	
						106 L PG16 PS	Pg 16 vaaleanharmaa / PS	5175933	2039 08 7	216	
89 ROE 12-16	PG 13,5 / PE	5156130	2012 04 9	165		106 L PG21 PS	Pg 21 vaaleanharmaa / PS	5175995	2039 10 9	216	
						106 L PG29 PS	Pg 29 vaaleanharmaa / PS	5176053	2039 12 5	216	
						106 L PG9 PS	Pg 9 vaaleanharmaa / PS	5175759	2039 02 8	216	
90 M12 GE	M12 x 1,5 vaaleanharmaa / PE	5481454	2032 37 8	229		106 M 12 PA	M12 x 1,5 vaaleanharmaa / PA	5468134	2035 41 3	214	
90 M12 OF	M12 x 1,5 vaaleanharmaa / PE	5477556	2032 00 7	229		106 M 16 PA	M16 x 1,5 vaaleanharmaa / PA	5468370	2035 42 1	214	
90 M16 GE	M16 x 1,5 vaaleanharmaa / PE	5481515	2032 38 0	229		106 M 20 PA	M20 x 1,5 vaaleanharmaa / PA	5468431	2035 44 8	214	
90 M16 OF	M16 x 1,5 vaaleanharmaa / PE	5477617	2032 01 1	229		106 M 20 PS	M20 x 1,5 vaaleanharmaa / PS	5465256	2035 33 2	215	1729020
90 M20 GE	M20 x 1,5 vaaleanharmaa / PE	5481577	2032 38 2	229		106 M 25 PA	M25 x 1,5 vaaleanharmaa / PA	5468493	2035 45 6	214	
90 M20 OF	M20 x 1,5 vaaleanharmaa / PE	5477730	2032 01 5	229		106 M 25 PS	M25 x 1,5 vaaleanharmaa / PS	5465317	2035 34 0	215	1729025
90 M25 GE	M25 x 1,5 vaaleanharmaa / PE	5481638	2032 38 4	229		106 M 32 PA	M32 x 1,5 vaaleanharmaa / PA	5468554	2035 46 4	214	
90 M25 OF	M25 x 1,5 vaaleanharmaa / PE	5477792	2032 01 9	229		106 M 32 PS	M32 x 1,5 vaaleanharmaa / PS	5467410	2035 35 9	215	1729032
90 M32 GE	M32 x 1,5 vaaleanharmaa / PE	5481690	2032 38 6	229		106 M 40 PA	M40 x 1,5 vaaleanharmaa / PA	5468615	2035 47 2	214	
90 M32 OF	M32 x 1,5 vaaleanharmaa / PE	5477853	2032 02 3	229		106 M 40 PS	M40 x 1,5 vaaleanharmaa / PS	5467472	2035 36 7	215	1729040
90 M40 GE	M40 x 1,5 vaaleanharmaa / PE	5481812	2032 38 8	229		106 M 50 PA	M50 x 1,5 vaaleanharmaa / PA	5468677	2035 48 0	214	
90 M40 OF	M40 x 1,5 vaaleanharmaa / PE	5477914	2032 03 1	229		106 M 50 PS	M50 x 1,5 vaaleanharmaa / PS	5467953	2035 37 5	215	1729050
						106 M 63 PA	M63 x 1,5 vaaleanharmaa / PA	5468738	2035 49 9	214	
90 PG 9 DSMB	Pg 9 vaaleanharmaa / PE	5169819	2032 50 3	230		106 M 63 PS	M63 x 1,5 vaaleanharmaa / PS	5468011	2035 38 3	215	1729063
90 PG 9 OF	Pg 9 vaaleanharmaa / PE	5168973	2032 09 0	230		106 M12 PS	M12 x 1,5 vaaleanharmaa / PS	5464952	2035 31 6	215	1729012
90 PG11 DSMB	Pg 11 vaaleanharmaa / PE	5169871	2032 51 1	230		106 M16 PS	M16 x 1,5 vaaleanharmaa / PS	5465072	2035 32 4	215	1729016
90 PG11 OF	Pg 11 vaaleanharmaa / PE	5169031	2032 11 2	230		106 PG11	Pg 11 vaaleanharmaa / PS	5172277	2036 11 8	215	
90 PG13.5 DSMB	Pg 13,5 vaaleanharmaa / PE	5169932	2032 53 8	230		106 PG13.5	Pg 13,5 vaaleanharmaa / PS	5172390	2036 13 4	215	
90 PG13.5 OF	Pg 13,5 vaaleanharmaa / PE	5169093	2032 13 9	230		106 PG16	Pg 16 vaaleanharmaa / PS	5172574	2036 16 9	215	
90 PG16 DSMB	Pg 16 vaaleanharmaa / PE	5169994	2032 54 6	230		106 PG21	Pg 21 vaaleanharmaa / PS	5172635	2036 21 5	215	
90 PG16 OF	Pg 16 vaaleanharmaa / PE	5169154	2032 16 3	230		106 PG29	Pg 29 vaaleanharmaa / PS	5172758	2036 29 0	215	
90 PG21 DSMB	Pg 21 vaaleanharmaa / PE	5170051	2032 55 4	230		106 PG36	Pg 36 vaaleanharmaa / PS	5172871	2036 36 3	215	
90 PG21 OF	Pg 21 vaaleanharmaa / PE	5169215	2032 20 1	230		106 PG42	Pg 42 vaaleanharmaa / PS	5172994	2036 42 8	215	
90 PG29 DSMB	Pg 29 vaaleanharmaa / PE	5170112	2032 56 2	230		106 PG48	Pg 48 vaaleanharmaa / PS	5173113	2036 48 7	215	
						106 PG7	Pg 7 vaaleanharmaa / PS	5172093	2036 06 1	215	
106 B M16 PS	M16 x 1,5 vaaleanharmaa / PS	5520276	2035 51 0	217		106 PG9	Pg 9 vaaleanharmaa / PS	5172215	2036 09 6	215	
106 B M20 PS	M20 x 1,5 vaaleanharmaa / PS	5520337	2035 51 2	217		106 R PG13-11 PS	Pg 13,5 vaaleanharmaa / PS	5176954	2040 06 9	218	
106 B M25 PS	M25 x 1,5 vaaleanharmaa / PS	5520399	2035 51 4	217		106 R PG13-9 PS	Pg 13,5 vaaleanharmaa / PS	5176893	2040 04 2	218	
106 B M32 PS	M32 x 1,5 vaaleanharmaa / PS	5520450	2035 51 6	217		106 R PG16-11 PS	Pg 16 vaaleanharmaa / PS	5177012	2040 08 5	218	
106 B M40 PS	M40 x 1,5 vaaleanharmaa / PS	5520511	2035 51 8	217		106 R PG16-13 PS	Pg 16 vaaleanharmaa / PS	5177074	2040 10 7	218	
106 B M50 PS	M50 x 1,5 vaaleanharmaa / PS	5520573	2035 52 0	217		106 VDE PG11 PA	Pg 11 vaaleanharmaa / PA	5173359	2036 53 3	214	
106 B M63 PS	M63 x 1,5 vaaleanharmaa / PS	5520634	2035 52 2	217		106 VDE PG13 PA	Pg 13,5 vaaleanharmaa / PA	5173410	2036 57 6	214	
106 B PG11 PS	Pg 11 vaaleanharmaa / PS	5172338	2036 12 6	217		106 VDE PG16 PA	Pg 16 vaaleanharmaa / PA	5173472	2036 59 2	214	
106 B PG13.5 PS	Pg 13,5 vaaleanharmaa / PS	5172451	2036 14 2	217		106 VDE PG21 PA	Pg 21 vaaleanharmaa / PA	5173533	2036 61 4	214	
106 B PG16 PS	Pg 16 vaaleanharmaa / PS	5172512	2036 15 0	217		106 VDE PG29 PA	Pg 29 vaaleanharmaa / PA	5173595	2036 63 0	214	
106 B PG21 PS	Pg 21 vaaleanharmaa / PS	5172697	2036 22 3	217		106 VDE PG36 PA	Pg 36 vaaleanharmaa / PA	5173656	2036 65 7	214	
106 B PG29 PS	Pg 29 vaaleanharmaa / PS	5172819	2036 30 4	217		106 VDE PG9 PA	Pg 9 vaaleanharmaa / PA	5173298	2036 51 7	214	
106 B PG36 PS	Pg 36 vaaleanharmaa / PS	5172932	2036 37 1	217		106 Z PG11 PC	Pg 11 vaaleanharmaa / PC	5162070	2023 51 2	219	
106 B PG42 PS	Pg 42 vaaleanharmaa / PS	5173052	2036 43 6	217		106 Z PG13.5 PC					

Tyyppi	Mitat/väri/eril.	EAN-C.	Tuotenro	Side	Fl-nr.	Tyyppi	Mitat/väri/eril.	EAN-C.	Tuotenro	Side	Fl-nr.
106 Z PG16 PC	Pg 16 vaaleanharmaa/ PC	5162193	2023 53 9	219		107 E PG21 PA	Pg 21 vaaleanharmaa/ PA	5163879	2025 60 4	225	
106 Z PG21 PC	Pg 21 vaaleanharmaa/ PC	5162254	2023 54 7	219		107 E PG21 PS	Pg 21 vaaleanharmaa/ PS	5163275	2025 21 3	224	
106 Z PG9 PC	Pg 9 vaaleanharmaa/ PC	5162018	2023 50 4	219		107 E PG29 PS	Pg 29 vaaleanharmaa/ PS	5163336	2025 29 9	224	
106 ZB PG11 PC	Pg 11 vaaleanharmaa/ PC	5162438	2023 71 7	219		107 E PG36 PA	Pg 36 vaaleanharmaa/ PA	5163992	2025 64 7	225	
106 ZB PG16 PC	Pg 16 vaaleanharmaa/ PC	5162551	2023 73 3	219		107 E PG36 PS	Pg 36 vaaleanharmaa/ PS	5163398	2025 36 1	224	
106 ZB PG21 PC	Pg 21 vaaleanharmaa/ PC	5162612	2023 74 1	219		107 E PG42 PS	Pg 42 vaaleanharmaa/ PS	5163459	2025 42 6	224	
106 ZB PG29 PC	Pg 29 vaaleanharmaa/ PC	5162674	2023 76 8	219		107 E PG48 PS	Pg 48 vaaleanharmaa/ PS	5163510	2025 48 5	224	
106 ZB PG9 PC	Pg 9 vaaleanharmaa/ PC	5162377	2023 70 9	219		107 E PG7 PS	Pg 7 vaaleanharmaa/ PS	5162971	2025 07 8	224	
						107 E PG9 PS	Pg 9 vaaleanharmaa/ PS	5163039	2025 09 4	224	
106ZB PG13.5 PC	Pg 13,5 vaaleanharmaa/ PC	5162490	2023 72 5	219		107 EP PG29-36PA	Pg 29 Pg 36/ PA	5825012	2030 98 5	228	1711467
						107 EZ PG11-13PA	Pg 11 Pg 13,5/ PA	5433934	2030 93 4	228	1711463
107 ADA M12-PG9	M12 PG9/ PA	5371946	2031 45 6	228	1729633	107 EZ PG13-16PA	Pg 13,5 Pg 16/ PA	5433996	2030 95 0	228	1711464
107 ADA M16-PG9	M16 PG9/ PA	5371977	2031 45 7	228	1729634	107 EZ PG16-21PA	Pg 16 Pg 21/ PA	5434054	2030 97 7	228	1711465
107 ADA M20-PG11	M20 PG11/ PA	5371984	2031 45 8	228	1729637	107 EZ PG21-29PA	Pg 21 Pg 29/ PA	5434115	2030 99 3	228	1711466
107 ADA M20-PG13	M20 PG13,5/ PA	5371991	2031 45 9	228	1729638	107 EZ PG9-11 PA	Pg 9 Pg 11/ PA	5433873	2030 89 6	228	1711462
107 ADA M25-PG16	M25 PG16/ PA	5372004	2031 46 0	228	1729641	107 F M12 PE	M1216,3/ PE	5374299	2030 00 4	231	1729212
107 ADA M32-PG29	M32 PG29/ PA	5372011	2031 46 1	228	1729645	107 F M12 PE	M1216,3/ PE	5374299	2030 00 4	253	1729212
107 ADA M40-PG29	M40 PG29/ PA	5372028	2031 46 2	228	1729647	107 F M16 PE	M1620,9/ PE	5374350	2030 00 8	231	1729216
107 ADA M50-PG36	M50 PG36/ PA	5372035	2031 46 3	228	1729649	107 F M16 PE	M1620,9/ PE	5374350	2030 00 8	253	1729216
107 ADA PG11-M16	PG11 M16/ PA	5372066	2031 46 7	228	1729607	107 F M20 PE	M2025,1/ PE	5375678	2030 01 2	231	1729220
107 ADA PG13-M20	PG13,5 M20/ PA	5372073	2031 46 8	228	1729611	107 F M20 PE	M2025,1/ PE	5375678	2030 01 2	253	1729220
107 ADA PG16-M25	PG16 M20/ PA	5372080	2031 46 9	228	1729613	107 F M25 PE	M2531,3/ PE	5375913	2030 01 6	231	1729225
107 ADA PG21-M25	PG21 M25/ PA	5372097	2031 47 0	228	1729616	107 F M25 PE	M2531,3/ PE	5375913	2030 01 6	253	1729225
107 ADA PG29-M32	PG29 M32/ PA	5372103	2031 47 1	228	1729619	107 F M32 PE	M3237,6/ PE	5376156	2030 02 0	231	1729232
107 ADA PG7-M12	PG7 M12/ PA	5372042	2031 46 5	228	1729602	107 F M32 PE	M3237,6/ PE	5376156	2030 02 0	253	1729232
107 ADA PG9-M12	PG9 M12/ PA	5372059	2031 46 6	228	1729604	107 F M40 PE	M4049,1/ PE	5376514	2030 02 4	231	1729240
107 B PG11	Pg 11/ NBR-SBR	5167112	2029 11 1	230		107 F M40 PE	M4049,1/ PE	5376514	2030 02 4	253	1729240
107 B PG11	Pg 11/ NBR-SBR	5167112	2029 11 1	231		107 F M50 PE	M5060,1/ PE	5376576	2030 02 8	231	1729250
107 B PG11	Pg 11/ NBR-SBR	5167112	2029 11 1	252		107 F M50 PE	M5060,1/ PE	5376576	2030 02 8	253	1729250
107 B PG13.5	Pg 13,5/ NBR-SBR	5167174	2029 13 8	230		107 F M63 PE	M6373,8/ PE	5377290	2030 03 2	231	1729263
107 B PG13.5	Pg 13,5/ NBR-SBR	5167174	2029 13 8	231		107 F M63 PE	M6373,8/ PE	5377290	2030 03 2	253	1729263
107 B PG13.5	Pg 13,5/ NBR-SBR	5167174	2029 13 8	252		107 F PG11 PE	Pg 1123/ PE	5168317	2030 10 1	231	
107 B PG16	Pg 16/ NBR-SBR	5167235	2029 16 2	230		107 F PG11 PE	Pg 1123/ PE	5168317	2030 10 1	232	
107 B PG16	Pg 16/ NBR-SBR	5167235	2029 16 2	231		107 F PG11 PE	Pg 1123/ PE	5168317	2030 10 1	253	
107 B PG16	Pg 16/ NBR-SBR	5167235	2029 16 2	252		107 F PG13.5 PE	Pg 13,525/ PE	5168379	2030 13 6	231	
107 B PG21	Pg 21/ NBR-SBR	5167297	2029 21 9	230		107 F PG13.5 PE	Pg 13,525/ PE	5168379	2030 13 6	232	
107 B PG21	Pg 21/ NBR-SBR	5167297	2029 21 9	231		107 F PG13.5 PE	Pg 13,525/ PE	5168379	2030 13 6	253	
107 B PG21	Pg 21/ NBR-SBR	5167297	2029 21 9	252		107 F PG16 PE	Pg 1627/ PE	5168430	2030 16 0	231	
107 B PG29	Pg 29/ NBR-SBR	5167358	2029 29 4	230		107 F PG16 PE	Pg 1627/ PE	5168430	2030 16 0	232	
107 B PG29	Pg 29/ NBR-SBR	5167358	2029 29 4	231		107 F PG16 PE	Pg 1627/ PE	5168430	2030 16 0	253	
107 B PG29	Pg 29/ NBR-SBR	5167358	2029 29 4	252		107 F PG21 PE	Pg 2134/ PE	5168492	2030 21 7	231	
107 B PG36	Pg 36/ NBR-SBR	5167419	2029 36 7	230		107 F PG21 PE	Pg 2134/ PE	5168492	2030 21 7	232	
107 B PG36	Pg 36/ NBR-SBR	5167419	2029 36 7	231		107 F PG21 PE	Pg 2134/ PE	5168492	2030 21 7	253	
107 B PG36	Pg 36/ NBR-SBR	5167419	2029 36 7	252		107 F PG29 PE	Pg 2944/ PE	5168553	2030 29 2	231	
107 B PG42	Pg 42/ NBR-SBR	5167471	2029 42 1	230		107 F PG29 PE	Pg 2944/ PE	5168553	2030 29 2	232	
107 B PG42	Pg 42/ NBR-SBR	5167471	2029 42 1	231		107 F PG29 PE	Pg 2944/ PE	5168553	2030 29 2	253	
107 B PG42	Pg 42/ NBR-SBR	5167471	2029 42 1	252		107 F PG36 PE	Pg 3655,5/ PE	5168614	2030 36 5	231	
107 B PG48	Pg 48/ NBR-SBR	5167532	2029 48 0	230		107 F PG36 PE	Pg 3655,5/ PE	5168614	2030 36 5	232	
107 B PG48	Pg 48/ NBR-SBR	5167532	2029 48 0	231		107 F PG36 PE	Pg 3655,5/ PE	5168614	2030 36 5	253	
107 B PG48	Pg 48/ NBR-SBR	5167532	2029 48 0	252		107 F PG42 PE	Pg 4263,5/ PE	5168676	2030 41 1	231	
107 B PG9	Pg 9/ NBR-SBR	5167051	2029 10 3	230		107 F PG42 PE	Pg 4263,5/ PE	5168676	2030 41 1	232	
107 B PG9	Pg 9/ NBR-SBR	5167051	2029 10 3	231		107 F PG42 PE	Pg 4263,5/ PE	5168676	2030 41 1	253	
107 B PG9	Pg 9/ NBR-SBR	5167051	2029 10 3	252		107 F PG48 PE	Pg 4869,5/ PE	5168737	2030 48 9	231	
107 C V 16 2x6	Pg 166/ NBR-SBR	5824718	2029 63 4	212		107 F PG48 PE	Pg 4869,5/ PE	5168737	2030 48 9	232	
107 C V 16 3x5	Pg 165/ NBR-SBR	5824657	2029 62 6	212		107 F PG48 PE	Pg 4869,5/ PE	5168737	2030 48 9	253	
107 C V 16 3x6	Pg 166,5/ NBR-SBR	5824770	2029 64 2	212		107 F PG7 PE	Pg 716,5/ PE	5168195	2030 07 1	231	
107 C V 16 5x4	Pg 164/ NBR-SBR	5824596	2029 61 8	212		107 F PG7 PE	Pg 716,5/ PE	5168195	2030 07 1	232	
107 C V 21 2x8	Pg 218/ NBR-SBR	5824893	2029 66 9	212		107 F PG9 PE	Pg 919/ PE	5168256	2030 09 8	231	
107 C V 21 3x7	Pg 217/ NBR-SBR	5824831	2029 65 0	212		107 F PG9 PE	Pg 919/ PE	5168256	2030 09 8	232	
107 C VM 20 2x4	M204/ NBR-SBR	5035831	2029 67 2	212		107 F PG9 PE	Pg 919/ PE	5168256	2030 09 8	253	
107 C VM 20 2x6	M206/ NBR-SBR	5035954	2029 67 7	212		107 R M20-12 PA	M20 M12/ PA	5377412	2030 61 6	226	1729112
107 C VM 20 4x5	M205/ NBR-SBR	5035893	2029 67 5	212		107 R M20-16 PA	M20 M16/ PA	5383352	2030 61 9	226	1729116
107 C VM 25 2x6	M256/ NBR-SBR	5036135	2029 68 5	212		107 R M25-12 PA	M25 M12/ PA	5384076	2030 62 4	226	1729113
107 C VM 25 2x8	M258/ NBR-SBR	5036258	2029 69 0	212		107 R M25-16 PA	M25 M16/ PA	5389118	2030 62 6	226	1729117
107 C VM 25 3x6	M256/ NBR-SBR	5036074	2029 68 2	212		107 R M25-20 PA	M25 M20/ PA	5389170	2030 62 8	226	1729120
107 C VM 25 3x7	M257/ NBR-SBR	5036197	2029 68 8	212		107 R M32-12 PA	M32 M12/ PA	5394518	2030 63 2	226	1729114
107 C VM 25 5x4	M254/ NBR-SBR	5036012	2029 67 9	212		107 R M32-16 PA	M32 M16/ PA	5401711	2030 63 4	226	1729118
107 C VM 32 2x8	M328/ NBR-SBR	5036319	2029 69 3	212		107 R M32-20 PA	M32 M20/ PA	5402497	2030 63 7	226	1729121
107 C VM 32 4x8	M328/ NBR-SBR	5036371	2029 69 6	212		107 R M32-25 PA	M32 M25/ PA	5402558	2030 64 0	226	1729125
107 D PG11 GTP	Pg 1116,5/ St / GTP	5164890	2027 11 9	253		107 R M40-16 PA	M40 M16/ PA	5402619	2030 64 3	226	1729119
107 D PG13.5 GTP	Pg 13,518,5/ St / GTP	5164951	2027 13 5	253		107 R M40-20 PA	M40 M20/ PA	5402671	2030 64 6	226	1729122
107 D PG16 GTP	Pg 1620,5/ St / GTP	5165019	2027 15 1	253		107 R M40-25 PA	M40 M25/ PA	5402732	2030 64 9	226	1729126
107 D PG21 GTP	Pg 2126/ St / GTP	5165071	2027 21 6	253		107 R M40-32 PA	M40 M32/ PA	5402794	2030 65 2	226	1729132
107 D PG29 GTP	Pg 2935/ St / GTP	5165132	2027 29 1	253		107 R M50-20 PA	M50 M20/ PA	5402978	2030 65 5	226	1729123
107 D PG7 GTP	Pg 711/ St / GTP	5164777	2027 07 0	253		107 R M50-25 PA	M50 M25/ PA	5403517	2030 65 9	226	1729127
107 D PG9 GTP	Pg 913,5/ St / GTP	5164838	2027 09 7	253		107 R M50-32 PA	M50 M32/ PA	5403999	2030 66 1	226	1729133
107 E M 12-16 PA	M12 M16/ PA	5371878	2031 45 0	227	1729680	107 R M50-40 PA	M50 M40/ PA	5404118	2030 66 4	226	1729140
107 E M 16-20 PA	M16 M20/ PA	5371885	2031 45 1	227	1729681	107 R M63-25 PA	M63 M25/ PA	5405610	2030 66 7	226	1729128
107 E M 20-25 PA	M20 M25/ PA	5371									

Tyyppiluettelo

EAN-numeron rakenne: maatumus 40

valmistajan tunnus 1219 (tuotenumeroille, jotka alkavat numerolla 0 pätee: 1010)

yksilöllinen EAN-C 5647589

Tyyppi	Mitat/väri/eril.	EAN-C.	Tuoteno	Side	Fl-nr.	Tyyppi	Mitat/väri/eril.	EAN-C.	Tuoteno	Side	Fl-nr.
107 R PG21-11 PA	Pg 21 Pg 11/ PA	5907510	2030 76 4	227	1711446	107 V PG 7 PVC	Pg 7 11/ PVC	5167594	2029 70 7	232	
107 R PG21-13 PA	Pg 21 Pg 13,5/ PA	5434535	2030 77 2	227	1711447	107 V PG 7 PVC	Pg 7 11/ PVC	5167594	2029 70 7	233	
107 R PG21-16 PA	Pg 21 Pg 16/ PA	5434597	2030 78 0	227	1711448	107 V PG 7 PVC	Pg 7 11/ PVC	5167594	2029 70 7	255	
107 R PG29-16 PA	Pg 29 Pg 16/ PA	5824411	2030 79 9	227	1711449	107 V PG 9 PVC	Pg 9 13,5/ PVC	5167655	2029 71 5	232	
107 R PG29-21 PA	Pg 29 Pg 21/ PA	5434658	2030 80 2	227	1711450	107 V PG 9 PVC	Pg 9 13,5/ PVC	5167655	2029 71 5	233	
107 R PG36-21 PA	Pg 36 Pg 21/ PA	5824473	2030 82 9	227	1711451	107 V PG 9 PVC	Pg 9 13,5/ PVC	5167655	2029 71 5	255	
107 R PG36-29 PA	Pg 36 Pg 29/ PA	5434719	2030 81 0	227	1711452	107 V PG11 PVC	Pg 11 16,5/ PVC	5167716	2029 72 3	232	
107 R PG42-29 PA	Pg 42 Pg 29/ PA	5824534	2030 83 7	227	1711453	107 V PG11 PVC	Pg 11 16,5/ PVC	5167716	2029 72 3	233	
107 RZ PG 9-7	Pg 9 Pg 7/ PA	5445753	2031 30 2	227		107 V PG11 PVC	Pg 11 16,5/ PVC	5167716	2029 72 3	255	
107 RZ PG11-9	Pg 11 Pg 9/ PA	5445814	2031 32 9	227	1711441	107 V PG13,5 PVC	Pg 13,5 18,5/ PVC	5167778	2029 73 1	232	
107 RZ PG13-11	Pg 13,5 Pg 11/ PA	5445937	2031 34 5	227	1711454	107 V PG13,5 PVC	Pg 13,5 18,5/ PVC	5167778	2029 73 1	233	
107 RZ PG16-13	Pg 16 Pg 13,5/ PA	5446057	2031 38 8	227	1711455	107 V PG13,5 PVC	Pg 13,5 18,5/ PVC	5167778	2029 73 1	255	
107 RZ PG21-16	Pg 21 Pg 16/ PA	5446118	2031 41 8	227		107 V PG16 PVC	Pg 16 20,5/ PVC	5167839	2029 75 8	232	
107 RZ PG29-21	Pg 29 Pg 21/ PA	5446170	2031 44 2	227		107 V PG16 PVC	Pg 16 20,5/ PVC	5167839	2029 75 8	233	
107 S VTEC M12	M12 12/ ZPE	5035299	2028 87 0	212		107 V PG16 PVC	Pg 16 20,5/ PVC	5167839	2029 75 8	255	
107 S VTEC M12	M12 12/ ZPE	5035299	2028 87 0	213		107 V PG21 PVC	Pg 21 26/ PVC	5167891	2029 76 6	232	
107 S VTEC M12	M12 12/ ZPE	5035299	2028 87 0	232		107 V PG21 PVC	Pg 21 26/ PVC	5167891	2029 76 6	233	
107 S VTEC M12	M12 12/ ZPE	5035299	2028 87 0	254		107 V PG21 PVC	Pg 21 26/ PVC	5167891	2029 76 6	255	
107 S VTEC M16	M16 16/ ZPE	5035350	2028 87 3	212		107 V PG29 PVC	Pg 29 35/ PVC	5167952	2029 77 4	232	
107 S VTEC M16	M16 16/ ZPE	5035350	2028 87 3	213		107 V PG29 PVC	Pg 29 35/ PVC	5167952	2029 77 4	233	
107 S VTEC M16	M16 16/ ZPE	5035350	2028 87 3	232		107 V PG29 PVC	Pg 29 35/ PVC	5167952	2029 77 4	255	
107 S VTEC M16	M16 16/ ZPE	5035350	2028 87 3	254		107 W PG 9 PA	Pg 9 vaaleanharmaa / PA	5445395	2029 90 1	229	
107 S VTEC M20	M20 20/ ZPE	5035411	2028 87 5	212		107 W PG11 PA	Pg 11 vaaleanharmaa / PA	5445456	2029 92 8	229	
107 S VTEC M20	M20 20/ ZPE	5035411	2028 87 5	213		107 W PG13,5 PA	Pg 13,5 vaaleanharmaa / PA	5445517	2029 93 6	229	
107 S VTEC M20	M20 20/ ZPE	5035411	2028 87 5	232		107 W PG16 PA	Pg 16 vaaleanharmaa / PA	5445579	2029 94 4	229	
107 S VTEC M20	M20 20/ ZPE	5035411	2028 87 5	254		107 W PG21 PA	Pg 21 vaaleanharmaa / PA	5445630	2029 95 2	229	
107 S VTEC M25	M25 25/ ZPE	5035473	2028 87 7	212		107 Z PG 9 PA	Pg 9 vaaleanharmaa / PA	5161653	2023 09 1	225	
107 S VTEC M25	M25 25/ ZPE	5035473	2028 87 7	213		107 Z PG11 PA	Pg 11 vaaleanharmaa / PA	5161714	2023 11 3	225	
107 S VTEC M25	M25 25/ ZPE	5035473	2028 87 7	232		107 Z PG13,5 PA	Pg 13,5 vaaleanharmaa / PA	5161776	2023 12 1	225	
107 S VTEC M25	M25 25/ ZPE	5035473	2028 87 7	254		107 Z PG16 PA	Pg 16 vaaleanharmaa / PA	5161837	2023 16 4	225	
107 S VTEC M32	M32 32/ ZPE	5035534	2028 88 0	212		107 Z PG21 PA	Pg 21 vaaleanharmaa / PA	5161899	2023 21 0	225	
107 S VTEC M32	M32 32/ ZPE	5035534	2028 88 0	213		107 Z PG29 PA	Pg 29 vaaleanharmaa / PA	5161950	2023 29 6	225	
107 S VTEC M32	M32 32/ ZPE	5035534	2028 88 0	232		107CR VM 12	M12/ NBR-SBR	5360582	2029 56 0	212	
107 S VTEC M32	M32 32/ ZPE	5035534	2028 88 0	254		107CR VM 16	M16/ NBR-SBR	5360599	2029 56 3	212	
107 S VTEC M40	M40 40/ ZPE	5035596	2028 88 3	212		107CR VM 20	M20/ NBR-SBR	5360605	2029 56 6	212	
107 S VTEC M40	M40 40/ ZPE	5035596	2028 88 3	213		107CR VM 25	M25/ NBR-SBR	5360636	2029 56 9	212	
107 S VTEC M40	M40 40/ ZPE	5035596	2028 88 3	232		107CR VM 32	M32/ NBR-SBR	5360643	2029 57 2	212	
107 S VTEC M40	M40 40/ ZPE	5035596	2028 88 3	254		107CR VM 40	M40/ NBR-SBR	5360650	2029 57 5	212	
107 S VTEC M50	M50 50/ ZPE	5035718	2028 88 5	212		107CR VM 50	M50/ NBR-SBR	5360667	2029 57 8	212	
107 S VTEC M50	M50 50/ ZPE	5035718	2028 88 5	213		107CR VM 63	M63/ NBR-SBR	5360698	2029 58 1	212	
107 S VTEC M50	M50 50/ ZPE	5035718	2028 88 5	232		107VS VM 12 PM20 / Pg16 vaaleanharmaa / PA		5389972	2029 51 7	213	
107 S VTEC M50	M50 50/ ZPE	5035718	2028 88 5	254		107VS VM 16 PM25 / Pg21 vaaleanharmaa / PA		5389989	2029 52 0	213	
107 S VTEC M63	M63 63/ ZPE	5035770	2028 88 7	212		107VS VM 20 PM32 / Pg29 vaaleanharmaa / PA		5389996	2029 52 3	213	
107 S VTEC M63	M63 63/ ZPE	5035770	2028 88 7	213		107VS VM 5 PA M12 / Pg9 vaaleanharmaa / PA		5389934	2029 51 1	213	
107 S VTEC M63	M63 63/ ZPE	5035770	2028 88 7	232		107VS VM 9 PA M16 / Pg13,5 vaaleanharmaa / PA		5389941	2029 51 4	213	
107 S VTEC M63	M63 63/ ZPE	5035770	2028 88 7	254		108 M12 PS	M12 x 1,5 15/ PS	5409274	2033 00 3	224	1729014
107 S VTEC PG11	Pg 11 16,5/ ZPE	5843672	2028 91 3	213		108 M16 PS	M16 x 1,5 20/ PS	5424031	2033 00 7	224	1729018
107 S VTEC PG11	Pg 11 16,5/ ZPE	5843672	2028 91 3	232		108 M20 PS	M20 x 1,5 24/ PS	5426554	2033 01 1	224	1729022
107 S VTEC PG11	Pg 11 16,5/ ZPE	5843672	2028 91 3	254		108 M25 PS	M25 x 1,5 30/ PS	5426615	2033 01 6	224	1729027
107 S VTEC PG13	Pg 13,5 18,5/ ZPE	5843733	2028 92 1	212		108 M32 PS	M32 x 1,5 37/ PS	5431299	2033 02 1	224	1729034
107 S VTEC PG13	Pg 13,5 18,5/ ZPE	5843733	2028 92 1	232		108 M40 PS	M40 x 1,5 46/ PS	5434177	2033 02 6	224	1729042
107 S VTEC PG13	Pg 13,5 18,5/ ZPE	5843733	2028 92 1	254		108 M50 PS	M50 x 1,5 56/ PS	5452478	2033 03 2	224	1729052
107 S VTEC PG16	Pg 16 21/ ZPE	5843795	2028 94 8	213		108 M63 PS	M63 x 1,5 70/ PS	5464778	2033 03 8	224	1729065
107 S VTEC PG16	Pg 16 21/ ZPE	5843795	2028 94 8	232		108 PG 7	Pg 7 14/ PS	5170235	2033 07 0	224	1711422
107 S VTEC PG16	Pg 16 21/ ZPE	5843795	2028 94 8	254		108 PG 9	Pg 9 19/ PS	5170297	2033 09 7	224	1711423
107 S VTEC PG21	Pg 21 26,5/ ZPE	5843856	2028 95 6	212		108 PG 11	Pg 11 22/ PS	5170358	2033 11 9	224	1711424
107 S VTEC PG21	Pg 21 26,5/ ZPE	5843856	2028 95 6	232		108 PG13.5	Pg 13,5 25/ PS	5170419	2033 13 5	224	1711425
107 S VTEC PG21	Pg 21 26,5/ ZPE	5843856	2028 95 6	254		108 PG16	Pg 16 27/ PS	5170471	2033 15 1	224	1711426
107 S VTEC PG29	Pg 29 34,5/ ZPE	5843917	2028 96 4	213		108 PG21	Pg 21 34/ PS	5170532	2033 21 6	224	1711427
107 S VTEC PG29	Pg 29 34,5/ ZPE	5843917	2028 96 4	232		108 PG29	Pg 29 44/ PS	5170594	2033 29 1	224	1711428
107 S VTEC PG29	Pg 29 34,5/ ZPE	5843917	2028 96 4	254		108 PG36	Pg 36 58/ PS	5170655	2033 36 4	224	1711429
107 S VTEC PG29	Pg 29 34,5/ ZPE	5843917	2028 96 4	233		108 PG42	Pg 42 67/ PS	5170716	2033 42 9	224	1711430
107 S VTEC PG29	Pg 29 34,5/ ZPE	5843917	2028 96 4	254		108 PG48	Pg 48 73/ PS	5170778	2033 48 8	224	1711431
107 S VTEC PG36	Pg 36 44/ ZPE	5843979	2028 97 2	213		113 M20 LGR	M 20 x 1,5/ UF	5088639	2024 06 3	220	
107 S VTEC PG36	Pg 36 44/ ZPE	5843979	2028 97 2	233		113 PG13,5 LGR	Pg 13,5/ UF	5162858	2024 13 6	219	
107 S VTEC PG36	Pg 36 44/ ZPE	5843979	2028 97 2	254		113 PG16 LGR	Pg 16/ UF	5162919	2024 16 0	219	
107 S VTEC PG42	Pg 42 50/ ZPE	5844037	2028 98 0	213		115 GR-GN	väriltön 90	5228011	2340 03 8	233	
107 S VTEC PG42	Pg 42 50/ ZPE	5844037	2028 98 0	232							
107 S VTEC PG42	Pg 42 50/ ZPE	5844037	2028 98 0	254							
107 S VTEC PG48	Pg 48 56/ ZPE	5844099	2028 99 9	213							
107 S VTEC PG48	Pg 48 56/ ZPE	5844099	2028 99 9	232		116 M12 LGR PA	M12x1,5 vaaleanharmaa / PA	5874157	2048 90 6	222	1729013
107 S VTEC PG48	Pg 48 56/ ZPE	5844099	2028 99 9	254		116 M12 LGR PSM12 x 1,5 vaaleanharmaa / PS		5128656	2049 50 3	223	
107 S VTEC PG48	Pg 48 56/ ZPE	5844099	2028 99 9	233		116 M12 SGR PA	M12x1,5 hopeanharmaa / PA	5446477	2048 75 2	222	
107 S VTEC PG7	Pg 7 11/ ZPE	5843559	2028 89 1	213		116 M12 SW PA	M12x1,5 musta / PA	5089179	2049 06 6	222	
107 S VTEC PG7	Pg 7 11/ ZPE	5843559	2028 89 1	232		116 M16 LGR PA	M16x1,5 vaaleanharmaa / PA	5874218	2048 91 4	222	1729017
107 S VTEC PG7	Pg 7 11/ ZPE	5843559	2028 89 1	254		116 M16 LGR PSM16 x 1,5 vaaleanharmaa / PS		5139331	2049 51 1	223	
107 S VTEC PG7	Pg 7 11/ ZPE	5843559	2028 89 1	233		116 M16 SGR PA	M16x1,5 hopeanharmaa / PA	5446538	2048 76 0	222	
107 S VTEC PG9	Pg 9 14/ ZPE	5843610	2028 90 5	213		116 M16 SW PA	M16x1,5 musta / PA	5095354	2049 07 4	222	

Tyyppi	Mitat/väri/eril.	EAN-C.	Tuoteno	Side	Fl-nr.	Tyyppi	Mitat/väri/eril.	EAN-C.	Tuoteno	Side	Fl-nr.
116 M20 SW PA	M20x1,5 musta / PA	5095415	2049 08 2	222		158 MS PG11	Pg 11 / CuZn / N	5181330	2045 11 7	244	1711474
116 M25 LGR PA	M25x1,5 vaaleanharmaa / PA	5944591	2048 93 0	222	1729026	158 MS PG11	Pg 11 / CuZn / N	5181330	2045 11 7	245	1711474
116 M25 LGR PSM25 x 1,5 vaaleanharmaa / PS	5155478	2049 54 6	222		158 MS PG13.5	Pg 13,5 / CuZn / N	5181392	2045 13 3	244	1711475	
116 M25 SGR PA	M25x1,5 hopeanharmaa / PA	5446651	2048 78 7	223		158 MS PG13.5	Pg 13,5 / CuZn / N	5181392	2045 13 3	245	1711475
116 M25 SW PA	M25x1,5 musta / PA	5095538	2049 09 0	222		158 MS PG16	Pg 16 / CuZn / N	5181453	2045 16 8	244	1711476
116 M32 LGR PA	M32x1,5 vaaleanharmaa / PA	5944652	2048 94 9	222	1729033	158 MS PG16	Pg 16 / CuZn / N	5181453	2045 16 8	245	1711476
116 M32 LGR PSM32 x 1,5 vaaleanharmaa / PS	5161592	2049 55 4	223		158 MS PG21	Pg 21 / CuZn / N	5181514	2045 21 4	244	1711477	
116 M32 SGR PA	M32x1,5 hopeanharmaa / PA	5446712	2048 79 5	222		158 MS PG21	Pg 21 / CuZn / N	5181514	2045 21 4	245	1711477
116 M32 SW PA	M32x1,5 musta / PA	5095651	2049 10 4	222		158 MS PG29	Pg 29 / CuZn / N	5181576	2045 28 1	244	1711478
116 M40 LGR PA	M40x1,5 vaaleanharmaa / PA	5088998	2048 95 7	222	1729041	158 MS PG29	Pg 29 / CuZn / N	5181576	2045 28 1	245	1711478
116 M40 LGR PSM40 x 1,5 vaaleanharmaa / PS	5228615	2049 56 2	223		158 MS PG36	Pg 36 / CuZn / N	5181637	2045 36 2	244	1711479	
116 M40 SGR PA	M40x1,5 hopeanharmaa / PA	5088752	2048 80 9	222		158 MS PG36	Pg 36 / CuZn / N	5181637	2045 36 2	245	1711479
116 M40 SW PA	M40x1,5 musta / PA	5095712	2049 11 2	222							
116 M50 LGR PA	M50x1,5 vaaleanharmaa / PA	5089056	2048 96 5	222	1729051	159 MS PG 7	Pg 7 / CuZn / N	5181811	2046 07 5	245	
116 M50 LGR PSM50 x 1,5 vaaleanharmaa / PS	5232810	2049 57 0	223		159 MS PG 9	Pg 9 / CuZn / N	5181873	2046 09 1	245		
116 M50 SGR PA	M50x1,5 hopeanharmaa / PA	5088875	2048 81 7	222		159 MS PG11	Pg 11 / CuZn / N	5181934	2046 11 3	245	
116 M50 SW PA	M50x1,5 musta / PA	5096313	2049 12 0	222		159 MS PG13.5	Pg 13,5 / CuZn / N	5181996	2046 12 1	245	
116 M63 LGR PA	M63x1,5 vaaleanharmaa / PA	5089117	2048 97 3	222	1729064	159 MS PG16	Pg 16 / CuZn / N	5182054	2046 16 4	245	
116 M63 LGR PSM63 x 1,5 vaaleanharmaa / PS	5315018	2049 58 9	223		159 MS PG21	Pg 21 / CuZn / N	5182115	2046 21 0	245		
116 M63 SGR PA	M63x1,5 hopeanharmaa / PA	5088936	2048 82 5	222		159 MS PG29	Pg 29 / CuZn / N	5182177	2046 29 6	245	
116 M63 SW PA	M63x1,5 musta / PA	5127758	2049 13 9	222		159 MS PG36	Pg 36 / CuZn / N	5182238	2046 36 9	245	
116 PG 7	Pg 7 vaaleanharmaa / PS	5178811	2043 07 6	223		159 MS PG42	Pg 42 / CuZn / N	5182290	2046 42 3	245	
116 PG 9	Pg 9 vaaleanharmaa / PS	5178873	2043 09 2	223		159 MS PG48	Pg 48 / CuZn / N	5182351	2046 48 2	245	
116 PG11	Pg 11 vaaleanharmaa / PS	5178934	2043 11 4	223							
116 PG13.5	Pg 13,5 vaaleanharmaa / PS	5178996	2043 13 0	223		160 G MS PG 9	Pg 9 / CuZn / N	5186014	2080 70 2	240	
116 PG16	Pg 16 vaaleanharmaa / PS	5179054	2043 16 5	223		160 G MS PG11	Pg 11 / CuZn / N	5186076	2080 72 9	240	
116 PG21	Pg 21 vaaleanharmaa / PS	5179115	2043 21 1	223		160 G MS PG13.5	Pg 13,5 / CuZn / N	5186137	2080 74 5	240	
116 PG29	Pg 29 vaaleanharmaa / PS	5179177	2043 29 7	223		160 G MS PG16	Pg 16 / CuZn / N	5186199	2080 76 1	240	
116 PG36	Pg 36 vaaleanharmaa / PS	5179238	2043 35 1	223		160 G MS PG21	Pg 21 / CuZn / N	5186250	2080 79 6	240	
116 PG42	Pg 42 vaaleanharmaa / PS	5179290	2043 42 4	223		160 L MS PG 7	Pg 7 / CuZn / N	5186373	2081 07 5	240	
116 PG48	Pg 48 vaaleanharmaa / PS	5179351	2043 48 3	223		160 L MS PG 9	Pg 9 / CuZn / N	5186434	2081 09 1	240	
116 VDE PG 9 PA	Pg 9 vaaleanharmaa / PA	5182474	2048 09 4	222	1711403	160 L MS PG11	Pg 11 / CuZn / N	5186496	2081 11 3	240	
116 VDE PG11 PA	Pg 11 vaaleanharmaa / PA	5182535	2048 11 6	222	1711404	160 L MS PG13.5	Pg 13,5 / CuZn / N	5186557	2081 14 8	240	
116 VDE PG13.5 PA	Pg 13,5 vaaleanharmaa / PA	5182597	2048 13 2	222	1711405	160 L MS PG16	Pg 16 / CuZn / N	5186618	2081 16 4	240	
116 VDE PG16 PA	Pg 16 vaaleanharmaa / PA	5182658	2048 16 7	222	1711406	160 L MS PG21	Pg 21 / CuZn / N	5186670	2081 21 0	240	
116 VDE PG21 PA	Pg 21 vaaleanharmaa / PA	5182719	2048 22 1	222	1711407	160 MS M12	M12 x 1,5 / CuZn / N	5478218	2079 80 1	239	1711212
116 VDE PG29 PA	Pg 29 vaaleanharmaa / PA	5182771	2048 29 9	222	1711408	160 MS M16	M16 x 1,5 / CuZn / N	5478935	2079 82 8	239	1711216
116 VDE PG36 PA	Pg 36 vaaleanharmaa / PA	5182832	2048 36 1	222	1711409	160 MS M20	M20 x 1,5 / CuZn / N	5478997	2079 83 6	239	1711220
116 VDE PG42 PA	Pg 42 vaaleanharmaa / PA	5182894	2048 42 6	222	1711410	160 MS M25	M25 x 1,5 / CuZn / N	5479055	2079 84 4	239	1711225
116 VDE PG48 PA	Pg 48 vaaleanharmaa / PA	5182955	2048 48 5	222	1711411	160 MS M32	M32 x 1,5 / CuZn / N	5479178	2079 85 2	239	1711232
116 VDE PG7 PA	Pg 7 vaaleanharmaa / PA	5182412	2048 07 8	222	1711402	160 MS M40	M40 x 1,5 / CuZn / N	5479239	2079 86 0	239	1711240
						160 MS M50	M50 x 1,5 / CuZn / N	5479291	2079 87 9	239	1711250
						160 MS M63	M63 x 1,5 / CuZn / N	5479352	2079 88 7	239	1711263
117 5x2,5	28 / PS	5159858	2022 02 8	183		160 MS PG 7	Pg 7 / CuZn / N	5185055	2080 07 9	239	1729422
117 5x6	33,5 / PS	5159919	2022 06 0	183		160 MS PG 9	Pg 9 / CuZn / N	5185116	2080 09 5	239	1729423
						160 MS PG11	Pg 11 / CuZn / N	5185178	2080 11 7	239	1729424
						160 MS PG13.5	Pg 13,5 / CuZn / N	5185239	2080 13 3	239	1729425
129 M16	M16 vaaleanharmaa / PE	5490753	2047 81 0	310		160 MS PG16	Pg 16 / CuZn / N	5185291	2080 16 8	239	1729426
129 M16 SW	M16 musta / PE	5468851	2047 93 4	310		160 MS PG21	Pg 21 / CuZn / N	5185352	2080 21 4	239	1729427
129 M20	M20 vaaleanharmaa / PE	5490692	2047 82 9	310		160 MS PG29	Pg 29 / CuZn / N	5185413	2080 28 1	239	1729428
129 M20 SW	M20 musta / PE	5468912	2047 94 2	310		160 MS PG36	Pg 36 / CuZn / N	5185475	2080 36 2	239	1729429
129 M25	M25 vaaleanharmaa / PE	5490630	2047 83 7	310		160 MS PG42	Pg 42 / CuZn / N	5185536	2080 42 7	239	1729430
129 M25 SW	M25 musta / PE	5468974	2047 95 0	310		160 MS PG48	Pg 48 / CuZn / N	5185598	2080 48 6	239	1729431
129 M32	M32 vaaleanharmaa / PE	5487692	2047 85 3	310							
129 M32 SW	M32 musta / PE	5469155	2047 96 9	310		161 MS M16	M16 x 1,5 / CuZn / N	5204558	2079 90 5	241	1711616
129 M40	M40 vaaleanharmaa / PE	5037699	2047 86 1	310		161 MS M20	M20 x 1,5 / CuZn / N	5514930	2079 90 9	241	1711620
129 M40 SW	M40 musta / PE	5469216	2047 97 7	310		161 MS M25	M25 x 1,5 / CuZn / N	5514992	2079 91 3	241	1711625
129 M50	M50 vaaleanharmaa / PE	5037637	2047 88 8	310		161 MS M32	M32 x 1,5 / CuZn / N	5203834	2079 91 7	241	1711632
129 M50 SW	M50 musta / PE	5469278	2047 98 5	310		161 MS M40	M40 x 1,5 / CuZn / N	5517399	2079 92 1	241	1711640
129 M63	M63 vaaleanharmaa / PE	5037576	2047 89 6	310		161 MS M50	M50 x 1,5 / CuZn / N	5517511	2079 92 5	241	1711650
129 M64 SW	M63 musta / PE	5469339	2047 99 3	310		161 MS M63	M63x1,5 / CuZn / N	5517634	2079 92 9	241	1711663
129 PG 9	Pg 9 vaaleanharmaa / PE	5180074	2044 09 9	310		161 MS PG11	Pg 11 / CuZn / N	5185659	2080 50 8	241	1711511
129 PG11	Pg 11 vaaleanharmaa / PE	5180135	2044 11 0	310		161 MS PG13.5	Pg 13,5 / CuZn / N	5185710	2080 52 4	241	1711513
129 PG13.5	Pg 13,5 vaaleanharmaa / PE	5180197	2044 13 7	310		161 MS PG16	Pg 16 / CuZn / N	5185772	2080 54 0	241	1711516
129 PG16	Pg 16 vaaleanharmaa / PE	5180258	2044 16 1	310		161 MS PG21	Pg 21 / CuZn / N	5185833	2080 56 7	241	1711521
129 PG16 SW	Pg 16 musta / PE	5180852	2044 66 8	310		161 MS PG29	Pg 29 / CuZn / N	5185895	2080 58 3	241	1711529
129 PG21	Pg 21 vaaleanharmaa / PE	5180319	2044 21 8	310		161 MS PG36	Pg 36 / CuZn / N	5185956	2080 60 5	241	1711536
129 PG21 SW	Pg 21 musta / PE	5180913	2044 71 4	310							
129 PG29	Pg 29 vaaleanharmaa / PE	5180371	2044 29 3	310		162 MS M16	M16 x 1,5 / CuZn / N	5517696	2083 71 2	242	
129 PG29 SW	Pg 29 musta / PE	5180975	2044 78 1	310		162 MS M20	M20 x 1,5 / CuZn / N	5517757	2083 71 6	242	
129 PG36	Pg 36 vaaleanharmaa / PE	5180432	2044 36 6	310		162 MS M25	M25 x 1,5 / CuZn / N	5517818	2083 72 0	242	
129 PG36 SW	Pg 36 musta / PE	5181033	2044 86 2	310		162 MS M32	M32 x 1,5 / CuZn / N	5517870	2083 72 4	242	
129 PG42	Pg 42 vaaleanharmaa / PE	5180494	2044 42 0	310		162 MS M40	M40 x 1,5 / CuZn / N	5517931	2083 72 8	242	
129 PG48	Pg 48 vaaleanharmaa / PE	5180555	2044 47 1	310		162 MS M50	M50 x 1,5 / CuZn / N	5517993	2083 73 2	242	
						162 MS M63	M63 x 1,5 / CuZn / N	5518051	2083 73 6	242	
157 MS PG 7	Pg 7 / CuZn / N	5157755	2013 06 1	248		162 MS PG 9	Pg 9 / CuZn / N	5582670	2082 51 9	242	
157 MS PG 9	Pg 9 / CuZn / N	5157816	2013 09 6	248		162 MS PG11	Pg 11 / CuZn / N	5187578	2082 50 0	242	
157 MS PG11	Pg 11 / CuZn / N	5157878	2013 11 8	248		162 MS PG13.5	Pg 13,5 / CuZn / N	5187639	2082 52 7	242	
157 MS PG13.5	Pg 13,5 / CuZn / N	5157939	2013 13 4	248		162 MS PG16	Pg 16 / CuZn / N	5187691	2082 54 3	242	
157 MS PG16	Pg 16 / CuZn / N	5157991	2013 16 9	248		162 MS PG21	Pg 21 / CuZn / N	5187752	2082 57 8	242	
157 MS PG21	Pg 21 / CuZn / N										

Tyyppiluettelo

EAN-numeron rakenne: maatumnus **40**

valmistajan tunnus **1219** (tuotenumeroille, jotka alkavat numerolla **0** pätee: **1010**)

yksilöllinen EAN-C **5647589**

Tyyppi	Mitat/väri/eril.	EAN-C.	Tuoteno	Side	Fl-nr.	Tyyppi	Mitat/väri/eril.	EAN-C.	Tuoteno	Side	Fl-nr.
163 G MS PG16	Pg 16/ CuZn / N	5188117	2082 74 8	244		165 MS EZPG9-11	Pg 9 Pg 11/ CuZn / N	5190875	2088 04 5	249	1729477
163 L MS PG 9	Pg 9/ CuZn / N	5188292	2083 09 4	244		165 MS EZPG9-13	Pg 9 Pg 13,5/ CuZn / N	5190936	2088 06 1	249	1729478
163 L MS PG11	Pg 11/ CuZn / N	5188353	2083 11 6	244		167 R MS M16-12	M16 M12/ CuZn / N	5475392	2089 50 5	249	1729508
163 L MS PG13	Pg 13,5/ CuZn / N	5188414	2083 13 2	244		167 R MS M20-12	M20 M12/ CuZn / N	5475453	2089 51 3	249	1729509
163 L MS PG16	Pg 16/ CuZn / N	5188476	2083 16 7	244		167 R MS M20-16	M20 M16/ CuZn / N	5475514	2089 52 1	249	1729510
163 L MS PG21	Pg 21/ CuZn / N	5188537	2083 21 3	244		167 R MS M25-16	M25 M16/ CuZn / N	5475576	2089 54 8	249	1729511
163 L MS PG29	Pg 29/ CuZn / N	5188599	2083 29 9	244		167 R MS M25-20	M25 M20/ CuZn / N	5475637	2089 55 6	249	1729512
163 MS M12	M12 x 1,5/ CuZn / N	5481331	2083 61 2	243		167 R MS M32-20	M32 M20/ CuZn / N	5475699	2089 56 4	249	1729513
163 MS M16	M16 x 1,5/ CuZn / N	5481393	2083 62 0	243		167 R MS M32-25	M32 M25/ CuZn / N	5475750	2089 57 2	249	1729514
163 MS M20	M20 x 1,5/ CuZn / N	5481874	2083 63 9	243		167 R MS M40-25	M40 M25/ CuZn / N	5475811	2089 58 0	249	1729515
163 MS M25	M25 x 1,5/ CuZn / N	5481997	2083 64 7	243		167 R MS M40-32	M40 M32/ CuZn / N	5475873	2089 59 9	249	1729516
163 MS M32	M32 x 1,5/ CuZn / N	5482055	2083 65 5	243		167 R MS M50-32	M50 M32/ CuZn / N	5476412	2089 60 2	249	1729517
163 MS M40	M40 x 1,5/ CuZn / N	5482116	2083 66 3	243		167 R MS M50-40	M50 M40/ CuZn / N	5476474	2089 61 0	249	1729518
163 MS M50	M50 x 1,5/ CuZn / N	5482178	2083 67 1	243		167 R MS M63-40	M63 M40/ CuZn / N	5476535	2089 62 9	249	1729519
163 MS M63	M63 x 1,5/ CuZn / N	5482239	2083 69 8	243		167 R MS M63-50	M63 M50/ CuZn / N	5476597	2089 63 7	249	1729520
163 MS PG 7	Pg 7/ CuZn / N	5186977	2082 07 1	243		167 R MS PG11-9	Pg 11 Pg 7/ CuZn / N	5192794	2089 04 1	250	1729489
163 MS PG 9	Pg 9/ CuZn / N	5187035	2082 09 8	243		167 R MS PG11-9	Pg 11 Pg 9/ CuZn / N	5192855	2089 07 6	250	1729490
163 MS PG11	Pg 11/ CuZn / N	5187097	2082 10 1	243		167 R MS PG13-11	Pg 13,5 Pg 11/ CuZn / N	5193036	2089 13 0	250	1729493
163 MS PG13.5	Pg 13,5/ CuZn / N	5187158	2082 13 6	243		167 R MS PG13-7	Pg 13,5 Pg 7/ CuZn / N	5192916	2089 09 2	250	1729491
163 MS PG16	Pg 16/ CuZn / N	5187219	2082 16 0	243		167 R MS PG13-9	Pg 13,5 Pg 9/ CuZn / N	5192978	2089 11 4	250	1729492
163 MS PG21	Pg 21/ CuZn / N	5187271	2082 21 7	243		167 R MS PG16-11	Pg 16 Pg 11/ CuZn / N	5193159	2089 17 3	250	1729495
163 MS PG29	Pg 29/ CuZn / N	5187332	2082 29 2	243		167 R MS PG16-13	Pg 16 Pg 13,5/ CuZn / N	5193210	2089 20 3	250	1729496
163 MS PG36	Pg 36/ CuZn / N	5187394	2082 36 5	243		167 R MS PG16-9	Pg 16 Pg 9/ CuZn / N	5193098	2089 15 7	250	1729494
163 MS PG42	Pg 42/ CuZn / N	5187455	2082 41 1	243		167 R MS PG21-11	Pg 21 Pg 11/ CuZn / N	5193272	2089 23 8	250	1729497
163 MS PG48	Pg 48/ CuZn / N	5187516	2082 48 9	243		167 R MS PG21-13	Pg 21 Pg 13,5/ CuZn / N	5193333	2089 25 4	250	1729498
164 MS PG11	Pg 11/ CuZn / N	5188834	2084 11 2	247		167 R MS PG21-13	Pg 21 Pg 16/ CuZn / N	5193395	2089 27 0	250	1729499
164 MS PG13	Pg 13,5/ CuZn / N	5188896	2084 13 9	247		167 R MS PG29-16	Pg 29 Pg 16/ CuZn / N	5193456	2089 29 7	250	1729500
164 MS PG16	Pg 16/ CuZn / N	5188957	2084 16 3	247		167 R MS PG29-21	Pg 29 Pg 21/ CuZn / N	5193517	2089 31 9	250	1729501
164 MS PG21	Pg 21/ CuZn / N	5189015	2084 20 1	247		167 R MS PG36-21	Pg 36 Pg 21/ CuZn / N	5193579	2089 33 5	250	1729502
164 MS PG29	Pg 29/ CuZn / N	5189077	2084 29 5	247		167 R MS PG36-29	Pg 36 Pg 29/ CuZn / N	5193630	2089 35 1	250	1729503
164 MS PG36	Pg 36/ CuZn / N	5189138	2084 36 8	247		167 R MS PG42-29	Pg 42 Pg 29/ CuZn / N	5193692	2089 38 6	250	1729504
164 MS PG42	Pg 42/ CuZn / N	5189190	2084 42 2	247		167 R MS PG42-36	Pg 42 Pg 36/ CuZn / N	5193753	2089 40 8	250	1729505
164 MS PG48	Pg 48/ CuZn / N	5189251	2084 48 1	247		167 R MS PG48-36	Pg 48 Pg 36/ CuZn / N	5193814	2089 42 4	250	1729506
						167 R MS PG48-42	Pg 48 Pg 42/ CuZn / N	5193876	2089 44 0	250	1729507
						167 R MS PG9-7	Pg 9 Pg 7/ CuZn / N	5192732	2089 02 5	250	1729488
165 ADA M 50-63	M50 M63/ CuZn / N	5372219	2088 28 6	248	1729747	168 MS M12	M12 x 1,5 16/ CuZn / N	5471738	2090 51 1	247	1729468
165 ADA M12-16	M12 M16/ CuZn / N	5372158	2088 28 0	248	1729743	168 MS M16	M16 x 1,5 20/ CuZn / N	5471790	2090 53 8	247	1729469
165 ADA M12-PG7	M12 PG7/ CuZn / N	5372325	2088 30 1	251	1729763	168 MS M20	M20 x 1,5 22/ CuZn / N	5472810	2090 54 6	247	1729470
165 ADA M16-20	M16 M20/ CuZn / N	5372165	2088 28 1	248	1729742	168 MS M25	M25 x 1,5 28/ CuZn / N	5472933	2090 55 4	247	1729471
165 ADA M16-PG11	M16 PG11/ CuZn / N	5372332	2088 30 2	251	1729766	168 MS M32	M32 x 1,5 35/ CuZn / N	5472995	2090 56 2	247	1729472
165 ADA M16-PG7	M16 PG7/ CuZn / N	5390923	2088 31 0	251		168 MS M40	M40 x 1,5 45/ CuZn / N	5473411	2090 57 0	247	1729473
165 ADA M16-PG9	M16 PG9/ CuZn / N	5390930	2088 31 2	251		168 MS M50	M50 x 1,5 55/ CuZn / N	5474012	2090 58 9	247	1729474
165 ADA M20-25	M20 M25/ CuZn / N	5372172	2088 28 2	248	1729743	168 MS M63	M63 x 1,5 68/ CuZn / N	5474074	2090 59 7	247	1729475
165 ADA M20-PG11	M20 PG11/ CuZn / N	5390954	2088 31 6	251		168 MS PG 7	Pg 7 14/ CuZn / N	5193937	2090 07 4	247	1729458
165 ADA M20-PG13	M20 PG13,5/ CuZn / N	5372349	2088 30 3	251	1729768	168 MS PG 9	Pg 9 17/ CuZn / N	5193999	2090 09 0	247	1729459
165 ADA M20-PG16	M20 PG16/ CuZn / N	5390961	2088 31 8	251		168 MS PG11	Pg 11 20/ CuZn / N	5194057	2090 11 2	247	1729460
165 ADA M20-PG9	M20 PG9/ CuZn / N	5390947	2088 31 4	251		168 MS PG13	Pg 13,5 22/ CuZn / N	5194118	2090 13 9	247	1729461
165 ADA M25-32	M25 M32/ CuZn / N	5372189	2088 28 3	248	1729744	168 MS PG16	Pg 16 24/ CuZn / N	5194170	2090 16 3	247	1729462
165 ADA M25-PG11	M25 PG11/ CuZn / N	5391005	2088 32 0	251		168 MS PG21	Pg 21 30/ CuZn / N	5194231	2090 20 1	247	1729463
165 ADA M25-PG13	M25 PG13,5/ CuZn / N	5391012	2088 32 2	251		168 MS PG29	Pg 29 39/ CuZn / N	5194293	2090 29 5	247	1729464
165 ADA M25-PG16	M25 PG16/ CuZn / N	5372356	2088 30 4	251	1729771	168 MS PG36	Pg 36 50/ CuZn / N	5194354	2090 36 8	247	1729465
165 ADA M25-PG21	M25 PG21/ CuZn / N	5391029	2088 32 4	251		168 MS PG42	Pg 42 57/ CuZn / N	5194415	2090 42 2	247	1729466
165 ADA M32-40	M32 M40/ CuZn / N	5372196	2088 28 4	248	1729745	168 MS PG48	Pg 48 64/ CuZn / N	5194477	2090 48 1	247	1729467
165 ADA M32-PG16	M32 PG16/ CuZn / N	5391067	2088 32 8	251		169 MS M12	M12 x 1,5/ CuZn / N	5474135	2091 60 7	246	1711312
165 ADA M32-PG21	M32 PG21/ CuZn / N	5372363	2088 30 5	251	1729774	169 MS M16	M16 x 1,5/ CuZn / N	5931690	2091 61 5	246	1711316
165 ADA M32-PG29	M32 PG29/ CuZn / N	5391074	2088 33 0	251		169 MS M20	M20 x 1,5/ CuZn / N	5931751	2091 62 3	246	1711320
165 ADA M40-50	M40 M50/ CuZn / N	5372202	2088 28 5	248	1729746	169 MS M25	M25 x 1,5/ CuZn / N	5931812	2091 63 1	246	1711325
165 ADA M40-PG21	M40 PG21/ CuZn / N	5391081	2088 33 4	251		169 MS M32	M32 x 1,5/ CuZn / N	5931874	2091 65 8	246	1711332
165 ADA M40-PG29	M40 PG29/ CuZn / N	5372400	2088 30 6	251	1729777	169 MS M40	M40 x 1,5/ CuZn / N	5474197	2091 66 6	246	1711340
165 ADA M40-PG36	M40 PG36/ CuZn / N	5391128	2088 33 6	251		169 MS M50	M50 x 1,5/ CuZn / N	5474791	2091 67 4	246	1711350
165 ADA M50-PG29	M50 PG29/ CuZn / N	5391135	2088 34 0	251		169 MS M63	M63 x 1,5/ CuZn / N	5474852	2091 68 2	246	1711363
165 ADA M50-PG29	M50 PG42/ CuZn / N	5372417	2088 30 7	251	1729779	169 MS PG 7	Pg 7/ CuZn / N	5194538	2091 07 0	246	1729440
165 ADA M63-PG36	M63 PG36/ CuZn / N	5391142	2088 34 4	251		169 MS PG 9	Pg 9/ CuZn / N	5194590	2091 09 7	246	1729441
165 ADA M63-PG42	M63 PG42/ CuZn / N	5391173	2088 34 6	251		169 MS PG11	Pg 11/ CuZn / N	5194651	2091 11 9	246	1729442
165 ADA M63-PG48	M63 PG48/ CuZn / N	5391180	2088 34 8	251		169 MS PG13.5	Pg 13,5/ CuZn / N	5194712	2091 13 5	246	1729443
165 ADA PG11-M16	PG11 M16/ CuZn / N	5372240	2088 29 2	252	1729752	169 MS PG16	Pg 16/ CuZn / N	5194774	2091 15 1	246	1729444
165 ADA PG13-M20	PG13,5 M20/ CuZn / N	5372257	2088 29 3	252	1729753	169 MS PG21	Pg 21/ CuZn / N	5194835	2091 21 6	246	1729445
165 ADA PG16-M20	PG16 M20/ CuZn / N	5372264	2088 29 4	252	1729754	169 MS PG29	Pg 29/ CuZn / N	5194897	2091 29 1	246	1729446
165 ADA PG16-M25	PG16 M25/ CuZn / N	5372271	2088 29 5	252	1729755	169 MS PG36	Pg 36/ CuZn / N	5194958	2091 36 4	246	1729447
165 ADA PG21-M25	PG21 M25/ CuZn / N	5372288	2088 29 6	252	1729756	169 MS PG42	Pg 42/ CuZn / N	5195016	2091 42 9	246	1729448
165 ADA PG21-M32	PG21 M32/ CuZn / N	5372295	2088 29 7	252	1729757	169 MS PG48	Pg 48/ CuZn / N	5195078	2091 48 8	246	1729449
165 ADA PG29-M25	PG29 M25/ CuZn / N	5390916	2088 28 9	252		170 M16	M16 19,9/ FA	5469810	2088 42 8	231	1729217
165 ADA PG29-M40	PG29 M40/ CuZn / N	5372301	2088 29 8	252	1729758	170 M16	M16 19,9/ FA	5469810	2088 42 8	253	1729217
165 ADA PG36-M50	PG36 M50/ CuZn / N	5372318	2088 29 9	252	1729759	170 M20	M20 24/ FA	5469933	2088 43 6	231	1729221
165 ADA PG7-M12	PG7 M12/ CuZn / N	5372226	2088 29 0	252	1729750	170 M20	M20 24/ FA	5469933	2088 43 6	253	1729221
165 ADA PG9-M12	PG9 M16/ CuZn / N	5372233	2088 29 1	252	1729751	170 M25	M25 30/ FA	5469995	2088 44 4	231	1729226
165 MS EZ PG7-9	Pg 7 Pg 9/ CuZn / N	5190813	2088 02 9	249	1729476	170 M25	M25 30/ FA	5469995	2088 44 4	253	1729226
165 MS EZPG11-13	Pg 11 Pg 13,5/ CuZn / N	5190998	2088 09 6	249	1729479	170 M32	M32 38/ FA	5470052	2088 45 2	231	1729233
165 MS EZPG11-16	Pg 11 Pg 16/ CuZn / N	5191056	2088 12 6	249	1729480	170 M32	M32 38/ FA	5470052	2088 45 2	253	1729233

Tyyppi	Mitat/väri/eril.	EAN-C.	Tuoteno	Side	FI-nr.	Tyyppi	Mitat/väri/eril.	EAN-C.	Tuoteno	Side	FI-nr.
170 M50	M5057/ FA	5470595	2088 47 9	253	1729251	342 M10X60 G	M 10 x 6060/ St / G	5257172	3160 60 2	391	
171 M12	M1210/ NBR	5470953	2088 70 3	231	1729214	342 M12X30 G	M 12x3030/ St / G	5257592	3162 30 3	391	
171 M12	M1210/ NBR	5470953	2088 70 3	232	1729214	342 M12X40 G	M 12x4040/ St / G	5257714	3162 40 0	391	
171 M12	M1210/ NBR	5470953	2088 70 3	254	1729214	342 M12X50 G	M 12x5050/ St / G	5257776	3162 50 8	391	
171 M16	M1613/ NBR	5471011	2088 71 1	231	1729218	342 M6X16 G	M6 x 1616/ St / G	5255437	3156 14 1	391	
171 M16	M1613/ NBR	5471011	2088 71 1	232	1729218	342 M6X20 G	M 6 x 2020/ St / G	5255499	3156 20 6	391	
171 M16	M1613/ NBR	5471011	2088 71 1	254	1729218	342 M6X25 G	M6 x 2525/ St / G	5255550	3156 25 7	391	
171 M20	M2018/ NBR	5471257	2088 73 8	231	1729222	342 M6X30 G	M6 x 3030/ St / G	5255611	3156 30 3	391	
171 M20	M2018/ NBR	5471257	2088 73 8	232	1729222	342 M6X35 G	M6 x 3535/ St / G	5255673	3156 35 4	391	
171 M20	M2018/ NBR	5471257	2088 73 8	254	1729222	342 M6X40 G	M6 x 4040/ St / G	5255734	3156 40 0	391	
171 M25	M2522/ NBR	5471318	2088 74 6	231	1729227	342 M8X20 G	M 8 x 2020/ St / G	5256212	3158 20 9	391	
171 M25	M2522/ NBR	5471318	2088 74 6	232	1729227	342 M8X25 G	M8 x 2525/ St / G	5256274	3158 24 1	391	
171 M25	M2522/ NBR	5471318	2088 74 6	254	1729227	342 M8X30 G	M 8x3030/ St / G	5256335	3158 30 6	391	
171 M32	M3229/ NBR	5471370	2088 75 4	231	1729234	342 M8X40 G	M 8x4040/ St / G	5256458	3158 40 3	391	
171 M32	M3229/ NBR	5471370	2088 75 4	232	1729234	342 M8X50 G	M 8x5050/ St / G	5256519	3158 50 0	391	
171 M32	M3229/ NBR	5471370	2088 75 4	254	1729234						
171 M40	M4036/ NBR	5471554	2088 76 2	231	1729242	362 16 BK	162/ St	5291374	3353 16 8	378	
171 M40	M4036/ NBR	5471554	2088 76 2	232	1729242	362 18 BK	182/ St	5291435	3353 18 4	378	
171 M40	M4036/ NBR	5471554	2088 76 2	254	1729242	362 23 BK	232/ St	5291497	3353 23 0	378	
171 M50	M5046/ NBR	5471615	2088 77 0	231	1729252	362 30 BK	302/ St	5291558	3353 30 3	378	
171 M50	M5046/ NBR	5471615	2088 77 0	232	1729252	362 40 BK	402/ St	5291619	3353 40 0	378	
171 M50	M5046/ NBR	5471615	2088 77 0	254	1729252	362 50 BK	502/ St	5291671	3353 50 8	378	
171 M63	M6359/ NBR	5471677	2088 78 9	231	1729265	362 60 BK	602/ St	5291732	3353 60 5	378	
171 M63	M6359/ NBR	5471677	2088 78 9	232	1729265	362 Z 16 G	162/ St / G	5291916	3354 16 4	378	
171 M63	M6359/ NBR	5471677	2088 78 9	254	1729265	362 Z 18 G	182/ St / G	5291978	3354 18 0	378	
171 PG 9	Pg 913/ NBR	5192190	2088 81 9	232		362 Z 23 G	232/ St / G	5292036	3354 23 7	378	
171 PG 9	Pg 913/ NBR	5192190	2088 81 9	254		362 Z 30 G	302/ St / G	5292098	3354 29 6	378	
171 PG11	Pg 1116/ NBR	5192251	2088 82 7	232		362 Z 40 G	402/ St / G	5292159	3354 40 7	378	
171 PG11	Pg 1116/ NBR	5192251	2088 82 7	254		362 Z 50 G	502/ St / G	5292210	3354 50 4	378	
171 PG13.5	Pg 13,518/ NBR	5192312	2088 83 5	232		362 Z 60 G	602/ St / G	5292272	3354 60 1	378	
171 PG13.5	Pg 13,518/ NBR	5192312	2088 83 5	254							
171 PG16	Pg 1620/ NBR	5192374	2088 84 3	232							
171 PG16	Pg 1620/ NBR	5192374	2088 84 3	254		450 M4x95 G	M495/ St / G	5442936	3481 61 1	382	
171 PG21	Pg 2125/ NBR	5192435	2088 85 1	232							
171 PG21	Pg 2125/ NBR	5192435	2088 85 1	254		451 M4x95 G	M495/ St / G	5432852	3481 66 2	382	
171 PG29	Pg 2933/ NBR	5192497	2088 87 8	232							
171 PG29	Pg 2933/ NBR	5192497	2088 87 8	254		452 M4x70 G	M470/ St / G	5432975	3481 77 8	383	
171 PG36	Pg 3643/ NBR	5192558	2088 88 6	232							
171 PG36	Pg 3643/ NBR	5192558	2088 88 6	254		453 M6x100 G	M6100/ St / G	5310631	3482 01 4	383	
171 PG42	Pg 4250/ NBR	5192619	2088 89 4	232							
171 PG42	Pg 4250/ NBR	5192619	2088 89 4	254		454 M6x100 G	M6100/ St / G	5310693	3482 03 0	383	
						455 M5x100 G	M5100/ St / G	5310815	3482 07 3	383	
						455 M5x65 G	M565/ St / G	5310754	3482 05 7	383	
186	25	5864974	3010 10 4	212		456 M5x100 G	M5100/ St / G	5310877	3482 10 3	383	
						457 M4x55 G	M455/ St / G	5310938	3482 13 8	383	
192	1200/ St / DD	6209774	6490 90 5	295		458 M4x100 G	M4100/ St / G	5310990	3482 15 4	383	
197 VA4301	1800/ V2A	6209835	6490 96 4	295	1317463						
255 11 LGR	11 vaaleanharmaa/ PA	5214335	2222 11 6	270		500 12	122/ St	5292999	3360 12 1	378	
255 12.5 LGR	12,5 vaaleanharmaa/ PA	5214397	2222 12 4	270		500 16	162/ St	5293118	3360 16 4	378	
255 14 LGR	14 vaaleanharmaa/ PA	5214458	2222 14 0	270		500 18	182/ St	5293170	3360 18 0	378	
255 16 LGR	16 vaaleanharmaa/ PA	5214519	2222 16 7	270		500 23	232/ St	5293231	3360 23 7	378	
255 17.5 LGR	17,5 vaaleanharmaa/ PA	5214571	2222 17 5	270		500 30	302/ St	5293293	3360 29 6	378	
255 3.2 LGR	3,2 vaaleanharmaa/ PA	5214038	2222 03 5	270		500 40	402/ St	5293354	3360 40 7	378	
255 5.2 LGR	5,2 vaaleanharmaa/ PA	5214090	2222 05 1	270		500 50	502/ St	5293415	3360 50 4	378	
255 6.5 LGR	6,5 vaaleanharmaa/ PA	5214151	2222 07 8	270		500 60	602/ St	5293477	3360 60 1	378	
255 8 LGR	8 vaaleanharmaa/ PA	5214212	2222 08 6	270		500 Z 12	122/ St / G	5293651	3361 12 8	378	
255 9.5 LGR	9,5 vaaleanharmaa/ PA	5214274	2222 09 4	270		500 Z 16	162/ St / G	5293774	3361 16 0	378	
261 3-6 G	3-6 M6 x 12/ St / G	5417132	5305 01 2	299		500 Z 18	182/ St / G	5293835	3361 18 7	378	
325 100 FT	100/9 / St / FT	5422716	5327 10 5	321		500 Z 23	232/ St / G	5293897	3361 23 3	378	
325 130 FT	130/8 / St / FT	5422778	5327 12 1	321		500 Z 30	302/ St / G	5293958	3361 30 6	378	
325 140 FT	140/7 / St / FT	5422839	5327 14 8	321		500 Z 40	402/ St / G	5294078	3361 40 3	378	
325 70 FT	70/10 / St / FT	5422594	5327 07 5	321		500 Z 50	502/ St / G	5294139	3361 50 0	378	
325 80 FT	80/10 / St / FT	5422655	5327 08 3	321		500 Z 60	602/ St / G	5294191	3361 60 8	378	
328 1	5-11 57/ St / ZD	5126799	1408 01 1	321		507	vaaleanharmaa 100/ PS	5225911	2327 10 4	273	FI
328 2	10-19 67/ St / ZD	5126850	1408 04 6	321		508		5228196	2341 10 7	297	
339 1	4-16 100/ St / G	5126973	1408 51 8	320		509		5228073	2341 01 8	297	
339 2	6-34 40/ St / G	5127031	1408 53 4	320		510	vaaleanharmaa / PS	5221173	2236 02 8	297	
342 M10X20 G	M 10 x 2020/ St / G	5256816	3160 20 3	391		511 12	122/ St	5294313	3366 11 1	379	
342 M10X30 G	M 10 x 3030/ St / G	5256939	3160 30 0	391		511 16	162/ St	5294436	3366 16 2	379	
342 M10X40 G	M 10 x 4040/ St / G	5257059	3160 40 8	391		511 18	182/ St	5294498	3366 18 9	379	
342 M10X50 G	M 10 x 5050/ St / G	5257110	3160 50 5	391		511 23	232/ St	5294559	3366 23 5	379	

01 VBS Katalog 2010_Neuer_Stand / fi / 23/11/2011 (LLEXPOT_01071)

Tyyppiluettelo

EAN-numeron rakenne: maatumus 40

valmistajan tunnus 1219 (tuotenumeroille, jotka alkavat numerolla 0 pätee: 1010)

yksilöllinen EAN-C 5647589

Tyyppi	Mitat/väri/eril.	EAN-C.	Tuoteno	Side	Fl-nr.	Tyyppi	Mitat/väri/eril.	EAN-C.	Tuoteno	Side	Fl-nr.
511 30	302/ St	5294610	3366 30 8	379		604 7 G	75000/ St / G	5001034	1003 07 0	285	
511 40	402/ St	5294733	3366 40 5	379		604 8 G	85000/ St / G	5001096	1003 08 9	285	
511 50	502/ St	5294795	3366 50 2	379		604 9 G	95000/ St / G	5001157	1003 09 7	285	
511 60	602/ St	5294856	3366 59 6	379							
511 Z 12	122/ St / G	5294917	3367 12 6	379		605 10 G	10 4,5 x 6/ St / G	5016458	1018 10 8	289	
511 Z 16	162/ St / G	5295037	3367 16 9	379		605 11 G	11 4,5 x 6/ St / G	5016519	1018 11 6	289	
511 Z 18	182/ St / G	5295099	3367 18 5	379		605 12 G	12 4,5 x 6/ St / G	5016571	1018 12 4	289	
511 Z 23	232/ St / G	5295150	3367 23 1	379		605 13 G	13 4,5 x 6/ St / G	5016632	1018 13 2	289	
511 Z 30	302/ St / G	5295211	3367 30 4	379		605 14 G	14 4,5 x 6/ St / G	5016694	1018 14 0	289	
511 Z 40	402/ St / G	5295334	3367 40 1	379		605 15 G	15 4,5 x 6/ St / G	5016755	1018 15 9	289	
511 Z 50	502/ St / G	5295396	3367 50 9	379		605 16 ALU	16 4,5 x 6/ Al	5449539	1017 79 9	290	1317616
						605 16 G	16 4,5 x 6/ St / G	5016816	1018 16 7	289	
						605 17 G	17 4,5 x 6/ St / G	5016878	1018 17 5	289	
550 6X180 SW	6 x 180 45/ PA	5454991	2330 05 9	294		605 18 G	18 4,5 x 6/ St / G	5016939	1018 18 3	289	
550 6X290 SW	6 x 290 78/ PA	5455059	2330 07 5	294		605 19 G	19 4,5 x 6/ St / G	5016991	1018 19 1	289	
550 6X360 SW	6 x 360 100/ PA	5455110	2330 09 1	294		605 20 ALU	20 4,5 x 6/ Al	5449652	1017 83 7	290	1317620
550 9X180 SW	9 x 180 40/ PA	5455417	2330 22 9	294		605 20 G	20 4,5 x 6/ St / G	5017059	1018 20 5	289	
550 9X265 SW	9 x 260 65/ PA	5455479	2330 24 5	294		605 21 G	21 4,5 x 6/ St / G	5017110	1018 21 3	289	
550 9X360 SW	9 x 360 93/ PA	5455592	2330 29 6	294		605 23 G	23 4,5 x 6/ St / G	5017172	1018 22 1	289	
550 9X510 SW	9 x 510 140/ PA	5455653	2330 32 6	294		605 25 ALU	25 4,5 x 6/ Al	5449836	1017 86 1	290	1317625
550 9X760 SW	9 x 760 220/ PA	5455714	2330 34 2	294		605 25 G	25 4,5 x 6/ St / G	5017233	1018 25 6	289	
						605 26 G	26 4,5 x 6/ St / G	5017295	1018 26 4	289	
555 2.4x75 WS	2,4 x 75 15/ PA	5226994	2332 02 7	294		605 28 G	28 4,5 x 6/ St / G	5017356	1018 28 0	289	
555 2.5x100 WS	2,5 x 100 18/ PA	5819851	2332 62 0	294		605 30 G	30 4,5 x 6/ St / G	5017417	1018 30 2	289	
555 2.5x100 WS	2,5 x 100 18/ PA	5227052	2332 05 1	294	1317452	605 32 ALU	32 4,5 x 6/ Al	5590170	1017 92 6	290	1317632
555 2.5x165 WS	2,5 x 165 40/ PA	5227113	2332 09 4	294		605 32 G	32 4,5 x 6/ St / G	5017479	1018 33 7	289	
555 2.5x200 WS	2,5 x 200 50/ PA	5227175	2332 10 8	294		605 35 G	35 5,5 x 7/ St / G	5017530	1018 35 3	289	
555 3.6x150 SW	3,6 x 140 35/ PA	5819912	2332 65 5	294		605 37 G	37 5,5 x 7/ St / G	5017592	1018 36 1	289	
555 3.6x150 WS	3,6 x 140 35/ PA	5227236	2332 17 5	294	1317453	605 40 ALU	40 5,5 x 7/ Al	5450016	1017 95 0	290	1317640
555 3.6x200 SW	3,6 x 200 50/ PA	5819974	2332 66 3	294		605 40 G	40 5,5 x 7/ St / G	5017653	1018 39 6	289	
555 3.6x200 WS	3,6 x 200 50/ PA	5227298	2332 18 3	294		605 43 G	43 5,5 x 7/ St / G	5017714	1018 43 4	289	
555 3.6x290 WS	3,6 x 290 76/ PA	5227359	2332 21 3	294		605 47 G	47 5,5 x 7/ St / G	5017776	1018 47 7	289	
555 4.8x200 SW	4,8 x 200 47/ PA	5820031	2332 69 8	294		605 50 ALU	50 5,5 x 7/ Al	5589938	1017 98 0	290	
555 4.8x200 WS	4,8 x 200 47/ PA	5227410	2332 33 7	294	1317454	605 50 G	50 5,5 x 7/ St / G	5568339	1018 50 7	289	
555 4.8x310 SW	4,8 x 300 76/ PA	5820093	2332 70 1	294		605 55 G	55 5,5 x 7/ St / G	5017837	1018 55 8	289	
555 4.8x310 WS	4,8 x 300 76/ PA	5227472	2332 36 1	294	1317455	605 60 G	60 5,5 x 7/ St / G	5017899	1018 60 4	289	
555 4.8x370 SW	4,8 x 370 102/ PA	5820154	2332 72 8	294		605 63 ALU	63 5,5 x 7/ Al	5590057	1017 99 7	290	
555 4.8x370 WS	4,8 x 370 102/ PA	5227533	2332 38 8	294	1317456	605 63 G	63 5,5 x 7/ St / G	5568513	1018 63 9	289	
555 7.6x200 WS	7,6 x 200 50/ PA	5227595	2332 50 7	294		605 7 G	7 4,5 x 6/ St / G	5016274	1018 07 8	289	
555 7.6x300 WS	7,6 x 300 76/ PA	5227656	2332 55 8	294		605 8 G	8 4,5 x 6/ St / G	5016335	1018 08 6	289	
555 7.6x380 SW	7,6 x 380 102/ PA	5820215	2332 75 2	294		605 9 G	9 4,5 x 6/ St / G	5016397	1018 09 4	289	
555 7.6x380 WS	7,6 x 380 102/ PA	5227717	2332 57 4	294	1317457						
						689	vaaleanharmaa/ PA	5159377	2017 34 2	165	1627171
						689	vaaleanharmaa/ PA	5159377	2017 34 2	166	1627171
574 03 30 BA	17 x 1,0300/ V2A	6209538	6490 10 7	295							
574 03 45 BA	17 x 1,0450/ V2A	6209590	6490 12 3	295		700 6	/ MF	5159254	2017 29 6	183	
574 03 BA	17 x 1,02250/ V2A	6209415	6490 03 4	295							
						716 3X50 BK	503/ St	5289272	3347 05 2	379	
						716 3X60 BK	603/ St	5289333	3347 06 0	379	
						716 3X70 BK	703/ St	5289395	3347 07 9	379	
574 05 55 GNBG	16,5 x 1,2550/ V2A	6209651	6490 15 8	295							
574 05 65 GNBG	16,5 x 1,2650/ V2A	6209712	6490 17 4	295							
						731 W 12 CU	8-12 M5 x 12/ St / Cu	5118275	1366 62 9	281	
574 05 GNBG	16,5 x 1,23500/ V2A	6209477	6490 05 0	295		731 W 12 G	8-12 M5 x 12/ St / G	5117919	1366 12 2	281	
574 G STGR	17 x 1,01350/ St / G	6209354	6490 01 8	295	1317460	731 W 16 CU	12-16 M5 x 14/ St / Cu	5118336	1366 66 1	281	
						731 W 16 G	12-16 M5 x 12/ St / G	5117971	1366 16 5	281	
						731 W 20 G	16-20 M5 x 14/ St / G	5118039	1366 20 3	281	
						731 W 25 G	20-25 M5 x 14/ St / G	5118091	1366 25 4	281	
575	/ St	6209897	6498 01 9	295		731 W 30 G	25-30 M5 x 14/ St / G	5118152	1366 30 0	281	
						731 W 35 G	30-35 M5 x 18/ St / G	5118213	1366 35 1	281	
576	/ St	6209958	6498 02 7	296	6401548						
						732 10 GTP	9-10 -/ St / GTP	5114611	1360 10 8	278	
						732 12 GTP	10,5-12 M12/ St / GTP	5114673	1360 12 4	278	
604 10 G	104800/ St / G	5001218	1003 10 0	285		732 14 GTP	12,5-14 PG7/ St / GTP	5114734	1360 14 0	278	
604 11 G	114800/ St / G	5001270	1003 11 9	285		732 15 GTP	13,5-15 PG9/ St / GTP	5114796	1360 15 9	278	
604 12 G	125000/ St / G	5001331	1003 12 7	285		732 16 GTP	14,5-16 M16/ St / GTP	5114857	1360 16 7	278	
604 13 G	135000/ St / G	5001393	1003 13 5	285		732 18 GTP	16,5-18 PG11/ St / GTP	5114918	1360 18 3	278	
604 16 G	163900/ St / G	5001454	1003 17 8	285		732 20 GTP	18,5-20 M20/ St / GTP	5114970	1360 20 5	278	
604 19 G	191800/ St / G	5001515	1003 19 4	285		732 22 GTP	20-22 PG13,5/ St / GTP	5115038	1360 22 1	278	
604 20 G	201800/ St / G	5001577	1003 20 8	285		732 24 GTP	22-24 PG16/ St / GTP	5115090	1360 24 8	278	
604 21 G	213000/ St / G	5001638	1003 21 6	285		732 26 GTP	24-26 M25/ St / GTP	5115151	1360 26 4	278	
604 23 G	232400/ St / G	5001690	1003 23 2	285		732 28 GTP	26-28 PG21/ St / GTP	5115212	1360 28 0	278	
604 25 G	251000/ St / G	5566892	1003 25 9	285		732 30 GTP	28-30 PG21/ St / GTP	5115274	1360 30 2	278	
604 28 G	281000/ St / G	5001751	1003 28 3	285		732 33 GTP	31-33 M32/ St / GTP	5115335	1360 33 7	278	
604 2X16	2 x 161000/ St / G	5002833	1004 16 6	288		732 35 GTP	33-35 -/ St / GTP	5115397	1360 35 3	278	
604 2X19	2 x 191000/ St / G	5002895	1004 19 0	288		732 38 GTP	36-38 PG29/ St / GTP	5115458	1360 38 8	278	
604 2X21	2 x 211000/ St / G	5003014	1004 21 2	288		732 40 GTP	38-40 M40/ St / GTP	5115519	1360 39 6	278	
604 2X28	2 x 286000/ St / G	5003137	1004 29 8	288		732 42 GTP	40-42 M40/ St / GTP	5115571	1360 42 6	278	
604 3 G	312000/ St / G	5000792	1003 03 8	285		732 45 GTP	43-45 -/ St / GTP	5115632	1360 45 0	278	
604 32 G	328000/ St / G	5566953	1003 32 1	285		732 48 GTP	46-48 PG36/ St / GTP	5115694	1360 48 5	278	
604 35 G	358000/ St / G	5001812	1003 35 6	285		732 50 GTP	48-50 M50/ St / GTP	5115755	1360 50 7	278	
604 37 G	378000/ St / G	5001874	1003 37 2	285		732 6 GTP	5-6 -/ St / GTP	5114499	1360 05 1	278	
604 4 G	412000/ St / G	5000853	1003 04 6	285		732 60 GTP	58-60 PG48/ St / GTP	5115878	1360 60 4	278	
604 40 G	401200/ St / G	5001935	1003 40 2	285		732 63 GTP	61-63 M63/ St / GTP	5569114	1360 63 9	278	
604 47 G	475000/ St / G	5002055	1003 46 1	285		732 8 GTP	7-8 -/ St / GTP	5114550	1360 08 6	278	
604 5 G	55000/ St / G	5000914	1003 05 4	285							
604 6 G	65000/ St / G	5000976	1003 06 2	285		733 13 FT	11-13 6,5 x 10/ St / FT	5029755	1361 09 1	280	

Tyyppi	Mitat/väri/eril.	EAN-C.	Tuotenro	Side	Fl-nr.	Tyyppi	Mitat/väri/eril.	EAN-C.	Tuotenro	Side	Fl-nr.
733 13 G	11-13 6,5 x 10/ St / G	5115939	1361 13 9	279	1339458	903 40 G	4048/ St / G	5246015	3100 40 5	380	
733 16 ALU	14-16 6,5 x 10/ Al	5450252	1362 52 6	280	1317516	903 55 G	5563/ St / G	5246077	3100 55 3	380	
733 16 FT	14-16 6,5 x 10/ St / FT	5029762	1361 09 4	280		903 RB 15	1521/ St	5851059	3105 01 6	380	
733 16 G	14-16 6,5 x 10/ St / G	5115991	1361 16 3	279	1339459	903 RB 18	1824/ St	5851110	3105 02 4	380	
733 16 VA	14-16 6,5 x 10/ V2A	5116714	1362 01 1	279	1339468	903 RB 22	2230/ St	5851172	3105 03 2	380	
733 19 ALU	17-19 6,5 x 10/ Al	5450313	1362 53 4	280	1317519						
733 19 FT	17-19 6,5 x 10/ St / FT	5029809	1361 09 7	280		904 A 15 FS	1522/ St / G	5247753	3116 15 8	380	
733 19 G	17-19 6,5 x 10/ St / G	5116059	1361 19 8	279	1339460	904 B 15 FS	1526/ St / G	5248170	3117 15 4	380	
733 19 VA	17-19 6,5 x 10/ V2A	5116776	1362 03 8	279	1339469	904 B 18 FS	1829/ St / G	5248231	3117 18 9	380	
733 21 ALU	19-21 6,5 x 10/ Al	5450375	1362 54 2	280	1317521						
733 21 FT	19-21 6,5 x 10/ St / FT	5029816	1361 10 0	280		910 DF 6x35	635/ PA	5448099	2347 40 7	381	
733 21 G	19-21 6,5 x 10/ St / G	5116110	1361 20 1	279	1339461	910 GD 6x35	635/ PA	5828198	2347 22 9	382	
733 21 VA	19-21 6,5 x 10/ V2A	5116837	1362 04 6	279	1339470	910 GD 8x50	850/ PA	5828259	2347 26 1	382	
733 23 FT	21-23 6,5 x 10/ St / FT	5029823	1361 10 3	280		910 GKDM 12x30	1230/ Zn	5418191	3483 21 4	382	
733 23 G	21-23 6,5 x 10/ St / G	5116172	1361 23 6	279	1339462	910 GKSM 6x25	7,526,4/ Zn	5418207	3483 23 9	382	
733 23 VA	21-23 6,5 x 10/ V2A	5116899	1362 05 4	279	1339471	910 MZ 10x60	1060/ PA	5084990	2347 55 5	381	
733 29 ALU	24-29 6,5 x 10/ Al	5450498	1362 56 9	280	1317529	910 MZ 12x70	1270/ PA	5625667	2347 57 0	381	
733 29 FT	24-29 6,5 x 10/ St / FT	5029861	1361 10 6	280		910 MZ 5x30	530/ PA	5625650	2347 52 3	381	
733 29 G	24-29 6,5 x 10/ St / G	5116233	1361 29 5	279	1339463	910 MZ 6x35	635/ PA	5228738	2347 53 9	381	
733 29 VA	24-29 6,5 x 10/ V2A	5116950	1362 06 2	279	1339472	910 MZ 8x50	850/ PA	5084969	2347 54 7	381	
733 38 ALU	30-38 6,5 x 10/ Al	5450559	1362 57 7	280	1317538	910 N 10x50 GRW	1050/ PA	5229155	2349 10 8	381	1339963
733 38 FT	30-38 6,5 x 10/ St / FT	5029878	1361 10 9	280		910 N 12x60 GRW	1260/ PA	5229216	2349 12 4	381	1339964
733 38 G	30-38 6,5 x 10/ St / G	5116295	1361 38 4	279	1339464	910 N 5x25 GRW	525/ PA	5228851	2349 04 3	381	1339960
733 38 VA	30-38 6,5 x 10/ V2A	5117018	1362 07 0	279	1339473	910 N 6x30 GRW	630/ PA	5228912	2349 05 1	381	1339961
733 48 ALU	39-48 6,5 x 10/ Al	5450610	1362 58 5	280	1317548	910 N 6x60 GRW	660/ PA	5228974	2349 07 8	381	
733 48 FT	39-48 6,5 x 10/ St / FT	5029885	1361 11 2	280		910 N 8x40 GRW	840/ PA	5229032	2349 08 6	381	1339962
733 48 G	39-48 6,5 x 10/ St / G	5116356	1361 48 1	279	1339465	910 SD 5X35	535/ PA	5229452	2351 02 1	381	1339970
733 48 VA	39-48 6,5 x 10/ V2A	5117070	1362 08 9	279	1339474	910 SD 6X35	635/ PA	5669197	2351 05 6	265	
733 54 ALU	48-54 6,5 x 10/ Al	5450672	1362 59 3	280	1317554	910 SD 6X40	640/ PA	5229513	2351 06 4	265	1339971
733 54 FT	48-54 6,5 x 10/ St / FT	5615651	1361 11 7	280		910 SD 6X40	640/ PA	5229513	2351 06 4	381	1339971
733 54 G	48-54 6,5 x 14/ St / G	5116417	1361 51 1	279	1339466	910 SD 6X40	640/ PA	5229513	2351 06 4	381	1339972
733 54 VA	48-54 6,5 x 14/ V2A	5117131	1362 09 7	279	1339475	910 SD 8X55	855/ PA	5229575	2351 09 9	381	1339980
733 61 FT	53-61 6,5 x 10/ St / FT	5254348	1361 11 5	280		910 SDM M6	M66/ PA	5874454	2350 80 7	381	1339980
733 61 G	53-61 6,5 x 14/ St / G	5116479	1361 61 9	279	1339467	910 SD K 6x40	640/ PA	5229636	2351 21 8	381	
733 61 VA	53-61 6,5 x 14/ V2A	5117193	1362 10 0	279	1339476	910 STK 6x30	35/ PA	5708971	2351 60 9	261	
733 63 ALU	63-63 8 x 18/ Al	5590293	1362 61 5	280		910 STP 6x30	630/ PA	5242352	2351 41 2	262	1317470
733 63 FT	63-63 6,5 x 10/ St / FT	5254386	1361 11 8	280							
733 63 G	63-63 8 x 18/ St / G	5116530	1361 63 5	279		915 3.9x100 G	3,9100/ St / G	5304630	3450 10 4	387	1339522
733 63 VA	63-63 8 x 18/ V2A	5117254	1362 12 7	279		915 3.9x50 G	3,950/ St / G	5304333	3450 05 8	387	1339517
						915 3.9x60 G	3,960/ St / G	5304395	3450 06 6	387	1339518
						915 3.9x70 G	3,970/ St / G	5304456	3450 07 4	387	1339519
						915 3.9x80 G	3,980/ St / G	5304517	3450 08 2	387	1339520
						915 3.9x90 G	3,990/ St / G	5304579	3450 09 0	387	1339521
						915 4.3x120 G	4,3120/ St / G	5304692	3450 12 0	387	1339523
822 10 FT	10/ St / FT	5013693	1014 01 3	287							
822 12 FT	12 M12/ St / FT	5013754	1014 02 1	287		915 RBS M4	12/ St	5851417	3031 50 0	380	
822 14 FT	14/ St / FT	5013815	1014 04 8	287		915 S M6	13514/ St	5241690	3031 01 2	380	
822 16 FT	15,2 M16/ St / FT	5013877	1014 09 9	287	1317160						
822 18 FT	18,6 PG11/ St / FT	5013938	1014 11 0	287							
822 20 FT	20 M20/ St / FT	5013990	1014 13 7	287	1317161						
822 22,5 FT	22,5 PG16/ St / FT	5014058	1014 16 1	287							
822 25 FT	25 M25/ St / FT	5567011	1014 50 1	287	1317162						
822 28,3 FT	28,3 PG21/ St / FT	5014119	1014 21 8	287		917 3.9x70 G	3,970/ St / G	5304753	3452 01 8	387	1339524
822 32 FT	32 M32/ St / FT	5567073	1014 52 8	287	1317163						
822 37 FT	37 PG29/ St / FT	5014171	1014 29 3	287							
822 40 FT	40 M40/ St / FT	5567134	1014 53 6	287		944 CLS 1000mm	10000/ St / G	5647430	5300 28 2	301	
822 47 FT	47 PG36/ St / FT	5014232	1014 36 6	287		944 CLS 1000mm	1000/ St / G	5647409	5300 27 0	301	
822 50 FT	50 M50/ St / FT	5567493	1014 54 4	287		944 CLS 3000mm	3000/ St / G	5647416	5300 27 4	301	
822 6 FT	6/ St / FT	5013631	1014 00 5	287		944 CLS 5000mm	5000/ St / G	5647423	5300 27 8	301	
822 63 FT	63 M63/ St / FT	5567554	1014 55 2	287		944 RZS 2 G	2,2-5 26,6/ Zn	5464228	5300 01 5	301	
						944 RZS 3 G	2,5-3,5 36,4/ Zn	5464266	5300 01 9	301	
823 16 FT	16 6,5 x 10/ St / FT	5015130	1015 09 5	290		944 SLS 1000mm	1000/ St / G	5647331	5300 22 0	301	
823 18,3 FT	18,6 6,5 x 10/ St / FT	5015192	1015 11 7	290		944 SLS 3000mm	3000/ St / G	5647348	5300 22 4	301	
823 20 FT	20 6,5 x 10/ St / FT	5015253	1015 13 3	290		944 SLS 5000mm	5000/ St / G	5647355	5300 22 8	301	
823 22,5 FT	22,5 6,5 x 10/ St / FT	5015314	1015 16 8	290		944 TLS 230mm	230/ St / G	5647287	5300 21 0	301	
823 25 FT	25 6,5 x 10/ St / FT	5567615	1015 49 4	290		944 TLS 300mm	300/ St / G	5647317	5300 21 2	301	
823 28,3 FT	28,3 6,5 x 10/ St / FT	5015376	1015 21 4	290		944 TLS 460mm	460/ St / G	5647324	5300 21 4	301	
823 32 FT	32 6,5 x 10/ St / FT	5567738	1015 49 6	290		944 ZLS 1000mm	10000/ St / G	5647393	5300 25 2	301	
823 37 FT	37 6,5 x 10/ St / FT	5015437	1015 30 3	290		944 ZLS 1000mm	1000/ St / G	5647362	5300 24 0	301	
823 40 FT	40 6,5 x 10/ St / FT	5567790	1015 49 8	290		944 ZLS 3000mm	3000/ St / G	5647379	5300 24 4	301	
823 47 FT	47 6,5 x 10/ St / FT	5015499	1015 36 2	290		944 ZLS 5000mm	5000/ St / G	5647386	5300 24 8	301	
823 50 FT	50 6,5 x 10/ St / FT	5567851	1015 50 0	290							
823 54 FT	54 6,5 x 10/ St / FT	5015550	1015 42 7	290		945 M10 G	M1014/ St / G	5413592	5300 05 3	298	
823 59,3 FT	59,3 6,5 x 10/ St / FT	5015611	1015 48 6	290		945 M12 G	M1216/ St / G	5413653	5300 06 1	298	
823 63 FT	63 6,5 x 10/ St / FT	5567912	1015 50 8	290		945 M16 G	M1622/ St / G	5413714	5300 08 8	298	
						945 M6 G	M69/ St / G	5413530	5300 03 7	298	
865 M10x34	M10/ CuZn	5311294	3483 09 6	382		946 10 FT	1043/ St / FT	5414315	5301 10 6	298	
865 M6x24	M68/ CuZn	5311171	3483 06 1	382		946 3 G	321,5/ St / G	5413950	5301 03 3	298	
865 M8x30	M811/ CuZn	5311232	3483 08 8	382		946 4 G	426,5/ St / G	5414018	5301 04 1	298	
867 M5X125 G	M5125/ St / G	5309253	3470 14 8	387	1339504	946 5 G	528,5/ St / G	5413899	5301 00 9	298	
867 M6X 95 G	M695/ St / G	5309314	3470 21 0	387	1339505	946 6 G	630/ St / G	5414070	5301 06 8	298	
867 M6X125 G	M6125/ St / G	5309376	3470 23 7	387	1339506	946 8 G	835/ St / G	5414193	5301 08 4	298	
869 M8X40 G	M870/ St / G	5309550	3472 08 6	387		947 10 F	1042/ TG / F	5414797	5302 10 2	299	
903 15 G	1523/ St / G	5245773	3100 15 4	380		947 3 F	320/ TG / F	5414551	5302 02 1	299	
903 18 G	1826/ St / G	5245834	3100 18 9	380		947 5 F	524/ TG / F	5414612	5302 05 6	299	
903 25 G	2533/ St / G	5245896	3100 25 1	380		947 6 F	628/ TG / F	5414674	5302 06 4	299	
903 30 G	3038/ St / G	5245957	3100 30 8	380		947 8 F	834/ TG / F	5414735	5302 08 0	299	

01 VBS Katalog 2010_Neuer_Stand / fi / 23/11/2011 (LLExpert_01071)

Tyyppiluettelo

EAN-numeron rakenne: maatumnus 40

valmistajan tunnus 1219 (tuotenumeroille, jotka alkavat numerolla 0 pätee: 1010)

yksilöllinen EAN-C 5647589

Tyyppi	Mitat/väri/eril.	EAN-C.	Tuoteno	Side	FI-nr.	Tyyppi	Mitat/väri/eril.	EAN-C.	Tuoteno	Side	FI-nr.
948 TG6	M66/ St / G	5513315	3453 82 0	387		1101 3.4x80	803,4/ St	5287957	3341 80 1	379	
						1101 3.4x90	903,4/ St	5288015	3341 90 9	379	
						1101 3x40	403/ St	5287537	3341 04 6	379	
957 10 G	54,4/ St / G	5415336	5303 26 5	298		1101 3x50	503/ St	5287599	3341 05 4	379	
957 2 G	2,35/ St / G	5464273	5303 20 2	298		1101 3x60	603/ St	5287650	3341 06 2	379	
957 3 G	5,29/ St / G	5414971	5303 20 6	298		1101 3x70	703/ St	5287711	3341 07 0	379	
957 4 G	9,41/ St / G	5415039	5303 21 4	298		1101 Z 40 G	403/ St / G	5288138	3342 04 2	379	
957 5 G	14,7/ St / G	5415091	5303 22 2	298		1101 Z 50 G	503/ St / G	5288190	3342 05 0	379	
957 6 G	21,1/ St / G	5415152	5303 23 0	298		1101 Z 60 G	603/ St / G	5288251	3342 06 9	379	
957 8 G	34,8/ St / G	5415275	5303 25 7	298		1101 Z 70 G	703/ St / G	5288312	3342 07 7	379	
						1101 Z3.4x50 G	503,4/ St / G	5288374	3342 50 6	379	
						1101 Z3.4x60 G	603,4/ St / G	5288435	3342 60 3	379	
						1101 Z3.4x70 G	703,4/ St / G	5288497	3342 70 0	379	
						1101 Z3.4x80 G	803,4/ St / G	5288558	3342 80 8	379	
964 M10 G	M10 10,5/ St / G	5868330	3403 16 5	392							
964 M4 G	M44,3/ St / G	5867913	3403 02 5	392							
964 M5 G	M55,3/ St / G	5867975	3403 04 1	392							
964 M6 G	M66,4/ St / G	5868095	3403 08 4	392							
964 M6 G	M66,4/ St / G	5868156	3403 09 2	392		1268 KD FT	/ St / FT	6192373	6350 10 0	323	
964 M6 G	M66,4/ St / G	5868033	3403 07 6	392		1268 KP FT	/ St / FT	6192311	6350 05 4	323	
964 M8 G	M88,4/ St / G	5868217	3403 12 2	392							
964 M8 G	M88,4/ St / G	5868279	3403 13 0	392							
						1268 L 150 FS	/ St / FS	5038238	1104 24 1	321	
						1268 L 150 FS	/ St / FS	5038238	1104 24 1	332	
965 M6X20 G	M6 6/ Zn / G	5303558	3415 03 1	386							
965 M6X25 G	M6 6/ Zn / G	5303619	3415 06 6	386		1268 L 1M FS	/ St / FS	5694458	1104 49 7	321	
965 M6X30 G	M6 6/ Zn / G	5303671	3415 08 2	386		1268 L 1M FS	/ St / FS	5694458	1104 49 7	332	
965 M6X40 G	M6 6/ Zn / G	5303732	3415 10 4	386		1268 L 1M VA	/ V2A	5627074	1104 49 8	333	
965 M6X50 G	M6 6/ Zn / G	5303794	3415 12 0	386							
965 M8X20 G	M8 8/ Zn / G	5303855	3415 14 7	386		1268 L 200 FS	/ St / FS	5038290	1104 26 8	321	
965 M8X30 G	M8 8/ Zn / G	5303916	3415 16 3	386		1268 L 200 FS	/ St / FS	5038290	1104 26 8	332	
						1268 L 2M FS	/ St / FS	5038771	1104 50 0	321	1462439
966 M10 G	M10 10,5/ St / G	5300137	3402 09 6	324		1268 L 2M FS	/ St / FS	5038771	1104 50 0	332	1462439
966 M10 G	M10 10,5/ St / G	5300137	3402 09 6	392		1268 L 2M VA	/ V2A	5627081	1104 50 1	333	
966 M10 VA	M10 10,5/ V2A	5300618	3402 32 0	392							
966 M12 G	M12 13/ St / G	5300199	3402 12 6	392		1268 L 300 FS	/ St / FS	5038351	1104 28 4	321	
966 M12 VA	M12 13/ V2A	5300670	3402 33 9	392		1268 L 300 FS	/ St / FS	5038351	1104 28 4	332	
966 M4 G	M44,3/ St / G	5299899	3402 04 5	392		1268 L 400 FS	/ St / FS	5836353	1104 29 2	321	
966 M6 G	M66,4/ St / G	5300014	3402 06 1	324		1268 L 400 FS	/ St / FS	5836353	1104 29 2	332	
966 M6 G	M66,4/ St / G	5300014	3402 06 1	392		1268 L 500 FS	/ St / FS	5038412	1104 30 6	321	
966 M6 VA	M66,4/ V2A	5300496	3402 30 4	392		1268 L 500 FS	/ St / FS	5038412	1104 30 6	332	
966 M8 G	M88,4/ St / G	5300076	3402 08 8	324		1268 L 600 FS	/ St / FS	5036678	1104 31 0	321	
966 M8 G	M88,4/ St / G	5300076	3402 08 8	392		1268 L 600 FS	/ St / FS	5036678	1104 31 0	332	
966 M8 VA	M88,4/ V2A	5300557	3402 31 2	392		1268 L 700 FS	/ St / FS	5036739	1104 31 5	321	
						1268 L 700 FS	/ St / FS	5036739	1104 31 5	332	
967 M10 G	M10 11/ St / G	5300434	3402 22 3	324		1268 L 800 FS	/ St / FS	5036791	1104 32 0	321	
967 M10 G	M10 11/ St / G	5300434	3402 22 3	392		1268 L 800 FS	/ St / FS	5036791	1104 32 0	332	
967 M6 G	M66,5/ St / G	5300311	3402 20 7	324	1464238	1268 L 900 FS	/ St / FS	5036852	1104 32 5	321	
967 M6 G	M66,5/ St / G	5300311	3402 20 7	392	1464238	1268 L 900 FS	/ St / FS	5036852	1104 32 5	332	
967 M8 G	M88,5/ St / G	5300373	3402 21 5	324		1268 SK OR	oranssi 800/ PE	5668114	1124 50 2	322	
967 M8 G	M88,5/ St / G	5300373	3402 21 5	392		1268 SK OR	oranssi 800/ PE	5668114	1124 50 2	333	
						1268 SL 150 FS	/ St / FS	5038474	1104 34 9	322	
						1268 SL 150 FS	/ St / FS	5038474	1104 34 9	333	
985 M6 25	84,3/ St / G	5250395	3133 02 8	386							
985 M6 35	84,3/ St / G	5250456	3133 03 6	386		1268 SL 1M FS	/ St / FS	5052692	1104 44 5	322	
985 M8 35	105,2/ St / G	5250579	3133 23 0	386		1268 SL 1M FS	/ St / FS	5052692	1104 44 5	333	
1015 10 G	102000/ St / G	5007753	1009 07 9	286		1268 SL 200 FS	/ St / FS	5038535	1104 35 7	322	
1015 11 G	111800/ St / G	5007814	1009 08 7	286		1268 SL 200 FS	/ St / FS	5038535	1104 35 7	333	
1015 12 G	121000/ St / G	5007876	1009 10 9	286							
1015 13 G	131800/ St / G	5007937	1009 11 7	286		1268 SL 2M FS	/ St / FS	5038719	1104 45 4	322	
1015 14 G	141200/ St / G	5007999	1009 16 8	286		1268 SL 2M FS	/ St / FS	5038719	1104 45 4	333	
1015 15 G	151200/ St / G	5008057	1009 18 4	286							
1015 16 G	161200/ St / G	5008118	1009 19 2	286		1268 SL 300 FS	/ St / FS	5038597	1104 37 3	322	
1015 17 G	171200/ St / G	5008170	1009 20 6	286		1268 SL 300 FS	/ St / FS	5038597	1104 37 3	333	
1015 18 G	181200/ St / G	5008231	1009 21 4	286		1268 SL 400 FS	/ St / FS	5052814	1104 39 1	322	
1015 20 G	201200/ St / G	5008354	1009 23 0	286		1268 SL 400 FS	/ St / FS	5052814	1104 39 1	333	
1015 25 G	251000/ St / G	5009078	1009 42 7	286		1268 SL 500 FS	/ St / FS	5038658	1104 40 3	322	
1015 28 G	281000/ St / G	5008712	1009 36 2	286		1268 SL 500 FS	/ St / FS	5038658	1104 40 3	333	
1015 5 G	53000/ St / G	5007456	1009 02 8	286		1268 SL 600 FS	/ St / FS	5486190	1104 41 1	322	
1015 6 G	62400/ St / G	5007517	1009 03 6	286		1268 SL 600 FS	/ St / FS	5486190	1104 41 1	333	
1015 7 G	72000/ St / G	5007579	1009 04 4	286		1268 SL 800 FS	/ St / FS	5051732	1104 42 7	322	
1015 8 G	82000/ St / G	5007630	1009 05 2	286		1268 SL 800 FS	/ St / FS	5051732	1104 42 7	333	
1015 9 G	92000/ St / G	5007692	1009 06 0	286		1268 SL 900 FS	/ St / FS	5052630	1104 43 5	322	
						1268 SL 900 FS	/ St / FS	5052630	1104 43 5	333	
1020 11-16 G	M4 x 131200/ St / G	5125891	1404 16 4	298							
1020 14-18 G	M4 x 131000/ St / G	5125952	1404 18 0	298							
1020 18-28 G	M4 x 13600/ St / G	5126010	1404 28 8	298		1268 SP 3M FT	3000/ St / FT	6192557	6350 20 8	323	
1060 26-45 FT	26-45 M5 x 30/ St / FT	5105978	1310 61 5	284		1268 W 90 G	/ St / G	6192496	6350 15 1	323	1464222
1060 45-68 FT	45-68 M6 x 35/ St / FT	5106036	1310 65 8	284							
1101 3.4x100	1003,4/ St	5288077	3341 99 2	379							
1101 3.4x50	503,4/ St	5287773	3341 49 6	379		1594 22 G	22 6/ St / G	5106159	1310 92 5	288	
1101 3.4x60	603,4/ St	5287834	3341 60 7	379							
1101 3.4x70	703,4/ St	5287896	3341 70 4	379		1973 20-40 LGR	20-40 89/ PA	5640035	2148 86 2	261	1317407

01 VBS Katalog 2010_Neuer_Stand / fi / 23/11/2011 (LLEExport_01071)

Tyyppi	Mitat/väri/eril.	EAN-C.	Tuotenro	Side	Fl-nr.	Tyyppi	Mitat/väri/eril.	EAN-C.	Tuotenro	Side	Fl-nr.
1973 3-13 LGR	3-13 52/ PA	5947899	2148 80 3	261	1317403	2014 40 LGR	14 2,5 x 40/ PP	5218951	2228 11 4	272	
1973 8-28 LGR	8-28 70/ PA	5877691	2148 84 6	261	1317405	2014 40 RW	14 2,5 x 40/ PP	5216490	2226 11 1	273	
						2014 50 LGR	14 2,5 x 50/ PP	5219019	2228 12 2	272	
1974 16-23	16-23 6/ PA	5742999	2197 80 4	261							
1974 22-30	22-30 6/ PA	5742937	2197 81 2	261		2016 40 LGR	16 2,5 x 40/ PP	5219132	2228 21 1	272	
1974 2X12-25	12-25 6/ PA	5742579	2197 86 3	261	1339414	2016 40 RW	16 2,5 x 40/ PP	5216674	2226 21 9	273	
1974 2X4-12	4-12 6/ PA	5742630	2197 85 5	261	1339413	2016 50 LGR	16 2,5 x 50/ PP	5219194	2228 23 8	272	
						2016 50 RW	16 2,5 x 50/ PP	5216735	2226 22 7	273	
1975 12-15	12-15 / PA	5844518	2148 02 1	261							
1975 16-19	16-19 / PA	5844570	2148 04 8	261		2018 40 LGR	18 2,5 x 40/ PP	5219255	2228 30 0	272	
1975 19-22	19-22,5 / PA	5844631	2148 05 6	261		2018 40 RW	18 2,5 x 40/ PP	5216797	2226 30 8	273	
						2018 50 LGR	18 2,5 x 50/ PP	5219316	2228 31 9	272	
1976 12-15	12-15,5 190 N/ PA	5863779	2148 50 1	261							
1976 16-21	16-21,5 500 N/ PA	5863830	2148 52 8	261		2020 40 LGR	20 2,5 x 40/ PP	5219378	2228 40 8	272	
1976 22-28	22-28,5 500 N/ PA	5863892	2148 53 6	261		2020 40 RW	20 2,5 x 40/ PP	5216919	2226 40 5	273	
						2020 50 LGR	20 2,5 x 50/ PP	5219439	2228 41 6	272	
1996 40	3 x 40 läpinäkyvä/ PP	5705796	2222 83 3	271							
1996 50	3,5 x 50 läpinäkyvä/ PP	5705734	2222 84 1	271		2025 18 LGR	2 x 184-7 / PP	5219552	2228 61 0	272	1319507
1996 60	3,5 x 60 läpinäkyvä/ PP	5707837	2222 86 8	271		2025 18 RW	2,0 x 184-7 / PP	5496519	2228 68 6	272	
1996 70	3,5 x 70 läpinäkyvä/ PP	5509837	2222 87 6	271		2025 25 LGR	2 x 254-7 / PP	5219613	2228 62 9	272	1319508
						2025 25 RW	2,0 x 254-7 / PP	5828556	2228 68 8	272	
1996 N 25	25/3 / St / G	5545590	3369 00 3	378							
1996 N 40	40/3 / St / G	5545774	3369 00 5	378		2026 18 LGR	2 x 187-12 / PP	5219675	2228 71 8	272	1319512
1996 N 60	60/3,5 / St / G	5545897	3369 02 1	378		2026 18 RW	2,0 x 187-12 / PP	5496397	2228 42 0	272	
						2026 25 LGR	2 x 257-12 / PP	5219736	2228 72 6	272	
1996 O	3,0 - 3,5 läpinäkyvä/ PP	5698357	2222 80 9	271		2026 25 LGR SP	2 x 257-12 / PP	5608110	2228 43 2	272	
						2026 25 RW	2,0 x 257-12 / PP	5496458	2228 42 2	272	
2004 18 LGR	4 2,0 x 18/ PP	5217275	2227 22 3	272		2026 35 LGR	2 x 357-12 / PP	5219798	2228 73 4	272	1319513
2004 18 RW	4 2,0 x 18/ PP	5214878	2225 22 0	273		2026 35 LGR SP	2 x 357-12 / PP	5608172	2228 44 0	272	
2004 25 LGR	4 2,0 x 25/ PP	5217336	2227 23 1	272		2026 45 LGR	2 x 457-12 / PP	5608837	2228 75 0	272	
2004 25 RW	4 2,0 x 25/ PP	5214939	2225 23 9	273							
						2027 25 LGR	2 x 2510-14 / PP	5219859	2228 82 3	272	
2005 18 LGR	5 2,0 x 18/ PP	5217459	2227 34 7	272		2027 30 LGR	2 x 3010-14 / PP	5219910	2228 83 1	272	1319514
2005 18 RW	5 2,0 x 18/ PP	5215059	2225 37 9	273		2027 40 LGR	2 x 4010-14 / PP	5219972	2228 85 8	272	
2005 25 LGR	5 2,0 x 25/ PP	5217398	2227 33 9	272							
2005 25 RW	5 2,0 x 25/ PP	5214991	2225 34 4	273		2028 40 LGR	2 x 4013,5-17 / PP	5220039	2228 90 4	272	
2006 18 RW	6 2,0 x 18/ PP	5215110	2225 40 9	273							
2006 25 LGR	6 2,0 x 25/ PP	5217572	2227 42 8	272		2031 10	10 vaaleanharmaa / PP	5726951	2205 39 8	263	1317440
2006 25 RW	6 2,0 x 25/ PP	5215172	2225 41 7	273		2031 20	15 vaaleanharmaa / PP	5651635	2205 40 4	263	1317441
2006 35 LGR	6 2,0 x 35/ PP	5217633	2227 43 6	272		2031 20 SP	15 vaaleanharmaa / PP	5651642	2205 40 8	263	
2006 35 RW	6 2,0 x 35/ PP	5215233	2225 42 5	273							
						2031 40	30 vaaleanharmaa / PP	5651666	2205 41 6	263	1317442
2007 18 RW	7 2,0 x 18/ PP	5215295	2225 50 6	273		2031 40 SP	30 vaaleanharmaa / PP	5651703	2205 42 0	263	
2007 25 LGR	7 2,0 x 25/ PP	5217756	2227 51 7	272		2031 F 10	10 kivenharmaa / PP	5726968	2205 40 0	263	
2007 25 RW	7 2,0 x 25/ PP	5215356	2225 51 4	273		2031 F 20	15 kivenharmaa / PP	5651659	2205 41 2	263	
2007 25 SW	7 2,0 x 25/ PP	5336372	2232 14 6	273							
2007 35 LGR	7 2,0 x 35/ PP	5217817	2227 52 5	272		2031 F 40	30 kivenharmaa / PP	5651710	2205 42 3	263	
2007 35 RW	7 2,0 x 35/ PP	5215417	2225 52 2	273							
						2031 M 15 FS	1550/ St / FS	5863953	2207 02 8	277	1317423
2008 25 LGR	8 2,0 x 25/ PP	5217930	2227 61 4	272		2031 M 30 FS	3025/ St / FS	5798798	2207 03 6	277	1317426
2008 25 RW	8 2,0 x 25/ PP	5215530	2225 61 1	273		2031 M 70 FS	7010/ St / FS	5022497	2207 06 0	277	1317417
2008 25 SW	8 2,0 x 25/ PP	5336310	2232 17 0	273							
2008 35 LGR	8 2,0 x 35/ PP	5217992	2227 62 2	272		2032	8 vaaleanharmaa / PA	5211273	2205 01 7	264	
2008 35 RW	8 2,0 x 35/ PP	5215592	2225 63 8	273		2032 F	8 kivenharmaa / PBPT	5211099	2204 90 8	264	
2008 45 LGR	8 2,0 x 45/ PP	5218050	2227 63 0	272		2032 SD	8 vaaleanharmaa / PA	5210917	2204 80 0	264	1317431
						2032 SD SP	8 vaaleanharmaa / PA	5597490	2204 85 1	264	
2009 20 RW	9 2,0 x 20/ PP	5215714	2225 70 0	273		2032 SP	8 vaaleanharmaa / PA	5597674	2204 97 5	264	
2009 25 LGR	9 2,0 x 25/ PP	5218173	2227 71 1	272							
2009 25 RW	9 2,0 x 25/ PP	5215776	2225 71 9	273		2033	16 vaaleanharmaa / PA	5211334	2205 03 3	264	1317478
2009 25 SW	9 2,0 x 25/ PP	5336198	2232 21 9	273		2033 D 15x3 G	156,4/ St / G	5044970	2205 09 7	276	
2009 35 LGR	9 2,0 x 35/ PP	5218234	2227 73 8	272		2033 D 25x19	vaaleanharmaa 2400/ PS	5211457	2205 09 2	265	
2009 35 LGR SP	9 2,0 x 35/ PP	5607694	2227 76 2	272		2033 F	16 kivenharmaa / PBPT	5211150	2204 91 6	264	
2009 35 RW	9 2,0 x 35/ PP	5215837	2225 72 7	273		2033 M	1625/ V2A	5036616	2204 00 0	276	1317435
2009 45 LGR	9 2,0 x 45/ PP	5218296	2227 74 6	272		2033 SD	16 vaaleanharmaa / PA	5210979	2204 81 9	264	1317433
2009 45 LGR SP	9 2,0 x 45/ PP	5607878	2227 79 7	272		2033 SD SP	16 vaaleanharmaa / PA	5597551	2204 87 8	264	
						2033 SP	16 vaaleanharmaa / PA	5597735	2204 98 3	264	
2010 25 LGR	10 2,0 x 25/ PP	5218357	2227 80 0	272		2033 STD	16 vaaleanharmaa / PA	5693253	2204 54 1	264	
2010 25 RW	10 2,0 x 25/ PP	5215899	2225 80 8	273							
2010 25 SW	10 2,0 x 25/ PP	5336136	2232 23 5	273		2034	10 vaaleanharmaa / PA	5211396	2205 04 1	264	1317480
2010 35 LGR	10 2,0 x 35/ PP	5218418	2227 81 9	272		2034 F	10 kivenharmaa / PBPT	5211211	2204 92 4	264	
2010 35 RW	10 2,0 x 35/ PP	5215950	2225 81 6	273		2034 M	1050/ V2A	5210672	2204 01 0	276	1317436
2010 45 LGR	10 2,0 x 45/ PP	5218470	2227 82 7	272		2034 SP	10 vaaleanharmaa / PA	5597797	2204 99 1	264	
2011 25 RW	11 2,0 x 25/ PP	5216070	2225 90 5	273		2036 10-15 LGR	10-15 vaaleanharmaa / PE	5223092	2259 14 1	346	
2011 35 LGR	11 2,0 x 35/ PP	5218593	2227 91 6	272		2036 18-23 LGR	18-23 vaaleanharmaa / PE	5223214	2259 23 0	346	
2011 35 RW	11 2,0 x 35/ PP	5216131	2225 91 3	273		2036 22-28 LGR	22-28 vaaleanharmaa / PE	5223276	2259 28 1	346	
2011 45 LGR	11 2,0 x 45/ PP	5218654	2227 92 4	272		2036 4-7 LGR	4-7 vaaleanharmaa / PE	5222972	2259 07 9	346	
2012 25 RW	12 2,0 x 25/ PP	5216254	2226 01 4	273		2037 12-20 LGR	12-20 vaaleanharmaa / PA	5221418	2250 20 9	266	1339362
2012 35 LGR	12 2,0 x 35/ PP	5218777	2228 02 5	272		2037 16-24 LGR	16-24 vaaleanharmaa / PA	5221470	2250 24 1	266	1339363
2012 35 RW	12 2,0 x 35/ PP	5216315	2226 02 2	273		2037 18-30 LGR	18-30 vaaleanharmaa / PA	5221531	2250 30 6	266	1339364
2012 35 SW	12 2,0 x 35/ PP	5335955	2232 31 6	273		2037 27-43 LGR	27-43 vaaleanharmaa / PA	5221593	2250 43 8	266	1339365
2012 45 LGR	12 2,0 x 45/ PP	5218838	2228 03 3	272		2037 3-7 LGR	3-7 vaaleanharmaa / PA	5221296	2250 07 1	266	1339360
						2037 6-13 LGR	6-13 vaaleanharmaa / PA	5221357	2250 13 6	266	1339361
2014 30 RW	14 2,5 x 30/ PP	5216438	2226 10 3	273							

Tyyppiluetelo

EAN-numeron rakenne: maatumnus 40

valmistajan tunnus 1219 (tuotenumeroille, jotka alkavat numerolla 0 pätee: 1010)

yksilöllinen EAN-C 5647589

Tyyppi	Mitat/väri/eril.	EAN-C.	Tuoteno	Side	FI-nr.	Tyyppi	Mitat/väri/eril.	EAN-C.	Tuoteno	Side	FI-nr.
2047 5-25 LGR	5-25 vaaleanharmaa/ PS	5221654	2251 25 6	345		2056 76 VA	70-76 / V2A	5064275	1159 62 3	360	
2049 4-14 LGR	4-14 M3 x 17/ PS	5222071	2254 01 8	344		2056 82 FT	76-82 / St / FT	5065173	1160 82 6	357	1339614
2050 5-25 LGR	5-25 M4 x 27/ PS	5222132	2254 02 6	345		2056 90 FT	82-90 / St / FT	5065234	1160 90 7	357	1339615
2051 8-36 LGR	8-36 M4 x 37,5/ PS	5222194	2254 03 4	345		2056 B 35 FT	35 x 50/35 / St / FT	5081258	1194 05 4	373	1463217
2054 14-48 LGR	14-48 M 8x55/ PA	5222798	2255 01 4	345		2056 B 40 FT	40 x 100/40 / St / FT	5081197	1194 04 6	373	1463218
2054 14-48 PA	14-48 M 8x55/ PA	5905592	2255 40 5	345		2056 B 80 FT	80 x 100/80 / St / FT	5081319	1194 08 9	373	1463219
2055 24-72 LGR	24-72 M8 x 75/ PA	5222859	2255 02 2	345		2056 B 80 VA	80 x 100/80 / V2A	5476771	1194 37 2	373	
						2056 BE FT	/ St / FT	5072492	1174 05 3	363	
2056 100 FT	90-100 / St / FT	5065296	1160 99 0	357	1339616	2056 E 31 FT	28-31 / St / FT	5500353	1174 60 6	372	
2056 12 ALU	8-12 / AI	5077299	1183 20 6	358	1339152	2056 E 37 FT	34-37 / St / FT	5500414	1174 61 4	372	
2056 12 FT	8-12 / St / FT	5064459	1160 12 5	357	1339602	2056 E 44 FT	40-44 / St / FT	5500476	1174 63 0	372	
2056 12 VA	8-12 / V2A	5063612	1159 51 8	360		2056 M 100 FT	90-100 / St / FT	5063551	1156 16 0	361	
2056 16 ALU	12-16 / AI	5077350	1183 21 4	358	1339154	2056 M 12 FT	8-12 / St / FT	5062714	1156 00 4	361	1339302
2056 16 FT	12-16 / St / FT	5064510	1160 16 8	357	1339603	2056 M 12 VA	8-12 / V2A	5668190	1159 71 2	362	
2056 16 VA	12-16 / V2A	5063674	1159 52 6	360		2056 M 16 FT	12-16 / St / FT	5062776	1156 01 2	361	1339303
2056 2 12 ALU	8-12 / AI	5435495	1183 38 9	359	1339202	2056 M 16 VA	12-16 / V2A	5668206	1159 71 6	362	
2056 2 12 FT	8-12 / St / FT	5065357	1161 12 1	357	1339617	2056 M 22 FT	16-22 / St / FT	5062837	1156 02 0	361	1339304
2056 2 16 ALU	12-16 / AI	5435556	1183 39 7	359	1339204	2056 M 22 VA	16-22 / V2A	5668213	1159 72 2	362	
2056 2 16 FT	12-16 / St / FT	5065418	1161 16 4	357	1339618	2056 M 28 FT	22-28 / St / FT	5062899	1156 03 9	361	1339305
2056 2 16 ALU	12-16 / AI	5435617	1183 40 0	359	1339206	2056 M 28 VA	22-28 / V2A	5668220	1159 72 8	362	
2056 2 22 ALU	16-22 / AI	5435679	1183 41 9	359	1339208	2056 M 34 FT	28-34 / St / FT	5062950	1156 04 7	361	1339306
2056 2 22 FT	16-22 / St / FT	5065470	1161 22 9	357	1339619	2056 M 34 VA	28-34 / V2A	5668268	1159 73 4	362	
2056 2 22 VA	16-22 / V2A	5066071	1161 82 2	360		2056 M 40 FT	34-40 / St / FT	5063018	1156 05 5	361	1339307
2056 2 28 ALU	22-28 / AI	5435679	1183 41 9	359	1339208	2056 M 40 VA	34-40 / V2A	5668275	1159 74 0	362	
2056 2 28 FT	22-28 / St / FT	5065531	1161 28 8	357	1339620	2056 M 46 FT	40-46 / St / FT	5063070	1156 06 3	361	1339308
2056 2 28 VA	22-28 / V2A	5066132	1161 83 0	360		2056 M 46 VA	40-46 / V2A	5668282	1159 74 6	362	
2056 2 34 ALU	28-34 / AI	5435730	1183 42 7	359	1339210	2056 M 52 FT	46-52 / St / FT	5063131	1156 07 1	361	1339309
2056 2 34 FT	28-34 / St / FT	5065593	1161 34 2	357	1339621	2056 M 52 VA	46-52 / V2A	5668299	1159 75 2	362	
2056 2 34 VA	28-34 / V2A	5066194	1161 84 9	360		2056 M 58 FT	52-58 / St / FT	5063193	1156 09 8	361	1339310
2056 2 40 ALU	34-40 / AI	5435792	1183 43 5	359	1339212	2056 M 58 VA	52-58 / V2A	5668305	1159 75 8	362	
2056 2 40 FT	34-40 / St / FT	5065654	1161 40 7	357	1339622	2056 M 64 FT	58-64 / St / FT	5063254	1156 10 1	361	1339311
2056 2 40 VA	34-40 / V2A	5066255	1161 85 7	360		2056 M 64 VA	58-64 / V2A	5668312	1159 76 4	362	
2056 2 46 ALU	40-46 / AI	5435853	1183 44 3	359	1339214	2056 M 70 FT	64-70 / St / FT	5063315	1156 12 8	361	
2056 2 46 FT	40-46 / St / FT	5065715	1161 46 6	357	1339623	2056 M 70 VA	64-70 / V2A	5668329	1159 77 0	362	
2056 2 46 VA	40-46 / V2A	5066316	1161 86 5	360		2056 M 76 FT	70-76 / St / FT	5063377	1156 13 6	361	
2056 2 52 ALU	46-52 / AI	5435914	1183 45 1	359	1339216	2056 M 76 VA	70-76 / V2A	5668336	1159 77 6	362	
2056 2 52 FT	46-52 / St / FT	5065777	1161 52 0	357	1339624	2056 M 82 FT	76-82 / St / FT	5063438	1156 14 4	361	
2056 2 52 VA	46-52 / V2A	5066378	1161 87 3	360		2056 M 82 VA	76-82 / V2A	5063490	1156 15 2	361	
2056 2 58 ALU	52-58 / AI	5435976	1183 47 8	359	1339218	2056 M 90 FT	82-90 / St / FT	5063490	1156 15 2	361	
2056 2 58 FT	52-58 / St / FT	5065838	1161 57 1	357	1339625	2056 M2 12 FT	8-12 / St / FT	5494836	1156 17 9	361	
2056 2 58 VA	52-58 / V2A	5066439	1161 88 1	360		2056 M2 12 VA	8-12 / V2A	5668343	1161 91 2	363	
2056 2 64 FT	58-64 / St / FT	5065890	1161 64 4	357		2056 M2 16 FT	12-16 / St / FT	5494898	1156 18 7	361	
2056 2 64 VA	58-64 / V2A	5066491	1161 90 3	360		2056 M2 16 VA	12-16 / V2A	5668381	1161 91 6	363	
2056 22 ALU	16-22 / AI	5077411	1183 22 2	358	1339156	2056 M2 22 FT	16-22 / St / FT	5494959	1156 19 5	361	
2056 22 FT	16-22 / St / FT	5064572	1160 22 2	357	1339604	2056 M2 22 VA	16-22 / V2A	5668398	1161 92 2	363	
2056 22 VA	16-22 / V2A	5063735	1159 53 4	360		2056 M2 28 FT	22-28 / St / FT	5958703	1156 20 9	361	
2056 28 ALU	22-28 / AI	5077473	1183 23 0	358	1339158	2056 M2 28 VA	22-28 / V2A	5668404	1161 92 8	363	
2056 28 FT	22-28 / St / FT	5064633	1160 28 1	357	1339605	2056 M2 34 VA	28-34 / V2A	5668442	1161 93 4	363	
2056 28 VA	22-28 / V2A	5063797	1159 54 2	360		2056 M2 40 VA	34-40 / V2A	5668459	1161 94 0	363	
2056 3 12 FT	8-12 / St / FT	5066972	1162 12 8	358	1339626	2056 M2 46 VA	40-46 / V2A	5668466	1161 94 6	363	
2056 3 16 FT	12-16 / St / FT	5067030	1162 16 0	358	1339627	2056 M2 52 VA	46-52 / V2A	5668503	1161 95 2	363	
2056 3 22 ALU	16-22 / AI	5436218	1183 52 4	359	1339256	2056 M2 58 VA	52-58 / V2A	5668510	1161 95 8	363	
2056 3 22 FT	16-22 / St / FT	5067092	1162 22 5	358	1339628	2056 M2 64 FT	58-64 / V2A	5668527	1161 96 4	363	
2056 3 28 ALU	22-28 / AI	5436270	1183 53 2	359	1339258	2056 M3 12 FT	8-12 / St / FT	5958765	1156 24 1	362	
2056 3 28 FT	22-28 / St / FT	5067153	1162 28 4	358	1339629	2056 M3 16 FT	12-16 / St / FT	5958826	1156 26 8	362	
2056 3 34 ALU	28-34 / AI	5436331	1183 54 0	359	1339260	2056 M3 22 FT	16-22 / St / FT	5958888	1156 27 6	362	
2056 3 34 FT	28-34 / St / FT	5067214	1162 34 9	358	1339630	2056 M3 28 FT	22-28 / St / FT	5958949	1156 28 4	362	
2056 3 40 FT	34-40 / St / FT	5067276	1162 40 3	358	1339631	2056F 12 ALU	8-12 / AI	5440239	1184 70 9	368	
2056 3 46 FT	40-46 / St / FT	5067337	1162 46 2	358	1339632	2056F 12 FT	8-12 / St / FT	5070634	1169 12 2	367	
2056 34 ALU	28-34 / AI	5077534	1183 24 9	358	1339160	2056F 12 VA	8-12 / V2A	5077893	1185 00 4	368	
2056 34 FT	28-34 / St / FT	5064695	1160 34 6	357	1339606	2056F 16 ALU	12-16 / AI	5440291	1184 71 7	368	
2056 34 VA	28-34 / V2A	5063858	1159 55 0	360		2056F 16 FT	12-16 / St / FT	5070696	1169 16 5	367	
2056 40 ALU	34-40 / AI	5077596	1183 25 7	358	1339162	2056F 16 VA	12-16 / V2A	5077954	1185 01 2	368	
2056 40 FT	34-40 / St / FT	5064756	1160 40 0	357	1339607	2056F 22 FT	8-12 / St / FT	5071532	1170 12 0	367	
2056 40 VA	34-40 / V2A	5063919	1159 56 9	360		2056F 22 VA	12-16 / V2A	5071594	1170 16 3	367	1339130
2056 46 ALU	40-46 / AI	5077657	1183 26 5	358	1339164	2056F 22 FT	16-22 / St / FT	5071655	1170 22 8	367	
2056 46 FT	40-46 / St / FT	5064817	1160 45 1	357	1339608	2056F 22 VA	16-22 / V2A	5071716	1170 28 7	367	
2056 46 VA	40-46 / V2A	5063971	1159 57 7	360		2056F 28 ALU	22-28 / AI	5440011	1184 73 3	368	
2056 52 ALU	46-52 / AI	5077718	1183 27 3	358	1339166	2056F 28 FT	22-28 / St / FT	5070818	1169 28 9	367	
2056 52 FT	46-52 / St / FT	5064879	1160 52 4	357	1339609	2056F 28 VA	22-28 / V2A	5078074	1185 03 9	368	
2056 52 VA	46-52 / V2A	5064039	1159 58 5	360		2056F 34 ALU	28-34 / AI	5440475	1184 74 1	368	
2056 58 ALU	52-58 / AI	5077770	1183 28 1	358	1339168	2056F 34 FT	28-34 / St / FT	5070870	1169 34 3	367	
2056 58 FT	52-58 / St / FT	5064930	1160 58 3	357	1339610	2056F 34 VA	28-34 / V2A	5078135	1185 04 7	368	
2056 58 VA	52-58 / V2A	5064091	1159 59 3	360		2056F 40 ALU	34-40 / AI	5440536	1184 76 8	368	
2056 64 ALU	58-64 / AI	5077831	1183 30 3	358	1339170	2056F 40 FT	34-40 / St / FT	5070931	1169 40 8	367	
2056 64 FT	58-64 / St / FT	5064992	1160 64 8	357	1339611	2056F 40 VA	34-40 / V2A	5078197	1185 05 5	368	
2056 64 VA	58-										

Tyyppi	Mitat/väri/eril.	EAN-C.	Tuoteno	Side	FI-nr.	Tyyppi	Mitat/väri/eril.	EAN-C.	Tuoteno	Side	FI-nr.
2056F 52 VA	46-52 / V2A	5078319	1185 07 1	368		2056U 2 12 FT	8-12 / St / FT	5073635	1176 12 9	364	
2056F 58 FT	52-58 / St / FT	5071112	1169 58 0	367		2056U 2 16 FT	12-16 / St / FT	5073697	1176 16 1	364	
2056F 58 VA	52-58 / V2A	5078371	1185 09 8	368		2056U 2 22 FT	16-22 / St / FT	5073758	1176 22 6	364	
2056F 64 FT	58-64 / St / FT	5071174	1169 64 5	367		2056U 2 28 FT	22-28 / St / FT	5073819	1176 28 5	364	
2056F 64 VA	58-64 / V2A	5078432	1185 10 1	368		2056U 2 34 FT	28-34 / St / FT	5073871	1176 33 1	364	
2056F 70 FT	64-70 / St / FT	5071235	1169 69 6	367		2056U 2 40 FT	34-40 / St / FT	5073932	1176 40 4	364	
2056F 76 FT	70-76 / St / FT	5071297	1169 76 9	367		2056U 2 46 FT	40-46 / St / FT	5073994	1176 46 3	364	
2056F 82 FT	76-82 / St / FT	5071358	1169 82 3	367		2056U 2 52 FT	46-52 / St / FT	5074052	1176 52 8	364	
2056F 90 FT	82-90 / St / FT	5071419	1169 90 4	367		2056U 2 58 FT	52-58 / St / FT	5074113	1176 58 7	364	
2056F M 12 FT	8-12 / St / FT	5495192	1156 80 2	369		2056U 22 ALU	16-22 / AI	5439158	1184 42 3	366	1339106
2056F M 16 FT	12-16 / St / FT	5495253	1156 81 0	369		2056U 22 FT	16-22 / St / FT	5072850	1175 21 1	364	
2056F M 22 FT	16-22 / St / FT	5495314	1156 82 9	369		2056U 22 VA	16-22 / V2A	5074717	1178 52 0	365	
2056F M 28 FT	22-28 / St / FT	5495376	1156 83 7	369		2056U 28 ALU	22-28 / AI	5439219	1184 43 1	366	1339108
2056N 12 ALU	8-12 / AI	5436515	1183 60 5	355	1339687	2056U 28 FT	22-28 / St / FT	5072911	1175 28 9	364	
2056N 12 FT	8-12 / St / FT	5067399	1163 12 4	354	1339560	2056U 28 VA	22-28 / V2A	5074779	1178 53 9	365	
2056N 12 VA	8-12 / V2A	5069256	1166 01 8	355		2056U 3 12 FT	8-12 / St / FT	5074175	1177 12 5	365	
2056N 16 ALU	12-16 / AI	5436577	1183 61 3	355	1339688	2056U 3 16 FT	12-16 / St / FT	5074236	1177 16 8	365	
2056N 16 FT	12-16 / St / FT	5067450	1163 16 7	354	1339561	2056U 3 22 FT	16-22 / St / FT	5074298	1177 22 2	365	
2056N 16 VA	12-16 / V2A	5069317	1166 02 6	355		2056U 3 28 FT	22-28 / St / FT	5074359	1177 28 1	365	
2056N 2 12 FT	8-12 / St / FT	5068297	1164 12 0	354	1339580	2056U 3 34 FT	28-34 / St / FT	5074410	1177 34 6	365	
2056N 2 16 FT	12-16 / St / FT	5068358	1164 16 3	354	1339581	2056U 3 40 FT	34-40 / St / FT	5074472	1177 40 0	365	
2056N 2 22 FT	16-22 / St / FT	5068419	1164 22 8	354	1339582	2056U 3 46 FT	40-46 / St / FT	5074533	1177 45 1	365	
2056N 2 28 FT	22-28 / St / FT	5068471	1164 28 7	354	1339583	2056U 34 ALU	28-34 / AI	5439271	1184 45 8	366	1339110
2056N 2 34 FT	28-34 / St / FT	5068532	1164 34 1	354	1339584	2056U 34 FT	28-34 / St / FT	5072973	1175 34 3	364	
2056N 2 40 FT	34-40 / St / FT	5068594	1164 40 6	354	1339585	2056U 34 VA	28-34 / V2A	5074830	1178 54 7	365	
2056N 2 46 FT	40-46 / St / FT	5068655	1164 46 5	354	1339586	2056U 40 ALU	34-40 / AI	5439332	1184 46 6	366	1339112
2056N 2 52 FT	46-52 / St / FT	5068716	1164 51 1	354	1339587	2056U 40 FT	34-40 / St / FT	5073031	1175 40 8	364	
2056N 2 58 FT	52-58 / St / FT	5068778	1164 58 9	354	1339588	2056U 40 VA	34-40 / V2A	5074892	1178 55 5	365	
2056N 22 ALU	16-22 / AI	5436638	1183 62 1	355	1339689	2056U 46 ALU	40-46 / AI	5439394	1184 47 4	366	1339114
2056N 22 FT	16-22 / St / FT	5067511	1163 22 1	354	1339562	2056U 46 FT	40-46 / St / FT	5073093	1175 46 7	364	
2056N 22 VA	16-22 / V2A	5069379	1166 03 4	355		2056U 46 VA	40-46 / V2A	5074953	1178 56 3	365	
2056N 28 ALU	22-28 / AI	5436690	1183 64 8	355	1339690	2056U 52 ALU	46-52 / AI	5439455	1184 48 2	366	1339116
2056N 28 FT	22-28 / St / FT	5067573	1163 28 0	354	1339563	2056U 52 FT	46-52 / St / FT	5073154	1175 52 1	364	
2056N 28 VA	22-28 / V2A	5069430	1166 04 2	355		2056U 52 VA	46-52 / V2A	5075011	1178 57 1	365	
2056N 34 ALU	28-34 / AI	5436751	1183 65 6	355	1339691	2056U 58 ALU	52-58 / AI	5439516	1184 49 0	366	1339118
2056N 34 FT	28-34 / St / FT	5067634	1163 34 5	354	1339564	2056U 58 FT	52-58 / St / FT	5073215	1175 58 0	364	
2056N 34 VA	28-34 / V2A	5069492	1166 05 0	355		2056U 58 VA	52-58 / V2A	5075073	1178 59 8	365	
2056N 40 ALU	34-40 / AI	5436812	1183 66 4	355	1339692	2056U 64 ALU	58-64 / AI	5439578	1184 50 4	366	1339120
2056N 40 FT	34-40 / St / FT	5067696	1163 39 6	354	1339565	2056U 64 FT	58-64 / St / FT	5073277	1175 64 5	364	
2056N 40 VA	34-40 / V2A	5069553	1166 06 9	355		2056U 64 VA	58-64 / V2A	5075134	1178 60 1	365	
2056N 46 ALU	40-46 / AI	5436874	1183 67 2	355	1339693	2056U 70 ALU	64-70 / AI	5439752	1184 53 9	366	1339122
2056N 46 FT	40-46 / St / FT	5067757	1163 46 9	354	1339566	2056U 70 FT	64-70 / St / FT	5073338	1175 69 6	364	
2056N 46 VA	40-46 / V2A	5069614	1166 07 7	355		2056U 70 VA	64-70 / V2A	5075196	1178 62 8	365	
2056N 52 ALU	46-52 / AI	5436935	1183 68 0	355	1339694	2056U 76 ALU	70-76 / AI	5439639	1184 51 2	366	1339124
2056N 52 FT	46-52 / St / FT	5067818	1163 52 3	354	1339567	2056U 76 FT	70-76 / St / FT	5073390	1175 76 9	364	
2056N 52 VA	46-52 / V2A	5069676	1166 08 5	355		2056U 76 VA	70-76 / V2A	5075257	1178 63 6	365	
2056N 58 FT	52-58 / St / FT	5067870	1163 58 2	354	1339568	2056U 82 FT	76-82 / St / FT	5073451	1175 82 3	364	
2056N 58 VA	52-58 / V2A	5069737	1166 09 3	355		2056U 90 FT	82-90 / St / FT	5073512	1175 90 4	364	
2056N 58ALU	52-58 / AI	5436997	1183 69 9	355	1339695	2056U M 12 FT	8-12 / St / FT	5498254	1158 00 7	366	
2056N 64 FT	58-64 / St / FT	5067931	1163 64 7	354	1339569	2056U M 16 FT	12-16 / St / FT	5498315	1158 01 5	366	
2056N 64 VA	58-64 / V2A	5069799	1166 10 7	355		2056U M 22 FT	16-22 / St / FT	5498377	1158 02 3	366	
2056N 70 FT	64-70 / St / FT	5067993	1163 70 1	354	1339570	2056U M 28 FT	22-28 / St / FT	5498438	1158 03 1	366	
2056N M 12 FT	8-12 / St / FT	5060857	1155 40 7	356	1339650	2056U M 34 FT	28-34 / St / FT	5498490	1158 05 8	366	
2056N M 16 FT	12-16 / St / FT	5060918	1155 41 5	356	1339651	2056U M 40 FT	34-40 / St / FT	5498551	1158 06 6	366	
2056N M 22 FT	16-22 / St / FT	5060970	1155 42 3	356	1339652	2056U M 46 FT	40-46 / St / FT	5498612	1158 07 4	366	
2056N M 28 FT	22-28 / St / FT	5061038	1155 43 1	356	1339653	2056U M 52 FT	46-52 / St / FT	5498674	1158 08 2	366	
2056N M 34 FT	28-34 / St / FT	5061090	1155 45 8	356	1339654	2056U M 58 FT	52-58 / St / FT	5498735	1158 09 0	366	
2056N M 40 FT	34-40 / St / FT	5061151	1155 46 6	356	1339655	2056U M 64 FT	58-64 / St / FT	5498797	1158 10 4	366	
2056N M 46 FT	40-46 / St / FT	5061212	1155 47 4	356	1339656	2056U M 70 FT	64-70 / St / FT	5498858	1158 11 2	366	
2056N M 52 FT	46-52 / St / FT	5061274	1155 48 2	356	1339657	2056U M 76 FT	70-76 / St / FT	5498919	1158 12 0	366	
2056N M 58 FT	52-58 / St / FT	5061335	1155 49 0	356	1339658	2056U-E28 FT	25-28 / St / FT	5451211	1174 50 9	373	
2056N SAS 12 VA	8-12 / V2A	5432432	1167 01 4	356		2056U-E31 FT	28-31 / St / FT	5072553	1174 54 1	373	
2056N SAS 16 VA	12-16 / V2A	5432494	1167 02 2	356		2056U-E34 FT	31-34 / St / FT	5451273	1174 51 7	373	
2056N SAS 22 VA	16-22 / V2A	5432555	1167 03 0	356		2056U-E37 FT	34-37 / St / FT	5072614	1174 56 8	373	
2056N SAS 28 VA	22-28 / V2A	5432616	1167 04 9	356		2056U-E40 FT	37-40 / St / FT	5451334	1174 52 5	373	
2056N SAS 8 VA	4-8 / V2A	5432371	1167 00 6	356		2056U-E44 FT	40-44 / St / FT	5072676	1174 57 6	373	
2056R M 22 FS	16-22 / St / FS	5236597	1158 41 0	372	1339836	2056W 12 ALU	8-12 / AI	5437710	1184 00 8	371	
2056R M 28 FS	22-28 / St / FS	5236603	1158 41 4	372	1339837	2056W 12 FT	8-12 / St / FT	5075431	1180 12 6	370	
2056R M 34 FS	28-34 / St / FS	5236610	1158 41 8	372	1339838	2056W 16 ALU	12-16 / AI	5437772	1184 01 6	371	
2056R M 40 FS	34-40 / St / FS	5236627	1158 42 2	372	1339839	2056W 16 FT	12-16 / St / FT	5075493	1180 16 9	370	
2056RS M 16 FT	12-16 / St / FT	5358411	1158 30 5	372	1339827	2056W 2 12 FT	8-12 / St / FT	5076339	1181 12 2	370	
2056RS M 22 FT	16-22 / St / FT	5358428	1158 30 9	372	1339828	2056W 2 16 FT	12-16 / St / FT	5076391	1181 16 5	370	1339132
2056RS M 28 FT	22-28 / St / FT	5358435	1158 31 3	372	1339829	2056W 2 22 FT	16-22 / St / FT	5076452	1181 21 1	370	
2056RS M 34 FT	28-34 / St / FT	5358442	1158 31 7	372	1339830	2056W 2 28 FT	22-28 / St / FT	5076513	1181 28 9	370	
2056RS M 40 FT	34-40 / St / FT	5358473	1158 32 1	372	1339831	2056W 2 34 FT	28-34 / St / FT	5076575	1181 34 3	370	
2056RS M 46 FT	40-46 / St / FT	5358480	1158 32 5	372	1339832	2056W 2 40 FT	34-40 / St / FT	5076636	1181 40 8	370	
2056RS M 52 FT	46-52 / St / FT	5358497	1158 32 9	372	1339833	2056W 2 46 FT	40-46 / St / FT	5076698	1181 46 7	370	
20											

Tyyppiluettelo

EAN-numeron rakenne: maatumnus **40**

valmistajan tunnus **1219** (tuotenumeroille, jotka alkavat numerolla **0** pätee: **1010**)

yksilöllinen EAN-C **5647589**

Tyyppi	Mitat/väri/eril.	EAN-C.	Tuotenro	Side	FI-nr.	Tyyppi	Mitat/väri/eril.	EAN-C.	Tuotenro	Side	FI-nr.
2056W 34 FT	28-34 / St / FT	5075677	1180 34 7	370		2059 2M FS	/ St / FS	5037873	1103 12 1	328	
2056W 34 VA	28-34 / V2A	5079514	1185 45 4	371		2060 2M AB BK	/ St	5039617	1106 02 3	328	
2056W 40 ALU	34-40 / AI	5437956	1184 05 9	371		2060 2M AB FS	/ St / FS	5039730	1106 12 0	328	1339477
2056W 40 FT	34-40 / St / FT	5075738	1180 40 1	370		2060 2M FS	/ St / FS	5039433	1105 12 4	328	
2056W 40 VA	34-40 / V2A	5079576	1185 46 2	371		2060 2M VA	/ V2A	5627098	1105 12 5	329	
2056W 46 ALU	40-46 / AI	5438014	1184 06 7	371		2060 L 2M FS	/ St / FS	5040095	1106 62 7	328	
2056W 46 FT	40-46 / St / FT	5075790	1180 46 0	370		2060 L 2M VA	/ V2A	5627104	1106 62 8	328	
2056W 46 VA	40-46 / V2A	5079637	1185 47 0	371		2061 2M FS	/ St / FS	5040453	1107 12 7	329	1463202
2056W 52 ALU	46-52 / AI	5438076	1184 07 5	371		2061 L 2M FS	/ St / FS	5040811	1108 12 3	329	1339478
2056W 52 FT	46-52 / St / FT	5075851	1180 52 5	370		2062 2M BK	/ St	5041412	1109 01 4	330	
2056W 52 VA	46-52 / V2A	5079699	1185 48 9	371		2062 2M FT	/ St / FT	5041474	1109 02 2	330	1463205
2056W 58 ALU	52-58 / AI	5438137	1184 08 3	371		2062 L 2M FT	/ St / FT	5041894	1109 52 9	329	1463201
2056W 58 FT	52-58 / St / FT	5075912	1180 58 4	370		2063 2M BK	/ St	5043157	1112 02 3	331	
2056W 58 VA	52-58 / V2A	5079750	1185 49 7	371		2063 2M FS	/ St / FS	5043270	1112 12 0	331	
2056W 64 ALU	58-64 / AI	5438199	1184 09 1	371		2063 2M FT	/ St / FT	5043393	1112 22 8	331	
2056W 64 FT	58-64 / St / FT	5075974	1180 64 9	370		2063 2M VA	/ V2A	5627111	1110 00 5	331	
2056W 70 FT	64-70 / St / FT	5076032	1180 68 1	370		2063 L 2M FS	/ St / FS	5632597	1112 70 8	331	
2056W 76 FT	70-76 / St / FT	5076094	1180 76 2	370		2063 L 2M FT	/ St / FT	5632535	1112 75 9	331	1339810
2056W 82 FT	76-82 / St / FT	5076155	1180 82 7	370		2063 L 2M VA	/ V2A	5627128	1112 70 9	331	
2056W 90 FT	82-90 / St / FT	5076216	1180 90 8	370		2064 GTP 2M	/ St / GTP	5044291	1115 05 7	351	1462229
2057 M16 FT	M16/ St / FT	5033073	1193 70 8	363		2064 GTPL 2M	/ St / GTP	5044352	1115 06 5	351	1339479
2057 M20 FT	M20/ St / FT	5033134	1193 71 6	363		2065 N M4 G	M4/ St / G	5051497	1133 02 0	341	
2057 M25 FT	M25/ St / FT	5033196	1193 72 4	363							
2057 M32 FT	M32/ St / FT	5033257	1193 73 2	363							
2057 M40 FT	M40/ St / FT	5033318	1193 74 0	363							
2057 M50 FT	M50/ St / FT	5033370	1193 75 9	363							
2057 M63 FT	M63/ St / FT	5033431	1193 76 7	363							
2058 12 LGR	8-12 34/ PP	5081371	1195 12 3	374							
2058 16 LGR	12-16 34/ PP	5081432	1195 16 6	374							
2058 2 12 LGR	8-12 34/ PP	5082576	1196 11 1	375	1339337	2066 2M F	/ St / F	5046516	1117 02 5	329	1463200
2058 2 16 LGR	12-16 34/ PP	5082637	1196 16 2	375	1339338	2066 2M FS	/ St / FS	5046578	1117 03 3	329	1463204
2058 2 22 LGR	16-22 34/ PP	5082699	1196 22 7	375	1339339	2066 2M VA	/ V2A / FS	5046639	1117 06 8	329	
2058 2 28 LGR	22-28 34/ PP	5082750	1196 28 6	375	1339340						
2058 2 34 LGR	28-34 34/ PP	5082811	1196 34 0	375	1339341	2068 2M BK	/ St	5046936	1118 02 1	331	
2058 2 40 LGR	34-40 34/ PP	5082873	1196 40 5	375	1339342	2068 2M FS	/ St / FS	5047179	1118 22 6	331	1463254
2058 2 46 LGR	40-46 40/ PP	5082934	1196 46 4	375	1339343	2068 2M FT	/ St / FT	5047056	1118 12 9	331	1463252
2058 2 52 LGR	46-52 40/ PP	5082996	1196 52 9	375	1339344	2068 L 1M FT	/ St / FT	5053958	1119 67 2	332	
2058 2 58 LGR	52-58 40/ PP	5083054	1196 58 8	375	1339345						
2058 22 LGR	16-22 34/ PP	5081494	1195 22 0	374		2068 L 200 FT	/ St / FT	5060673	1119 69 6	332	
2058 28 LGR	22-28 34/ PP	5081555	1195 27 1	374							
2058 34 LGR	28-34 34/ PP	5081616	1195 34 4	374		2068 L 2M FS	/ St / FS	5864318	1119 64 8	332	1462241
2058 40 LGR	34-40 34/ PP	5081678	1195 40 9	374		2068 L 2M FT	/ St / FT	5047599	1119 65 6	332	1462243
2058 46 LGR	40-46 40/ PP	5081739	1195 46 8	374		2068 L 2M FTSOMY	/ St / FT	5204138	1119 67 0	332	
2058 52 LGR	46-52 40/ PP	5081791	1195 52 2	374		2068 L 2M VA	/ V2A	5047650	1119 70 2	332	
2058 58 LGR	52-58 40/ PP	5081852	1195 58 1	374							
2058 64 LGR	58-64 40/ PP	5081913	1195 64 6	374		2068 L 300 FT	/ St / FT	5060611	1119 69 3	332	
2058 70 LGR	64-70 40/ PP	5081975	1195 70 0	374		2068 L 400 FT	/ St / FT	5060376	1119 69 0	332	
2058 M2 12 FT	8-12 35/ St / FT	5441434	1199 70 6	375		2068 L 500 FT	/ St / FT	5060253	1119 68 7	332	
2058 M2 16 FT	12-16 35/ St / FT	5441496	1199 71 4	375		2068 L 600 FT	/ St / FT	5059417	1119 68 4	332	
2058 M2 22 FT	16-22 35/ St / FT	5441557	1199 72 2	375							
2058 M2 28 FT	22-28 35/ St / FT	5441618	1199 73 0	375		2068 L 6M VA	/ V2A	5047711	1119 72 9	332	
2058 M2 34 FT	28-34 35/ St / FT	5441670	1199 74 9	375							
2058 M2 40 FT	34-40 35/ St / FT	5441731	1199 75 7	375		2068 L 700 FT	/ St / FT	5059356	1119 68 1	332	
2058FW 100 LGR	90-100 40/ PP	5083955	1197 99 1	374	1339336	2068 L 800 FT	/ St / FT	5059295	1119 67 8	332	
2058FW 12 LGR	8-12 34/ PP	5083115	1197 12 6	374	1339322	2068 L 900 FT	/ St / FT	5056119	1119 67 5	332	
2058FW 16 LGR	12-16 34/ PP	5083177	1197 16 9	374	1339323						
2058FW 22 LGR	16-22 34/ PP	5083238	1197 22 3	374	1339324	2069 15 1.5 GTP	/ St / GTP	5044833	1115 42 1	350	1463215
2058FW 28 LGR	22-28 34/ PP	5083290	1197 28 2	374	1339325	2069 15 1.5 GTPL	/ St / GTP	5044895	1115 45 6	350	1463216
2058FW 34 LGR	28-34 34/ PP	5083351	1197 34 7	374	1339326	2069 15 2.2 GTP	/ St / GTP	5045076	1115 55 3	350	
2058FW 40 LGR	34-40 34/ PP	5083412	1197 40 1	374	1339327	2069 15 2.2 GTPL	/ St / GTP	5045199	1115 59 6	351	1462227
2058FW 46 LGR	40-46 40/ PP	5083474	1197 46 0	374	1339328	2069 1M FS	/ St / FS	5045557	1115 67 7	350	
2058FW 52 LGR	46-52 40/ PP	5083535	1197 52 5	374	1339329	2069 1M GTP	/ St / GTP	5045618	1115 68 5	350	
2058FW 58 LGR	52-58 40/ PP	5083597	1197 58 4	374	1339330	2069 2M BK	/ St	5045250	1115 61 8	350	
2058FW 64 LGR	58-64 40/ PP	5083658	1197 64 9	374	1339331	2069 2M FS	/ St / FS	5045311	1115 62 6	350	1463214
2058FW 70 LGR	64-70 40/ PP	5083719	1197 70 3	374	1339332	2069 2M GTP	/ St / GTP	5045434	1115 65 0	350	1463213
2058FW 76 LGR	70-76 40/ PP	5083771	1197 76 2	374	1339333	2069 2M GTPL	/ St / GTP	5045496	1115 66 9	350	1463212
2058FW 82 LGR	76-82 40/ PP	5083832	1197 82 7	374	1339334	2069 3M BK	/ St	5871453	1115 85 5	350	
2058FW 90 LGR	82-90 40/ PP	5083894	1197 90 8	374	1339335	2069 L 2M FS	/ St / FS	5045977	1115 80 4	350	
2058FW M 12 FT	8-12 35/ St / FT	5442035	1199 84 6	374	1339312						
2058FW M 12 VA	8-12 35/ V2A	5514091	1197 13 4	374		2070 M6 G	12-20 M5 x 14/ St / G	5120735	1380 02 8	281	
2058FW M 16 FT	12-16 35/ St / FT	5442097	1199 85 4	374	1339313	2069 T100 GTP	/ St / GTP	5440994	1115 38 2	175	1627146
2058FW M 16 VA	12-16 35/ V2A	5514152	1197 17 7	374		2069 T160 GTP	/ St / GTP	5441007	1115 38 4	175	1627148
2058FW M 22 FT	16-22 35/ St / FT	5442158	1199 86 2	374	1339314	2069 T250 GTP	/ St / GTP	5441038	1115 38 6	175	1627149
2058FW M 22 VA	16-22 35/ V2A	5514213	1197 23 1	374		2069 T350 GTP	/ St / GTP	5441045	1115 38 8	175	1627151
2058FW M 28 FT	22-28 35/ St / FT	5442219	1199 87 0	374	1339315	2069 T60 GTP	/ St / GTP	5440987	1115 38 0	175	1627144
2058FW M 28 VA	22-28 35/ V2A	5514275	1197 29 0	374							
2058FW M 34 FT	28-34 35/ St / FT	5442271	1199 88 9	374	1339316						
2058FW M 40 FT	34-40 35/ St / FT	5442332	1199 89 7	374	1339317	2071 M6 G	20-30 M5 x 20/ St / G	5120858	1380 22 2	281	
2058FW M 46 FT	40-46 35/ St / FT	5442394	1199 90 0	374	1339318						
2058FW M 52 FT	46-52 35/ St / FT	5442455	1199 91 9	374	1339319						
2058FW M 58 FT	52-58 35/ St / FT	5442516	1199 92 7	374	1339320	2072 M6 G	30-44 M5 x 22/ St / G	5120971	1380 42 7	281	
2058FW M 64 FT	58-64 35/ St / FT	5442578	1199 93 5	374	1339321	2073 M6 G	44-60 M6 x 25/ St / G	5121152	1380 72 9	281	
2058FW M 70 FT	64-70 35/ St / FT	5442639	1199 94 3	374							
2058FW M 8 VA	4-8 35/ V2A	5514039	1197 09 6	374							

01 VBS Katalog 2010_Neuer_Stand / fi / 23/11/2011 (LLEExport_01071)

Tyyppi	Mitat/väri/eril.	EAN-C.	Tuotenro	Side	FI-nr.	Tyyppi	Mitat/väri/eril.	EAN-C.	Tuotenro	Side	FI-nr.
2078 M10 1M G	M10 10/ St / G	5253396	3141 20 9	386		2953 B M25 RW	M25 puhtaanvalkoinen / PVC	5539117	2153 98 4	311	1156040
2078 M10 2M G	M10 10/ St / G	5123583	3141 14 0	386		2953 B M32 LGR	M32 vaaleanharmaa / PVC	5510253	2153 87 0	311	1156048
2078 M10 3M G	M10 10/ St / G	5895152	3141 23 3	386		2953 B M32 RW	M32 puhtaanvalkoinen / PVC	5539179	2153 98 6	311	1156042
2078 M10 VA	M10 10/ V2A	5023579	3141 31 2	386		2953 M M16 LGR	M16 vaaleanharmaa / PVC	5509950	2153 82 9	311	1156028
2078 M12 1M G	M12 12/ St / G	5253457	3141 30 6	386		2953 M M16 RW	M16 puhtaanvalkoinen / PVC	5538752	2153 97 1	311	1156020
2078 M12 2M G	M12 12/ St / G	5123644	3141 14 4	386		2953 M M20 LGR	M20 vaaleanharmaa / PVC	5469391	2153 83 1	311	1156030
2078 M12 VA	M12 12/ V2A	5594437	3141 31 4	386		2953 M M20 RW	M20 puhtaanvalkoinen / PVC	5538813	2153 97 3	311	1156022
2078 M6 1M G	M6 6/ St / G	5253211	3141 04 7	386		2953 M M25 LGR	M25 vaaleanharmaa / PVC	5510017	2153 83 3	311	1156032
2078 M8 1M G	M8 8/ St / G	5253334	3141 12 8	386		2953 M M25 RW	M25 puhtaanvalkoinen / PVC	5538875	2153 97 5	311	1156024
2078 M8 2M G	M8 8/ St / G	5119982	3141 13 6	386		2953 M M32 LGR	M32 vaaleanharmaa / PVC	5510079	2153 83 5	311	1156034
2078 M8 3M G	M8 8/ St / G	5374671	3141 13 8	386		2953 M M32 RW	M32 puhtaanvalkoinen / PVC	5538936	2153 97 7	311	1156026
2078 M8 VA	M8 8/ V2A	5023456	3141 31 0	386							
						2953 M16 LGR	M16 vaaleanharmaa / PVC	5028093	2153 90 4	311	1156011
2081 K M6	M6 1,6/ St / G	5305958	3460 06 1	387		2953 M16 RW	M16 puhtaanvalkoinen / PVC	5538578	2153 96 0	311	1156010
2081 M6 G	M6 1,35/ St / G	5306078	3460 16 9	387		2953 M20 LGR	M20 vaaleanharmaa / PVC	5027799	2153 91 2	311	1156013
						2953 M20 RW	M20 puhtaanvalkoinen / PVC	5538639	2153 96 3	311	1156012
2083 M6 G	M6 4,5/ St / G	5306498	3462 06 4	387		2953 M25 LGR	M25 vaaleanharmaa / PVC	5025214	2153 92 0	311	1156015
2083 M8 G	M8 5,5/ St / G	5306559	3462 08 0	387		2953 M25 RW	M25 puhtaanvalkoinen / PVC	5531739	2153 96 6	311	1156014
						2953 M32 LGR	M32 vaaleanharmaa / PVC	5025153	2153 93 9	311	1156019
2084 K M6	M6 1,15/ Zn / G	5307150	3463 06 0	388		2953 M32 RW	M32 puhtaanvalkoinen / PVC	5538691	2153 96 9	311	1156018
2084 M6 G	M6 1,15/ Zn / G	5307211	3463 56 7	388							
2084 M8 G	M8 1,15/ Zn / G	5307273	3463 58 3	388							
						2953 T M16 LGR	M16 vaaleanharmaa / PVC	5510314	2153 87 2	312	1156058
						2953 T M16 RW	M16 puhtaanvalkoinen / PVC	5539230	2153 99 2	312	1156050
2085 M6 G	M6 1,1/ Zn / G	5307334	3464 06 7	388		2953 T M20 LGR	M20 vaaleanharmaa / PVC	5469575	2153 87 4	312	1156060
2085 M8 G	M8 1,1/ Zn / G	5307396	3464 08 3	388		2953 T M20 RW	M20 puhtaanvalkoinen / PVC	5539292	2153 99 4	312	1156052
						2953 T M25 LGR	M25 vaaleanharmaa / PVC	5510376	2153 87 6	312	1156062
						2953 T M25 RW	M25 puhtaanvalkoinen / PVC	5539599	2153 99 6	312	1156054
2100 FT	/ St / FT	5047773	1120 20 4	333	1463210	2953 T M32 LGR	M32 vaaleanharmaa / PVC	5510437	2153 87 8	312	1156064
2110 FT	/ St / FT	5048732	1121 22 7	333	1463211	2953 T M32 RW	M32 puhtaanvalkoinen / PVC	5539650	2153 99 8	312	1156056
						2954 M16 LGR	M16 vaaleanharmaa / PVC	5482895	2154 50 1	312	1339916
						2954 M20 LGR	M20 vaaleanharmaa / PVC	5483014	2154 52 8	312	1339920
						2954 M25 LGR	M25 vaaleanharmaa / PVC	5483076	2154 53 6	312	1339925
2392	vaaleanharmaa / PA/GF	6027132	6024 00 9	193		2954 M32 LGR	M32 vaaleanharmaa / PVC	5483137	2154 54 4	312	1339932
2393 UP	vaaleanharmaa / PA	6027439	6024 10 6	192		2955 F M16 RW	M16 puhtaanvalkoinen / PP	5585671	2149 35 1	258	1317336
						2955 F M16 STGR	M16 kivenharmaa / PP	5584353	2149 30 3	258	
						2955 F M20 RW	M20 puhtaanvalkoinen / PP	5586036	2149 35 7	258	1317340
						2955 F M20 STGR	M20 kivenharmaa / PP	5585251	2149 30 9	258	
2900 13-16 G	13,5-16 M 16/ St / G	5121336	1383 09 4	282		2955 F M25 RW	M25 puhtaanvalkoinen / PP	5586159	2149 36 3	258	1317345
2900 16-19 G	16,5-19 Pg 11/ St / G	5121398	1383 11 6	282		2955 F M25 STGR	M25 kivenharmaa / PP	5585312	2149 31 5	258	
2900 18-21 G	18-21 M 20/ St / G	5121459	1383 13 2	282		2955 F M32 RW	M32 puhtaanvalkoinen / PP	5586395	2149 36 9	258	1317352
2900 19-23 G	19-23 PG 16/ St / G	5121510	1383 16 7	282		2955 F M32 STGR	M32 kivenharmaa / PP	5585435	2149 32 1	258	
2900 24-29 G	24-29 M 25/ St / G	5121572	1383 21 3	282		2955 F M40 RW	M40 puhtaanvalkoinen / PP	5586456	2149 37 5	258	1317384
2900 30-34 G	33-38 Pg 29/ St / G	5121633	1383 29 9	282		2955 F M40 STGR	M40 kivenharmaa / PP	5585497	2149 32 7	258	
2900 33-38 G	30-34 M 32/ St / G	5569176	1383 31 0	282		2955 F M50 RW	M50 puhtaanvalkoinen / PP	5587835	2149 38 1	258	1317385
2900 39-42 G	39-42 M 40/ St / G	5569237	1383 41 8	282		2955 F M50 STGR	M50 kivenharmaa / PP	5585558	2149 33 3	258	
2900 43-48 G	43-48 Pg 36/ St / G	5121695	1383 36 1	282		2955 F M63 STGR	M63 kivenharmaa / PP	5585619	2149 33 9	258	
2900 49-55 G	49-55 M 50/ St / G	5121756	1383 42 6	282		2955 M16	M16 vaaleanharmaa / PP	5583219	2149 00 4	258	1317356
2900 54-60 G	54-60 Pg 48/ St / G	5121817	1383 48 5	282		2955 M16 SW	M16 syvänmusta / PP	5616276	2149 55 9	258	
2900 61-64 G	61-64 M 63/ St / G	5569299	1383 50 7	282		2955 M20	M20 vaaleanharmaa / PP	5583936	2149 01 0	258	1317360
2900 W 13.5 FT	12,5-13,5 1 1/4" St / FT	5122838	1385 00 3	282		2955 M20 SW	M20 syvänmusta / PP	5616337	2149 56 3	258	
2900 W 139 FT SO	130-140 5" St / FT	5544937	1388 42 8	283		2955 M25	M25 vaaleanharmaa / PP	5583998	2149 01 6	258	1317365
2900 W 17 FT	16-17 3/8" St / FT	5123675	1387 01 4	283		2955 M25 SW	M25 syvänmusta / PP	5616399	2149 56 7	258	
2900 W 17 FT	16-17 3/8" St / FT	5122890	1385 01 1	282		2955 M32	M32 vaaleanharmaa / PP	5584056	2149 02 2	258	1317372
2900 W 21.5 FT	19-21,5 1/2" St / FT	5124450	1388 03 7	283		2955 M32 SW	M32 syvänmusta / PP	5616450	2149 57 1	258	
2900 W 21.5 FT	19-21,5 1/2" St / FT	5123736	1387 03 0	283		2955 M40	M40 vaaleanharmaa / PP	5584292	2149 02 8	258	1317374
2900 W 21.5 FT	19-21,5 1/2" St / FT	5122951	1385 03 8	282		2955 M40 SW	M40 syvänmusta / PP	5616511	2149 57 5	258	
2900 W 27 FT	24,5-27 3/4" St / FT	5124511	1388 05 3	283		2955 M50	M50 vaaleanharmaa / PP	5588191	2149 03 4	258	1317375
2900 W 27 FT	24,5-27 3/4" St / FT	5123798	1387 05 7	283		2955 M50 SW	M50 syvänmusta / PP	5616993	2149 57 9	258	
2900 W 27 FT	24,5-27 3/4" St / FT	5123019	1385 05 4	282		2955 M63	M63 vaaleanharmaa / PP	5588252	2149 04 0	258	1317376
2900 W 33.5 FT	30,5-33,5 1" St / FT	5124573	1388 06 1	283		2955 M63 SW	M63 syvänmusta / PP	5617051	2149 58 3	258	
2900 W 33.5 FT	30,5-33,5 1" St / FT	5123859	1387 06 5	283							
2900 W 33.5 FT	30,5-33,5 1" St / FT	5123071	1385 06 2	282							
2900 W 42.5 FT	39,5-42,5 1 1/4" St / FT	5123910	1387 08 1	283		2960 11 M6 LGR	9-11 vaaleanharmaa / PS	5196990	2130 11 4	268	
2900 W 42.5 FT	39,5-42,5 1 1/4" St / FT	5123132	1385 08 9	282		2960 12 M6 LGR	12-13 vaaleanharmaa / PS	5197058	2130 12 2	268	
2900 W 48.5 FT	45,5-48,5 1 1/2" St / FT	5124696	1388 11 8	283		2960 15 M6 LGR	15-17 vaaleanharmaa / PS	5197119	2130 15 7	268	
2900 W 48.5 FT	45,5-48,5 1 1/2" St / FT	5123972	1387 11 1	283		2960 18 M6 LGR	16,5-18 vaaleanharmaa / PS	5197171	2130 18 1	268	
2900 W 48.5 FT	45,5-48,5 1 1/2" St / FT	5123194	1385 11 9	282		2960 22 M6 LGR	20,5-22 vaaleanharmaa / PS	5197232	2130 21 1	268	
2900 W 54 FT	51-54 1 3/4" St / FT	5123255	1385 12 7	282		2960 25 M6 LGR	22,5-25 vaaleanharmaa / PS	5197294	2130 25 4	268	
2900 W 60 FT	56-60 2" St / FT	5124757	1388 13 4	283		2960 28 M6 LGR	25,5-28 vaaleanharmaa / PS	5197355	2130 28 9	268	
2900 W 60 FT	56-60 2" St / FT	5124030	1387 13 8	283		2960 35 M6 LGR	31,5-35 vaaleanharmaa / PS	5197416	2130 35 1	268	
2900 W 60 FT	56-60 2" St / FT	5123316	1385 13 5	282		2960 40 M6 LGR	36,5-40 vaaleanharmaa / PS	5197478	2130 40 8	268	
2900 W 75 FT SO	71,5-75,5 2 1/2" St / FT	5544814	1388 37 1	283		2960 43 M6 LGR	40,5-43 vaaleanharmaa / PS	5197539	2130 43 2	268	
2900 W 75.5 FT	71,5-75,5 2 1/2" St / FT	5124092	1387 15 4	283		2960 47 M6 LGR	45,5-47 vaaleanharmaa / PS	5197591	2130 47 5	268	
2900 W 88 FT	83-88 3" St / FT	5124153	1387 17 0	283		2960 54 M6 LGR	50,5-54 vaaleanharmaa / PS	5197652	2130 54 8	268	
2900 W 88 FT SO	83-88 3" St / FT	5544876	1388 39 8	283							
						2962 10 LGR	10 vaaleanharmaa / PP	5199090	2140 10 1	269	1339442
						2962 12 LGR	12 vaaleanharmaa / PP	5199151	2140 12 8	269	1339443
						2962 15 LGR	14-15 vaaleanharmaa / PP	5199212	2140 15 2	269	1339444
						2962 18 LGR	16-18 vaaleanharmaa / PP	5199274	2140 18 7	269	1339445
2953 B M16 LGR	M16 vaaleanharmaa / PVC	5510130	2153 86 4	311	1156044	2962 22 LGR	19-22 vaaleanharmaa / PP	5199335	2140 23 3	269	1339446
2953 B M16 RW	M16 puhtaanvalkoinen / PVC	5538998	2153 98 0	311	1156036	2962 28 LGR	25-28				

Tyyppiluettelo

EAN-numeron rakenne: maatumnus 40 valmistajan tunnus 1219 (tuotenumeroille, jotka alkavat numerolla 0 pätee: 1010)

yksilöllinen EAN-C 5647589

Tyyppi	Mitat/väri/eril.	EAN-C.	Tuoteno	Side	FI-nr.	Tyyppi	Mitat/väri/eril.	EAN-C.	Tuoteno	Side	FI-nr.
2962 2x16	15/16 + 15/16 vaaleanharmaa / PP	5199939	2140 68 3	270	1339456	4040	27-12 / PP	5213611	2215 31 4	271	
2962 2x22	18/22 + 18/22 vaaleanharmaa / PP	5199991	2140 72 1	270	1339457	4040 SP	27-12 / PP	5599838	2214 88 1	271	
2962 35 LGR	32-35 vaaleanharmaa / PP	5199458	2140 35 7	269	1339448						
2962 42 LGR	40-42 vaaleanharmaa / PP	5199519	2140 41 1	269	1339449	4041	210-14 / PP	5213796	2215 34 9	271	
2962 6 LGR	6 vaaleanharmaa / PP	5198970	2140 06 3	269	1339440						
2962 8 LGR	8 vaaleanharmaa / PP	5199038	2140 07 1	269	1339441	4042	214-17 / PP	5213673	2215 32 2	271	
						4043	217-21 / PP	5213734	2215 33 0	271	
2985 SW		5230113	2357 05 4	283		4044	221-25 / PP	5213857	2215 35 7	271	
2989 M6 G	M6 1,5 / St / G	5306191	3460 76 2	388							
2989 M8 G	M8 1,5 / St / G	5306252	3460 78 9	388		4758 3.5x15	153,5 / St / GGP	5274759	3195 00 7	389	
						4758 3.5x20	203,5 / St / GGP	5274810	3195 01 5	389	
2990 M6 G	M6 3,5 / St / G	5306979	3462 86 2	388		4758 3.5x25	253,5 / St / GGP	5274872	3195 02 3	389	
2990 M8 G	M8 3,5 / St / G	5307037	3462 88 9	388		4758 3.5x30	303,5 / St / GGP	5274933	3195 03 1	389	
						4758 3.5x35	353,5 / St / GGP	5274995	3195 05 8	389	
3015 12 LGR	6-12 M4 x 22 / PS	5206897	2157 12 8	269		4758 3.5x40	403,5 / St / GGP	5275053	3195 06 6	389	
3015 17 LGR	10-17 M4 x 25 / PS	5206958	2157 17 9	269		4758 3.5x45	453,5 / St / GGP	5275114	3195 07 4	389	
3015 24 LGR	17-24 M4 x 30 / PS	5207016	2157 24 1	269		4758 3.5x50	503,5 / St / GGP	5275176	3195 08 2	389	
3015 34 LGR	24-34 M5 x 35 / PS	5207078	2157 34 9	269		4758 4.5x25	254,5 / St / GGP	5275718	3195 42 2	389	
						4758 4.5x30	304,5 / St / GGP	5275770	3195 43 0	389	
3019 M6 LGR	6-12 M4 x 22 / PS	5207139	2158 12 4	269		4758 4.5x35	354,5 / St / GGP	5275831	3195 44 9	389	
						4758 4.5x40	404,5 / St / GGP	5275893	3195 45 7	389	
3020 LGR	10-17 M4 x 25 / PS	5207191	2158 17 5	269		4758 4.5x45	454,5 / St / GGP	5275954	3195 46 5	389	
						4758 4.5x50	504,5 / St / GGP	5276012	3195 47 3	389	
3021 LGR	17-24 M4 x 30 / PS	5207252	2158 24 8	269		4758 4X15	154 / St / GGP	5275237	3195 20 1	389	
						4758 4X20	204 / St / GGP	5275299	3195 22 8	389	
3022 LGR	24-34 M5 x 35 / PS	5207313	2158 34 5	269		4758 4X25	254 / St / GGP	5275350	3195 23 6	389	
						4758 4X30	304 / St / GGP	5275411	3195 24 4	389	
3030 2	7-11 vaaleanharmaa / PS	5213017	2213 11 7	271		4758 4X35	354 / St / GGP	5275473	3195 25 2	389	
						4758 4X40	404 / St / GGP	5275534	3195 26 0	389	
3040 2	6-16 vaaleanharmaa / PS	5195610	2107 01 5	267		4758 4X45	454 / St / GGP	5275596	3195 27 9	389	
3040 3	6-16 vaaleanharmaa / PS	5195795	2109 01 8	267		4758 4X50	504 / St / GGP	5275657	3195 28 7	389	
3040 LGR	6-16 vaaleanharmaa / PS	5195436	2105 01 2	267		4758 5X30	305 / St / GGP	5276074	3195 63 5	389	
						4758 5X35	355 / St / GGP	5276135	3195 64 3	389	
3041 2	16-24 vaaleanharmaa / PS	5195672	2107 03 1	267		4758 5X40	405 / St / GGP	5276197	3195 65 1	389	
3041 LGR	16-24 vaaleanharmaa / PS	5195498	2105 03 9	267		4758 5X45	455 / St / GGP	5276258	3195 67 8	389	
						4758 5X50	505 / St / GGP	5276319	3195 68 6	389	
3042 LGR	24-34 vaaleanharmaa / PS	5195559	2105 05 5	267		4758 5X60	605 / St / GGP	5321019	3195 69 4	389	
						4758 6X30	306 / St / GGP	5682875	3195 91 0	389	
3050 2 6-16	6-16 vaaleanharmaa / PS	5196211	2115 01 8	266		4758 6X40	406 / St / GGP	5682813	3195 92 9	389	
3050 2 6-16	6-16 vaaleanharmaa / PS	5196211	2115 01 8	266		4758 6X50	506 / St / GGP	5682752	3195 93 7	389	
3050 LGR	6-16 vaaleanharmaa / PS	5195252	2101 01 7	266		4758 6X60	606 / St / GGP	5682691	3195 94 5	389	
						4758T 3.5x15	153,5 / St / GGP	5552017	3198 01 6	389	
3051 LGR	14-24 vaaleanharmaa / PS	5195313	2101 03 3	266		4758T 3.5x20	203,5 / St / GGP	5552079	3198 01 8	389	
						4758T 3.5x25	253,5 / St / GGP	5552130	3198 02 0	389	
3052 LGR	24-34 vaaleanharmaa / PS	5195375	2101 06 8	266		4758T 3.5x30	303,5 / St / GGP	5552192	3198 02 2	389	
						4758T 3.5x35	353,5 / St / GGP	5552253	3198 02 4	389	
3079 LGR	5-14 M5 x 14 / PS	5196570	2124 14 9	267		4758T 3.5x40	403,5 / St / GGP	5552314	3198 02 6	389	
						4758T 4.0x15	154 / St / GGP	5552376	3198 03 0	389	
3080 2 LGR	6-17 M6 x 18 / PS	5196877	2124 49 1	268		4758T 4.0x20	204 / St / GGP	5552437	3198 03 2	389	
3080 LGR	6-17 M6 x 18 / PS	5196631	2124 17 3	267		4758T 4.0x25	254 / St / GGP	5555438	3198 03 4	389	
						4758T 4.0x30	304 / St / GGP	5555551	3198 03 6	389	
3081 LGR	15-25 M8 x 23 / PS	5196693	2124 25 4	267		4758T 4.0x35	354 / St / GGP	5557111	3198 03 8	389	
						4758T 4.0x40	404 / St / GGP	5557418	3198 04 0	389	
3082 LGR	24-34 M8 x 23 / PS	5196754	2124 34 3	267	1339435	4758T 4.0x45	454 / St / GGP	5558132	3198 04 2	389	
						4758T 4.0x50	504 / St / GGP	5558378	3198 04 4	389	
3083 LGR	32-45 M8 x 40 / UF	5196815	2124 45 9	268		4758T 4.5x30	304,5 / St / GGP	5558491	3198 05 4	389	
						4758T 4.5x35	354,5 / St / GGP	5558972	3198 05 6	389	
3100 M6 G	M6 8 / St / G	5250272	3131 06 8	386		4758T 4.5x40	404,5 / St / GGP	5559030	3198 05 8	389	
3100 M8 G	M8 10 / St / G	5250333	3131 08 4	386		4758T 4.5x45	454,5 / St / GGP	5560296	3198 06 0	389	
						4758T 4.5x50	504,5 / St / GGP	5560357	3198 06 2	389	
4014 G	M4 / St / G	5052579	1137 22 0	341	1463220	4758T 5.0x30	305 / St / GGP	5628750	3198 07 3	389	
4014 N G	M4 / St / G	5052517	1137 21 2	341		4758T 5.0x35	355 / St / GGP	5628873	3198 07 5	389	
4014 N M.S. G	M4 / St / G	5052395	1137 01 8	341	1464267	4758T 5.0x40	405 / St / GGP	5628996	3198 07 7	389	
						4758T 5.0x45	455 / St / GGP	5785835	3198 07 9	389	
4021 K 6-13	6-13 4-9 / St / FS	5224419	2307 61 8	299		4758T 5.0x50	505 / St / GGP	5785897	3198 08 1	389	
4021 K 9-16	9-16 4-9 / St / FS	5224471	2307 63 4	299							
						4759 3.5x25	253,5 / St / GGP	5271932	3192 11 3	390	1339529
4024 16-23	16-23 5-10 / PS	5224358	2305 23 2	298		4759 3.5x30	303,5 / St / GGP	5271994	3192 12 1	390	1339530
4024 9-16	9-16 3-8 / PS	5224297	2305 15 1	298		4759 3.5x35	353,5 / St / GGP	5272052	3192 14 8	390	1339531
						4759 3.5x40	403,5 / St / GGP	5272113	3192 15 6	390	1339532
4028	2-4 vaaleanharmaa / PP	5213130	2215 04 7	271		4759 3.5x45	453,5 / St / GGP	5272175	3192 16 4	390	1339533
						4759 3.5x50	503,5 / St / GGP	5272236	3192 17 2	390	1339534
4029	4-7 vaaleanharmaa / PP	5213192	2215 07 1	271		4759 4.5x30	304,5 / St / GGP	5272717	3192 33 4	390	1339542
						4759 4.5x35	354,5 / St / GGP	5272779	3192 34 2	390	1339543
4030	7-11 vaaleanharmaa / PP	5213253	2215 10 1	271		4759 4.5x40	404,5 / St / GGP	5272830	3192 35 0	390	1339544
						4759 4.5x45	454,5 / St / GGP	5272892	3192 36 9	390	1339545
4031 10-14	10-14 vaaleanharmaa / PP	5213314	2215 14 4	271		4759 4.5x50	504,5 / St / GGP	5272953	3192 37 7	390	1339546
4031 14-17	14-17 vaaleanharmaa / PP	5213376	2215 17 9	271		4759 4X25	254 / St / GGP	5272298	3192 21 0	390	1339535
						4759 4X30	304 / St / GGP	5272359	3192 22 9	390	1339536
4032	16-20 vaaleanharmaa / PP	5213437	2215 20 9	271		4759 4X35	354 / St / GGP	5272410	3192 23 7	390	1339537
						4759 4X40	404 / St / GGP	5272472	3192 24 5	390	1339538
4039	24-7 / PP	5213550	2215 30 6	271		4759 4X45	454 / St / GGP	5272533	3192 25 3	390	1339539
4039 SP	24-7 / PP	5599777	2214 87 3	271		4759 4X50	504 / St / GGP	5272595	3192 26 1	390	1339540

01 VBS Katalog 2010_Neuer_Stand / fi / 23/11/2011 (LLExport_01071)

Tyyppi	Mitat/väri/eril.	EAN-C.	Tuoteno	Side	Fl-nr.	Tyyppi	Mitat/väri/eril.	EAN-C.	Tuoteno	Side	Fl-nr.
4759 5X30	305/ St / GGP	5273011	3192 41 5	390	1339547	5024 M10x30 G	M1030/ St / G	5059714	1154 41 9	344	1463243
4759 5X35	355/ St / GGP	5273073	3192 42 3	390	1339548	5024 M10x35 G	M1035/ St / G	5059776	1154 42 7	344	1463244
4759 5X40	405/ St / GGP	5273134	3192 43 1	390	1339549	5024 M10x40 G	M1040/ St / G	5059837	1154 43 5	344	1463245
4759 5X45	455/ St / GGP	5273196	3192 45 8	390	1339550	5024 M12x30 G	M1230/ St / G	5060017	1154 60 5	344	1463246
4759 5X50	505/ St / GGP	5273257	3192 46 6	390	1339551	5024 M12x35 G	M1235/ St / G	5060079	1154 61 3	344	1463247
4759 6X40	406/ St / GGP	5682578	3192 62 8	390	1339553	5024 M12x40 G	M1240/ St / G	5060130	1154 62 1	344	1463248
4759 6X50	506/ St / GGP	5682516	3192 63 6	390	1339554	5024 M12x50 G	M1250/ St / G	5060192	1154 64 8	344	1463249
4759 6X60	606/ St / GGP	5682455	3192 64 4	390	1339555	5024 M6x30 FT	M630/ St / FT	5483694	1154 40 3	344	
4759T 3.0x15	153/ St / GGP	5797593	3198 19 3	390							
4759T 3.0x25	253/ St / GGP	5797777	3198 19 7	390		5026 M6x20 G	M620/ St / G	5057970	1151 70 3	323	
4759T 3.0x30	303/ St / GGP	5797951	3198 19 9	390		5026 M6x20 G	M620/ St / G	5057970	1151 70 3	344	
4759T 3.5x15	153,5/ St / GGP	5560470	3198 21 9	390		5026 M8x25 G	M825/ St / G	5058038	1151 71 1	323	
4759T 3.5x20	203,5/ St / GGP	5560531	3198 22 1	390		5026 M8x25 G	M825/ St / G	5058038	1151 71 1	344	
4759T 3.5x25	253,5/ St / GGP	5561132	3198 22 3	390							
4759T 3.5x30	303,5/ St / GGP	5561378	3198 22 5	390							
4759T 3.5x35	353,5/ St / GGP	5561439	3198 22 7	390							
4759T 3.5x40	403,5/ St / GGP	5561552	3198 22 9	390		5050 20x1.5 BK	20 x 1,5 200/ St	5549079	1465 60 0	296	
4759T 3.5x50	503,5/ St / GGP	5561972	3198 23 1	390		5050 20X3 3M FT	20 x 3/ St / FT	5137597	1465 76 7	296	
4759T 4.0x15	154/ St / GGP	5785958	3198 23 7	390		5050 25X3 3MFT	25 x 3/ St / FT	5137658	1465 77 5	296	
4759T 4.0x20	204/ St / GGP	5562511	3198 23 9	390		5050 25X3 FT	25 x 3 120/ St / FT	5136811	1465 10 4	296	
4759T 4.0x25	254/ St / GGP	5562573	3198 24 1	390		5050 30X3 3M FT	30 x 3/ St / FT	5137719	1465 79 1	296	
4759T 4.0x30	304/ St / GGP	5563112	3198 24 3	390		5050 30X3 FT	30 x 3 120/ St / FT	5136934	1465 14 7	296	
4759T 4.0x35	354/ St / GGP	5786016	3198 24 5	390		5050 30X4 3M FT	30 x 4/ St / FT	5137771	1465 80 5	296	
4759T 4.0x40	404/ St / GGP	5786078	3198 24 7	390		5050 30X4 FT	30 x 4 100/ St / FT	5136996	1465 16 3	296	
4759T 4.0x45	454/ St / GGP	5787457	3198 24 9	390		5050 40X4 3M FT	40 x 4/ St / FT	5137832	1465 82 1	296	
4759T 4.0x50	504/ St / GGP	5787877	3198 25 1	390		5050 40X4 FT	40 x 4 80/ St / FT	5137054	1465 19 8	296	
4759T 4.5x30	304,5/ St / GGP	5790037	3198 26 0	390		5050 SB30x3 FT	30 x 3/ St / FT	5137955	1466 26 7	296	
4759T 4.5x35	354,5/ St / GGP	5791232	3198 26 2	390							
4759T 4.5x40	404,5/ St / GGP	5791294	3198 26 4	390		5055 I FS	12 x 1/ St / FS	5138310	1470 12 4	300	
4759T 4.5x45	454,5/ St / GGP	5791539	3198 26 6	390		5055 II FS	17 x 1/ St / FS	5138372	1470 17 5	300	
4759T 4.5x50	504,5/ St / GGP	5791713	3198 26 8	390		5055 III FS	26 x 1,2/ St / FS	5138433	1470 26 4	300	
4759T 5.0x30	305/ St / GGP	5792192	3198 27 6	390		5055 L I 12	12 x 0,75/ St / FS	5138679	1471 12 0	300	1317459
4759T 5.0x35	355/ St / GGP	5792253	3198 27 8	390		5055 L II 17	17 x 0,75/ St / FS	5138730	1471 17 1	300	
4759T 5.0x40	405/ St / GGP	5792437	3198 28 0	390		5055 L III 26	26 x 1/ St / FS	5138792	1471 26 0	300	
4759T 5.0x45	455/ St / GGP	5792499	3198 28 2	390		5055 L PE I 14	13 x 3/ St / FS	5139393	1473 22 0	300	
4759T 5.0x50	505/ St / GGP	5792550	3198 28 4	390		5055 L PE II 19	19 x 3/ St / FS	5139454	1473 27 1	300	
						5055 L PE III 28	28 x 3,7/ St / FS	5139515	1473 36 0	300	
5015 M5 OS G	M5/ St / G	5053118	1141 05 8	341	1339483	5062 I FS	12 x 1/ St / FS	5139935	1475 12 6	300	
5015 M6 OS G	M6/ St / G	5053170	1141 06 6	341	1339484	5062 II FS	17 x 1/ St / FS	5139997	1475 17 7	300	
5015 M6 OS VA	M6/ V2A	5053231	1141 10 4	341		5062 III FS	26 x 1,2/ St / FS	5140054	1475 26 6	300	
5016 M5 OS G	M5/ St / G	5053293	1142 05 4	342		5062 L I 12	12 x 0,75/ St / FS	5140115	1475 62 2	300	
5016 M6 OS G	M6/ St / G	5053354	1142 06 2	342		5062 L II 17	17 x 0,75/ St / FS	5140177	1475 67 3	300	
						5062 L III 26	26 x 1/ St / FS	5140238	1475 76 2	300	
5017 M10 OS VA	M10/ V4A	5086017	1143 12 7	342							
5017 M6 OS G	M6/ St / G	5053415	1143 06 9	342		7901 5 G	54000/ St / G	5134831	1435 01 9	290	
5017 M6 OS VA	M6/ V4A	5119920	1143 12 3	342		7901 6.5 G	6,54000/ St / G	5134893	1435 02 7	290	
5017 M8 OS VA	M8/ V4A	5085980	1143 12 5	342							
						7902 6 G	6,54000/ St / G	5134954	1436 01 5	291	
5019 M10 OS G	M10 10/ St / G	5053835	1144 13 8	324		7902 8 G	85000/ St / G	5135012	1436 02 3	291	
5019 M10 OS G	M10 10/ St / G	5053835	1144 13 8	342							
5019 M6 OS G	M6 6/ St / G	5053712	1144 10 3	324	1464234	7903 6 G	64000/ St / G	5135074	1437 00 3	291	
5019 M6 OS G	M6 6/ St / G	5053712	1144 10 3	342	1464234	7903 8 G	84000/ St / G	5135135	1437 01 1	291	
5019 M8 OS G	M8 8/ St / G	5053774	1144 11 1	324	1464233	7903 9 G	94000/ St / G	5135197	1437 03 8	291	
5019 M8 OS G	M8 8/ St / G	5053774	1144 11 1	342	1464233						
						7904 6 G	64800/ St / G	5135258	1438 01 8	291	
5020 M10x40 FT	M1040/ St / FT	5056171	1149 45 8	343							
5020 M6X20 FT	M620/ St / FT	5055457	1149 00 8	343	1339485	7905 5 G	53600/ St / G	5135319	1439 01 4	291	
5020 M6X25 FT	M625/ St / FT	5055518	1149 01 6	343	1339486						
5020 M8X25 FT	M825/ St / FT	5055754	1149 21 0	343	1339489	7908 11 G	112400/ St / G	5135555	1442 01 5	291	
5021 M10x40 FT	M1040/ St / FT	5056959	1150 45 6	343							
5021 M6X25 FT	M625/ St / FT	5056232	1150 01 4	343	1339491	7909 6 G	64000/ St / G	5135616	1443 01 1	291	
5021 M8X20 FT	M820/ St / FT	5056478	1150 20 0	343	1339494						
5021 M8X25 FT	M825/ St / FT	5056539	1150 21 9	343	1339495						
5021 M8X40 FT	M840/ St / FT	5056713	1150 24 3	343	1339497	12005	M12 12/ V2A	6043804	6410 17 0	386	
5022 M10x25 F	M1025/ St / F	5057499	1151 40 1	343	1463229	12005 M10 G	M10 10/ St / G	6202270	6410 10 3	386	1464253
5022 M10x30 F	M1030/ St / F	5057550	1151 42 8	343	1463230	12005 M10 VA4301	M10 10/ V2A	6043682	6410 16 2	386	
5022 M10x40 F	M1040/ St / F	5057673	1151 44 4	343	1463232	12005 M12 G	M12 12/ St / G	6202331	6410 11 1	386	1464254
5022 M12x30 G	M1230/ St / G	5057796	1151 62 2	343	1463233	12005 M8 F	M8 8/ St / G	6202218	6410 08 1	386	1464252
5022 M12x40 G	M1240/ St / G	5057918	1151 64 9	343	1463235	12005 M8 VA4301	M8 8/ V2A	6043569	6410 15 4	386	
5022 M6X25 F	M625/ St / F	5057017	1151 01 0	343	1463221						
5022 M6X30 F	M630/ St / F	5057079	1151 02 9	343	1463222	12400 10x100 G	100 10/ St / G	5867135	3188 30 2	391	
5022 M8X25 F	M825/ St / F	5057253	1151 21 5	343	1463225	12400 10x60 G	60 10/ St / G	5867074	3188 25 6	391	
5022 M8X30 F	M830/ St / F	5057314	1151 22 3	343	1463226	12400 10x70 G	70 10/ St / G	5270430	3188 27 2	391	
5022 M8X40 F	M840/ St / F	5057437	1151 25 8	343	1463228	12400 10x80 G	80 10/ St / G	5270492	3188 28 0	391	
						12400 12x70 G	70 12/ St / G	5270553	3188 36 1	391	
						12400 12x80 G	80 12/ St / G	5270614	3188 38 8	391	
5023 M10x30 G	M1030/ St / G	5058335	1153 41 2	344	1463236	12400 6x40 G	406/ St / G	5866718	3188 04 3	391	
5023 M10x35 G	M1035/ St / G	5058397	1153 42 0	344	1463237	12400 6x50 G	506/ St / G	5270195	3188 05 1	391	
5023 M10x40 G	M1040/ St / G	5058458	1153 43 9	344	1463238	12400 6x60 G	606/ St / G	5270256	3188 07 8	391	
5023 M12x30 G	M1230/ St / G	5058755	1153 61 7	344	1463239	12400 6x80 G	806/ St / G	5866770	3188 09 4	391	
5023 M12x35 G	M1235/ St / G	5058816	1153 62 5	344	1463240	12400 8x100 G	1008/ St / G	5867012	3188 20 5	391	
5023 M12x40 G	M1240/ St / G	5058878	1153 63 3	344	1463241	12400 8x40 G	408/ St / G	5866831	3188 14 0	391	
5023 M12x50 G	M1250/ St / G	5058939	1153 64 1	344	1463242	12400 8x50 G	508/ St / G	5866893	3188 15 9	391	

01 VBS Katalog 2010_Neuer_Stand / fi / 23/11/2011 (LLEExport_01071)

Tyyppiluettelo

EAN-numeron rakenne: maatumnus 40

valmistajan tunnus 1219 (tuotenumeroille, jotka alkavat numerolla 0 pätee: 1010)

yksilöllinen EAN-C 5647589

Tyyppi	Mitat/väri/eril.	EAN-C.	Tuoteno	Side	FI-nr.	Tyyppi	Mitat/väri/eril.	EAN-C.	Tuoteno	Side	FI-nr.
12400 8x60 G	60 8 / St / G	5270317	3188 16 7	391		CPS 4 SK OR	oranssi 300 / PE	5668121	1124 55 3	334	
12400 8x70 G	70 8 / St / G	5270379	3188 17 5	391							
12400 8x80 G	80 8 / St / G	5866954	3188 18 3	391							
						CPS 4 SPR 492 FT	40 x 22,5 / St / FT	6006014	6007 24 4	334	
46277 GTP	/ St / GTP	5044598	1115 33 2	351	1463209	CPS 4 SPR 592 FT	40 x 22,5 / St / FT	6006076	6007 25 2	334	
46277 GPL	/ St / GTP	5044659	1115 35 9	351	1462228	CPS 4 SPR 692 FT	40 x 22,5 / St / FT	6006137	6007 26 0	334	
						CPS 4 SPR 792 FT	40 x 22,5 / St / FT	6006199	6007 27 9	334	
						CPS 4 SPR 892 FT	40 x 22,5 / St / FT	6006250	6007 28 7	334	
						CPS 4 SPR 992 FT	40 x 22,5 / St / FT	6006311	6007 29 5	334	
A 11	vaaleanharmaa / PE	5152170	2000 34 2	164		CPS 4 SPR1092 FT	40 x 22,5 / St / FT	6006373	6007 30 9	334	
A 11 5	vaaleanharmaa / PE	5152057	2000 32 6	164		CPS 4 SPR1192 FT	40 x 22,5 / St / FT	6006434	6007 31 7	334	
A 6	vaaleanharmaa / PP	5249795	2001 05 5	164							
A 8	vaaleanharmaa / PE	5151395	2000 01 6	164		CPS 4L 2M FT	/ St / FT	5050230	1121 97 9	334	1462435
						CPS 4L 2M VA	/ V2A	5050179	1121 96 0	334	
						CPS 4L 6M FT	/ St / FT	5049937	1121 89 8	334	1462436
A 8 5	vaaleanharmaa / PE	5151456	2000 02 4	164		CPS 4L 6M VA	/ V2A	5049999	1121 90 1	334	
A 9	vaaleanharmaa / PE	5151630	2000 09 1	164							
A11 HF RO	punainen / PE	5820390	2000 16 4	164		CPS 5 G 220 FT	/ St / FT	6191710	6349 40 4	335	1462440
A11 HF RW	puhtaavalkoinen / PE	5707899	2000 18 0	164		CPS 5 G 260 FT	/ St / FT	6191772	6349 41 2	335	1462441
						CPS 5 G 260 VA	/ V2A	6192076	6349 81 1	335	
A8 HF RO	punainen / PE	5239598	2000 05 9	164		CPS 5 G 300 FT	/ St / FT	6191833	6349 43 9	335	1462442
A8 HF RW	puhtaavalkoinen / PE	5313090	2000 07 5	164							
						CPS 5 G 340 FT	/ St / FT	6191895	6349 44 7	335	1462443
						CPS 5 G 340 VA	/ V2A	6192199	6349 84 6	335	
B 10 M	vaaleanharmaa / UF	5107651	2002 16 7	182		CPS 5 G 380 FT	/ St / FT	6191956	6349 46 3	335	1462444
B 10 M 5	vaaleanharmaa / UF	5107712	2002 14 0	182		CPS 5 G 380 VA	/ V2A	6192250	6349 85 4	335	
B 100	vaaleanharmaa / UF	5542537	2001 26 8	180	1627118						
B 100 5	vaaleanharmaa / UF	5117735	2001 24 1	180	1627130	CPS 5 L 1.5M FT	/ St / FT	5514572	1121 36 3	334	
B 100 E POR	oranssi 10 / UF	5445791	2002 57 1	184	1627190	CPS 5 L 1M FT	/ St / FT	5886211	1121 44 8	335	
B 11 M	vaaleanharmaa / UF	5105435	2002 34 5	182		CPS 5 L 200 FT	/ St / FT	5745037	1121 39 1	334	
B 11 M 5	vaaleanharmaa / UF	5107590	2002 32 9	182							
						CPS 5 L 2M FT	/ St / FT	5049210	1121 46 4	335	1462437
						CPS 5 L 2M VA	/ V2A	5049272	1121 48 0	335	
B 12 M	vaaleanharmaa / UF	5105312	2002 52 3	182		CPS 5 L 300 FT	/ St / FT	5672975	1121 24 3	334	
B 12 M 5	vaaleanharmaa / UF	5105374	2002 50 7	182							
B 160	vaaleanharmaa / UF	5542414	2001 30 6	180	FI	CPS 5 L 3M FT	/ St / FT	5419686	1121 46 6	335	
B 160 5	vaaleanharmaa / UF	5542476	2001 29 2	180	FI						
B 160 E POR	oranssi 10 / UF	5445807	2002 57 8	184	1627191	CPS 5 L 400 FT	/ St / FT	5672555	1121 27 8	334	
						CPS 5 L 500 FT	/ St / FT	5886334	1121 40 5	334	
						CPS 5 L 600 FT	/ St / FT	5672494	1121 29 4	334	
B 25 M	vaaleanharmaa / UF	5545415	2001 13 6	180		CPS 5 L 6M FT	/ St / FT	5462491	1121 47 2	335	1462438
B 25 M 5	vaaleanharmaa / UF	5125655	2001 12 8	180		CPS 5 L 6M VA	/ V2A	5049333	1121 49 9	335	
B 250	vaaleanharmaa / UF	5542292	2001 34 9	181	1627142						
B 250 5	vaaleanharmaa / UF	5542353	2001 33 0	181	1627150	CPS 5 L 700 FT	/ St / FT	5672616	1121 33 2	334	
B 250 E POR	oranssi 6 / UF	5445845	2002 58 5	184	1627192	CPS 5 L 800 FT	/ St / FT	5882251	1121 30 8	334	
						CPS 5 L 900 FT	/ St / FT	5068310	1121 33 6	334	
B 40 M	vaaleanharmaa / UF	5545170	2001 17 9	180		CPS 5 SK OR	oranssi 200 / PE	5668138	1124 56 1	336	
B 40 M 5	vaaleanharmaa / UF	5545231	2001 16 0	180							
B 60	vaaleanharmaa / UF	5119838	2001 21 7	180		DIN 128 A M10 G	M10 10,5 / St / G	5302414	3405 10 9	392	
B 60 M 5	vaaleanharmaa / UF	5545118	2001 20 9	180		DIN 128 A M12 G	M12 12,5 / St / G	5302476	3405 12 5	392	
						DIN 128 A M6 G	M6 6,3 / St / G	5302292	3405 06 0	392	
B 9 B M	vaaleanharmaa / UF	5536178	2001 63 2	182		DIN 128 A M8 G	M8 8,3 / St / G	5302353	3405 08 7	392	
B 9 B M 5	vaaleanharmaa / UF	5536239	2001 61 6	182		DIN 6798 A M10 G	10,5-18-18 / St / G	5301752	3404 10 2	391	
B 9 K M	vaaleanharmaa / UF	5536116	2001 94 2	182		DIN 6798 A M12 G	13,20,5-20,5 / St / G	5301813	3404 12 9	391	
B 9 T M	vaaleanharmaa / PP	5540076	2001 85 3	167		DIN 6798 A M5 G	5,3 10 / St / G	5301578	3404 05 6	391	
B 9 T M	puna-harmaa / PP	5110477	2001 88 8	167		DIN 6798 A M6 G	6,4 11-11 / St / G	5301639	3404 06 4	391	
B 9 T M 5	vaaleanharmaa / PP	5541936	2001 84 5	167		DIN 6798 A M8 G	8,4 15-15 / St / G	5301691	3404 08 0	391	
B 9 T M NL	vaaleanharmaa / PP	5539896	2001 86 1	167		DIN 934 M10 G	M10 17 / St / G	5298212	3400 10 7	324	
						DIN 934 M10 G	M10 17 / St / G	5298212	3400 10 7	391	
						DIN 934 M10 VA	M10 17 / V2A	5297796	3397 10 6	391	
C30 2M FS	/ St / FS	5042075	1110 00 4	330		DIN 934 M12 G	M12 19 / St / G	5298274	3400 12 3	391	
C30 L 1M FT	/ St / FT	5037934	1109 86 3	330		DIN 934 M12 VA	M12 19 / V2A	5297857	3397 11 4	391	
						DIN 934 M4 G	M4 7 / St / G	5297970	3400 04 2	391	
C30 L 200 FT	/ St / FT	5036975	1109 78 2	330		DIN 934 M5 G	M5 8 / St / G	5298038	3400 05 0	391	
						DIN 934 M6 G	M6 10 / St / G	5298090	3400 06 9	324	
C30 L 2M FS	/ St / FS	5053897	1110 00 2	330		DIN 934 M6 G	M6 10 / St / G	5298090	3400 06 9	391	
C30 L 2M FT	/ St / FT	5041771	1109 87 1	330		DIN 934 M6 VA	M6 10 / V2A	5297673	3397 06 8	391	
						DIN 934 M8 G	M8 13 / St / G	5298151	3400 08 5	324	
C30 L 300 FT	/ St / FT	5037033	1109 79 0	330		DIN 934 M8 G	M8 13 / St / G	5298151	3400 08 5	391	
C30 L 400 FT	/ St / FT	5037095	1109 80 4	330		DIN 934 M8 VA	M8 13 / V2A	5297734	3397 08 4	391	
C30 L 500 FT	/ St / FT	5037156	1109 81 2	330							
C30 L 600 FT	/ St / FT	5037217	1109 82 0	330							
C30 L 700 FT	/ St / FT	5037279	1109 83 9	330							
C30 L 800 FT	/ St / FT	5037330	1109 84 7	330		ECO 12 5	vaaleanharmaa / PP	5507192	2001 00 7	166	
C30 L 900 FT	/ St / FT	5037392	1109 85 5	330		ECO 14 5	vaaleanharmaa / PP	5507673	2001 01 3	166	
						ECO 18 5	vaaleanharmaa / PP	5508458	2001 01 9	166	

01 VBS Katalog 2010_Neuer_Stand / fi / 23/11/2011 (LLExport_01071)

Tyyppi	Mitat/väri/eril.	EAN-C.	Tuoteno	Side	Fl-nr.	Tyyppi	Mitat/väri/eril.	EAN-C.	Tuoteno	Side	Fl-nr.
ECO10	vaaleanharmaa/ PP	5507079	2001 00 0	166		GMH22 M12 VA	M12 12-12 / V4A	5084228	1146 65 2	343	
ECO10 RW	puhtaanvalkoinen/ PP	5532392	2001 03 0	166	1627110	GMH22 M6 G	M6 6-6 / St / G	5054795	1146 60 2	343	
ECO12	vaaleanharmaa/ PP	5507130	2001 00 6	166		GMH22 M6 VA	M6 6-6 / V4A	5084174	1146 64 6	343	
ECO12 RW	puhtaanvalkoinen/ PP	5532453	2001 03 3	166	1627112	GMH22 M8 G	M8 8-8 / St / G	5054856	1146 61 0	343	
ECO14	vaaleanharmaa/ PP	5507253	2001 01 2	166		GMH22 M8 VA	M8 8-8 / V4A	5084181	1146 64 8	343	
ECO14 RW	puhtaanvalkoinen/ PP	5532514	2001 03 6	166	1627114						
ECO18	vaaleanharmaa/ PP	5508212	2001 01 8	166							
ECO18 RW	puhtaanvalkoinen/ PP	5532576	2001 03 9	166	1627152	GMS 1 FS	10/ St / G	5485759	1124 60 3	347	
EDFB M32	M32/ TPE	5651727	2012 70 9	184		GMS 1 FT	10/ St / FT	5486015	1124 64 3	347	
EDFB M40	M40/ TPE	5651734	2012 73 3	184		GMS 2 FS	10/ St / G	5485766	1124 60 5	347	
EDK 25 LGR	M25/ EVA	5246961	2011 63 8	174	1627163	GMS 2 FT	10/ St / FT	5486022	1124 64 5	347	
EDK 25 RW	M25/ EVA	5303206	2011 68 9	174	1627166	GMS 3 FS	10/ St / G	5485803	1124 60 7	347	
EDK 32 LGR	M32/ EVA	5246978	2011 64 6	174	1627164	GMS 3 FT	10/ St / FT	5486039	1124 64 7	347	
EDK 32 RW	M32/ EVA	5303213	2011 69 7	174	1627167	GMS 4 FS	10/ St / G	5485810	1124 60 9	347	
EDK 40 LGR	M40/ EVA	5246985	2011 65 4	174	1627165	GMS 4 FT	10/ St / FT	5486046	1124 64 9	347	
EDK 40 RW	M40/ EVA	5303220	2011 70 0	174	1627168	GMS 4121 FS	10/ St / G	5485971	1124 63 1	348	
EDR 25 16-20 LGR	M25/ PVC	5246909	2011 50 6	174	1627169	GMS 4121 FT	10/ St / FT	5486152	1124 67 1	348	
EDR 25 20-25 LGR	M25/ PVC	5246916	2011 51 4	174	1627170	GMS 4141 FS	10/ St / G	5485988	1124 63 3	348	
EDR 32 20-25 LGR	M32/ PVC	5246923	2011 52 2	174		GMS 4141 FT	10/ St / FT	5486169	1124 67 3	348	
EDR 32 25-32 LGR	M32/ PVC	5246930	2011 53 0	174		GMS 5 FS	10/ St / G	5485827	1124 61 1	347	
EDR 40 25-32 LGR	M40/ PVC	5246947	2011 53 8	174		GMS 5 FT	10/ St / FT	5486053	1124 65 1	347	
EDR 40 32-40 LGR	M40/ PVC	5246954	2011 54 6	174		GMS L 45 FS	10/ St / G	5485957	1124 62 7	348	
EDVS M20 LGR	M 20/ PE	5105251	2012 37 5	168		GMS L 45 FS	10/ St / G	5485964	1124 62 9	348	
EDVS M20 LGR	M 20/ PE	5105251	2012 37 5	181		GMS L 45 FT	10/ St / FT	5486138	1124 66 7	348	
EDVS M25 LGR	M 25/ PE	5105190	2012 38 3	168		GMS L 45 FT	10/ St / FT	5486145	1124 66 9	348	
EDVS M25 LGR	M 25/ PE	5105190	2012 38 3	181		GMS L 90 FS	10/ St / G	5485926	1124 62 1	348	
EDVS M32 LGR	M 32/ PE	5105138	2012 39 1	168		GMS L 90 FS	10/ St / G	5485919	1124 61 9	349	
EDVS M32 LGR	M 32/ PE	5105138	2012 39 1	181		GMS L 90 FS	10/ St / G	5485933	1124 62 3	349	
FAZ II 10 10 GS	M1095/ St / G	5888499	3498 54 9	384		GMS L 90 FS	10/ St / G	5485940	1124 62 5	349	
FAZ II 10 30	M10 115/ St / G	5888550	3498 58 1	384	1462165	GMS L 90 FT	10/ St / FT	5486121	1124 66 5	349	
FAZ II 12 10	M12 110/ St / G	5888611	3498 65 4	384	1462166	GMS L 90 FT	10/ St / FT	5486107	1124 66 1	348	
FAZ II 8 10 GS	M8 77/ St / G	5888437	3498 50 6	384		GMS L 90 FT	10/ St / FT	5486091	1124 65 9	349	
FH II 18X80	M12 120/ St / G	5489139	3498 74 3	384		GMS L 90 FT	10/ St / FT	5486114	1124 66 3	349	
FL 1 TG	0-18 35/ TG / G	5150855	1488 01 5	319	1339801	GMS L FS	10/ St / G	5485865	1124 61 3	347	
FL 2 TG	0-20 42/ TG / G	5150916	1488 02 3	319	1339802	GMS L FT	10/ St / FT	5486060	1124 65 3	347	
FL 3 TG	0-26 54/ TG / G	5150978	1488 03 1	319	1339803	GMS T FS	10/ St / G	5485872	1124 61 5	348	
FL1-G M8 TG	0-18 35/ TG / G	5151036	1488 07 4	319	1339808	GMS T FT	10/ St / FT	5486077	1124 65 5	348	
FL2-G M10 TG	0-20 42/ TG / G	5151098	1488 08 2	319	1339810	GMS X FS	10/ St / G	5485889	1124 61 7	347	
FL3-G M12 TG	0-26 54/ TG / G	5151159	1488 09 0	319	1339812	GMS X FT	10/ St / FT	5486084	1124 65 7	347	
FNA II 6X30 M6/5	M6 6/ St / G	5461890	3498 42 5	384	1462928	GVMS FS	10/ St / G	5485742	1124 60 1	348	
FZEA II 10X40 G	M8 10/ St / G	5454038	3492 03 6	383		GVMS FT	10/ St / FT	5486008	1124 64 1	348	
FZEA II 12X40 G	M10 12/ St / G	5454090	3492 06 0	383		HG 60	oranssi 68/ PP	5032779	2003 41 4	195	1156006
FZEA II 14X40 G	M12 14/ St / G	5454151	3492 09 5	383		HG 60 2	oranssi 100/ PP	5032830	2003 42 2	195	1156007
FZED 10X40 G	5/ St / G	5454212	3492 62 1	384		HG 60 MW	oranssi 68/ PP	5246732	2003 61 1	195	
FZED 12X40 G	5/ St / G	5454274	3492 66 4	384		HG 60-35	oranssi 68/ PP	5051350	2003 42 6	195	
FZED 14X40 G	5/ St / G	5454335	3492 69 9	384		HG 60-35 MW	oranssi 68/ PP	5246725	2003 60 3	195	
FZUB 10X40	10 10/ St	5454397	3492 33 8	383		HGMH18 M10 G	M10 10-10 / St / G	5055150	1146 73 4	342	
FZUB 12X40	12 10/ St	5454458	3492 36 2	383		HGMH18 M12 G	M12 12-12 / St / G	5055211	1146 74 2	342	
FZUB 14X40	14 10/ St	5454519	3492 39 7	383		HGMH18 M6 G	M6 6-6 / St / G	5055037	1146 71 8	342	
GMF22 M10 G	M10 8/ St / G	5445661	1146 45 9	343		HGMH18 M8 G	M8 8-8 / St / G	5055099	1146 72 6	342	
GMF22 M12 G	M12 9,5/ St / G	5445678	1146 46 3	343		HGMH22 M10 G	M10 10-10 / St / G	5055334	1146 81 5	343	
GMF22 M6 G	M6 6/ St / G	5445616	1146 45 1	343		HGMH22 M12 G	M12 12-12 / St / G	5055396	1146 82 3	343	
GMF22 M8 G	M8 6/ St / G	5445623	1146 45 5	343		HGMH22 M8 G	M8 8-8 / St / G	5055273	1146 80 7	343	
GMH18 M10 G	M10 10-10 / St / G	5054672	1146 52 1	342		HG-UPM1	sininen	5406310	6119 95 0	197	
GMH18 M10 VA	M10 10-10 / V4A	5084907	1146 56 0	342		HG-UPM2	sininen	5406327	6119 95 1	197	
GMH18 M12 VA	M12 12-12 / V4A	5084167	1146 56 2	342		HG-UPM3	sininen	5406334	6119 95 2	197	
GMH18 M6 G	M6 6-6 / St / G	5054559	1146 50 5	342		HKF22 M10x30 G	M10 30/ St / G	5445739	1148 96 1	344	
GMH18 M6 VA	M6 6-6 / V4A	5084129	1146 55 6	342		HKF22 M10x50 G	M10 50/ St / G	5445746	1148 96 6	344	
GMH18 M8 G	M8 8-8 / St / G	5054610	1146 51 3	342		HKF22 M12x30 G	M12 30/ St / G	5445784	1148 97 2	344	
GMH18 M8 VA	M8 8-8 / V4A	5084150	1146 55 8	342		HKF22 M8x30 G	M8 30/ St / G	5445685	1148 95 0	344	
GMH22 M10 G	M10 10-10 / St / G	5054917	1146 62 9	343		HKF22 M8x50 G	M8 50/ St / G	5445722	1148 95 5	344	
GMH22 M10 VA	M10 10-10 / V4A	5084211	1146 65 0	343		HMS-KS5X50	5 x 50 50/ St / G	5964100	3498 20 4	385	
GMH22 M12 G	M12 12-12 / St / G	5054979	1146 63 7	343		HTS 35		5477259	1125 03 6	351	1339502
						HV 100 KD	oranssi 50/ PP	5033011	2003 44 9	196	

Tyyppiluettelo

EAN-numeron rakenne: maatumnus 40

valmistajan tunnus 1219 (tuotenumeroille, jotka alkavat numerolla 0 pätee: 1010)

yksilöllinen EAN-C 5647589

Tyyppi	Mitat/väri/eril.	EAN-C.	Tuoteno	Side	FI-nr.	Tyyppi	Mitat/väri/eril.	EAN-C.	Tuoteno	Side	FI-nr.
HV 60	oranssi68/ PP	5032953	2003 44 2	196		MS 21 L 800 FT	/ St / FT	5697749	1122 93 9	336	
						MS 21 L 900 FT	/ St / FT	5697787	1122 94 0	336	
HV 60 MW	oranssi68/ PP	5246749	2003 61 9	196		MS 21 SK OR	oranssi/ PE	5686217	1122 90 2	337	
HV 70 D	oranssi74/ PP	5032892	2003 43 0	196		MS 41 L 1M 2 FS	/ St / FS	5698142	1122 97 0	337	
						MS 41 L 1M 2 FT	/ St / FT	5698081	1122 96 2	338	
						MS 41 L 1M 2 V2A	/ V2A	5698203	1122 97 8	339	
						MS 41 L 1M 2 V4A	/ V4A	5698265	1122 98 8	339	
K-C30 G	0,725/ St / G	5151210	1488 20 1	323		MS 41 L 1M FS	/ St / FS	5697503	1122 90 8	337	
						MS 41 L 1M FT	/ St / FT	5487272	1122 60 6	338	
KD 10 100	M10 100/ St / G	5239352	3482 75 8	383	1339950	MS 41 L 200 FT	/ St / FT	5484516	1122 50 9	338	
KD 10 150	M10 150/ St / G	5239291	3482 76 6	383		MS 41 L 300 FT	/ St / FT	5485896	1122 51 7	338	
KD 8 100	M8 100/ St / G	5239475	3482 70 7	383		MS 41 L 3M 2 FS	/ St / FS	5698159	1122 97 2	337	
						MS 41 L 3M 2 FT	/ St / FT	5698098	1122 96 4	338	
						MS 41 L 3M 2 V2A	/ V2A	5698210	1122 98 0	339	
KL 100	/ MF	5158592	2016 12 5	181	1627174	MS 41 L 3M 2 V4A	/ V4A	5698272	1122 99 0	339	
						MS 41 L 3M FS	/ St / FS	5686224	1122 91 0	337	
						MS 41 L 3M FT	/ St / FT	5487876	1122 62 2	338	
KVM		5577768	2363 01 0	185	5234100	MS 41 L 400 FT	/ St / FT	5486251	1122 52 5	338	
						MS 41 L 500 FT	/ St / FT	5486794	1122 53 3	338	
KVM-M		5686354	2363 01 5	185		MS 41 L 600 FT	/ St / FT	5486916	1122 54 1	338	
KVM-P		5687771	2363 01 9	185		MS 41 L 6M 2 FS	/ St / FS	5698166	1122 97 4	337	
						MS 41 L 6M 2 FT	/ St / FT	5698104	1122 96 6	338	
						MS 41 L 6M 2 V2A	/ V2A	5698227	1122 98 2	339	
MD 5 GTP	530/ St / GTP	5683414	3484 60 2	382		MS 41 L 6M 2 V4A	/ V4A	5698289	1122 99 2	339	
						MS 41 L 6M FS	/ St / FS	5686231	1122 91 2	337	
MD 6 GTP	632/ St / GTP	5683353	3484 62 9	382		MS 41 L 6M FT	/ St / FT	5488170	1122 65 7	338	
MMS10X100	10x100 100/ St / G	5964049	3498 15 8	384		MS 41 L 700 FT	/ St / FT	5487036	1122 56 8	338	
MMS10X80	10 x 80 80/ St / G	5963981	3498 12 3	384	1462167	MS 41 L 800 FT	/ St / FT	5487098	1122 57 6	338	
						MS 41 L 900 FT	/ St / FT	5487159	1122 58 4	338	
MMS6X50	6 x 50 50/ St / GC	5963929	3498 10 7	384	1462927	MS 41 LS 1M 2 FS	/ St / FS	5697923	1123 00 8	338	
						MS 41 LS 1M 2 FT	/ St / FT	5697862	1123 00 1	339	
						MS 41 LS 1M FS	/ St / FS	5697978	1122 48 1	338	
						MS 41 LS 1M FT	/ St / FT	5697961	1122 47 9	339	
						MS 41 LS 3M 2 FS	/ St / FS	5698319	1123 01 0	338	
MP UNI FS	115170/ St / FS	6146895	7084 77 3	174	1464695	MS 41 LS 3M 2 FT	/ St / FT	5697909	1123 00 3	339	
						MS 41 LS 3M FS	/ St / FS	5686248	1122 91 4	338	
MP WI KL. DD	210 120/ St / DD	5163305	7085 11 1	167		MS 41 LS 3M FT	/ St / FT	5050735	1122 48 3	339	
MP WI KL. DD	210 120/ St / DD	5163305	7085 11 1	174		MS 41 LS 6M 2 FS	/ St / FS	5698326	1123 01 2	338	
MP WI KL. FS	210 120/ St / FS	6146833	7084 76 5	167		MS 41 LS 6M 2 FT	/ St / FT	5697916	1123 00 5	339	
MP WI KL. FS	210 120/ St / FS	6146833	7084 76 5	174		MS 41 LS 6M FS	/ St / FS	5686255	1122 91 6	338	
						MS 41 LS 6M FT	/ St / FT	5050742	1122 48 7	339	
MPG 65 FT	8165/ St / FT	6933259	6006 48 6	175	1462325	MS 41 LS1M 2 V2A	/ V2A	5698333	1123 01 4	339	
						MS 41 LS1M 2 V4A	/ V4A	5698395	1123 02 1	340	
						MS 41 LS3M 2 V2A	/ V2A	5698340	1123 01 6	339	
						MS 41 LS3M 2 V4A	/ V4A	5698401	1123 02 3	340	
						MS 41 LS6M 2 V2A	/ V2A	5698388	1123 01 8	339	
						MS 41 LS6M 2 V4A	/ V4A	5698432	1123 02 5	340	
M-Quick 15-19LGR	15-19 / PA	5880936	2153 10 6	259	1339401	MS 41 SK OR	oranssi/ PE	5686200	1122 90 0	340	
M-Quick 18-22LGR	18,5-22,5 / PA	5880998	2153 11 4	259	1339402						
M-Quick 25-28LGR	25-28,5 / PA	5881056	2153 13 0	259	1339403						
M-Quick 31-37LGR	31-37 / PA	5881117	2153 15 7	259	1339404						
M-Quick M20 LGR	16-20 / PA	5742395	2153 71 8	259							
M-Quick M20 SW	16-20 / PA	5505334	2153 78 5	259							
M-Quick M25 LGR	20-25 / PA	5741732	2153 72 6	259							
M-Quick M25 SW	20-25 / PA	5505396	2153 78 7	259							
M-Quick M32 LGR	25-32 / PA	5741671	2153 73 4	259							
M-Quick M32 SW	25-32 / PA	5505457	2153 78 9	259							
						PD-UPM1	punainen	5406266	6119 94 5	194	
						PD-UPM2	punainen	5406297	6119 94 6	194	
						PD-UPM3	punainen	5406303	6119 94 7	194	
MS 21 L 200 FT	/ St / FT	5697626	1122 93 3	336		S 25 ZD	18-25 0,45/ St / ZD	5148210	1486 30 6	319	
MS 21 L 2M FS	/ St / FS	5686262	1122 91 8	336		S 32 ZD	28-32 0,45/ St / ZD	5148272	1486 31 4	319	
MS 21 L 300 FT	/ St / FT	5697664	1122 93 4	336		S 37 ZD	35-37 0,45/ St / ZD	5148333	1486 32 2	319	
MS 21 L 3M FS	/ St / FS	5686279	1122 92 0	336		S16 FT	16 3000/ St / FT	5069270	2047 30 6	304	
MS 21 L 3M FT	/ St / FT	5686293	1122 92 4	336		S16 G	16 3000/ St / G	5246275	2047 30 5	305	
MS 21 L 3M V2A	/ V2A	5697558	1122 92 8	337		S16 SW	16 3000/ St / FSK	5621720	2047 52 0	305	
MS 21 L 3M V4A	/ V4A	5697602	1122 93 1	337		S16 VA	16 3000/ V2A	5622246	2047 65 0	305	
MS 21 L 400 FT	/ St / FT	5697671	1122 93 5	336		S20 FT	20 3000/ St / FT	5069287	2047 30 9	304	
MS 21 L 500 FT	/ St / FT	5697688	1122 93 6	336		S20 G	20 3000/ St / G	5246282	2047 30 8	305	
MS 21 L 600 FT	/ St / FT	5697725	1122 93 7	336		S20 SW	20 3000/ St / FSK	5621737	2047 52 1	305	
						S20 VA	20 3000/ V2A	5622253	2047 65 1	305	
MS 21 L 6M FS	/ St / FS	5686286	1122 92 2	336		S25 FT	25 3000/ St / FT	5069294	2047 31 2	304	
MS 21 L 6M FT	/ St / FT	5686309	1122 92 6	336		S25 G	25 3000/ St / G	5246299	2047 31 1	305	
MS 21 L 6M V2A	/ V2A	5697565	1122 92 9	337							
MS 21 L 6M V4A	/ V4A	5697619	1122 93 2	337							
MS 21 L 700 FT	/ St / FT	5697732	1122 93 8	336							

01 VBS Katalog 2010_Neuer_Stand / fi / 23/11/2011 (LLExport_01071)

Tyyppi	Mitat/väri/eril.	EAN-C.	Tuoteno	Side	FI-nr.	Tyyppi	Mitat/väri/eril.	EAN-C.	Tuoteno	Side	FI-nr.
S25 SW	253000/ St / FSK	5621744	2047 52 2	305		SBM32 VA	M40x1,5245/ V2A	5622642	2047 69 4	306	
S25 VA	253000/ V2A	5622260	2047 65 2	305		SBM40 FT	M40x1,5288/ St / FT	5381297	2047 50 5	305	
						SBM40 G	M40x1,5288/ St / G	5153887	2047 44 4	305	
S32 FT	323000/ St / FT	5069300	2047 31 5	304		SBM40 SW	M50x1,5288/ St / FSK	5622147	2047 56 4	306	
						SBM40 VA	M40x1,5288/ V2A	5622659	2047 69 5	306	
S32 G	323000/ St / G	5246305	2047 31 4	305		SBM50 FT	M50x1,5346/ St / FT	5381303	2047 50 6	305	
S32 SW	323000/ St / FSK	5621751	2047 52 3	305		SBM50 G	M50x1,5346/ St / G	5153894	2047 44 5	305	
S32 VA	323000/ V2A	5622291	2047 65 3	305		SBM50 SW	M50x1,5346/ St / FSK	5622154	2047 56 5	306	
S40 FT	403000/ St / FT	5069331	2047 31 8	304		SBM63 FT	M63x1,5467/ St / FT	5381334	2047 50 7	305	
S40 G	403000/ St / G	5246312	2047 31 7	305		SBM63 G	M63x1,5467/ St / G	5153900	2047 44 6	305	
S40 SW	403000/ St / FSK	5621768	2047 52 4	305		SBM63 SW	M63x1,5467/ St / FSK	5622161	2047 56 6	306	
S40 VA	403000/ V2A	5622307	2047 65 4	305							
S50 FT	503000/ St / FT	5069348	2047 32 1	304							
S50 G	503000/ St / G	5246329	2047 32 0	305		SH 40 G	0,51200/ St / G	5151272	1488 25 2	323	
S50 SW	503000/ St / FSK	5621775	2047 52 5	305							
S63 FT	633000/ St / FT	5069355	2047 32 4	304		SKT16 G	1645/ Zn / G	5622710	2047 38 8	309	
S63 G	633000/ St / G	5246336	2047 32 3	305		SKT20 G	2050/ Zn / G	5622727	2047 38 9	309	
S63 SW	633000/ St / FSK	5621782	2047 52 6	305		SKT25 G	2562/ Zn / G	5622734	2047 39 0	309	
SAA CPS 4 FT	/ St / FT	5439479	6007 49 8	336		SKT32 G	3267/ Zn / G	5622741	2047 39 1	309	
						SKT40 G	4090/ Zn / G	5622758	2047 39 2	309	
SB16 FT	16178/ St / FT	5381181	2047 48 5	306		SKT50 G	50110/ Zn / G	5622765	2047 39 3	309	
SB16 G	16178/ St / G	5153412	2047 41 0	306		SKTM16 G	M16x1,572/ Zn / G	5622772	2047 40 4	309	
SB16 RO	16178/ St / G/K	5153658	2047 42 5	307		SKTM20 G	M20x1,579/ Zn / G	5622789	2047 40 5	309	
SB16 SW	16178/ St / FSK	5622000	2047 55 2	306		SKTM25 G	M25x1,595/ Zn / G	5622796	2047 40 6	309	
SB16 VA	16178/ V2A	5622543	2047 68 2	307		SKTM32 G	M32x1,597/ Zn / G	5622802	2047 40 7	309	
SB20 FT	20183/ St / FT	5381198	2047 48 6	306		SKTM40 G	M40x1,5137/ Zn / G	5622840	2047 40 8	309	
SB20 G	20183/ St / G	5153429	2047 41 1	306		SKTM50 G	M63x1,5186/ Zn / G	5622857	2047 40 9	309	
SB20 RO	20183/ St / G/K	5153665	2047 42 6	307							
SB20 SW	20183/ St / FSK	5622017	2047 55 3	306		SM16 FT	M16x1,53000/ St / FT	5152880	2047 33 6	304	
SB20 VA	20183/ V2A	5622550	2047 68 3	307		SM16 G	M16x1,53000/ St / G	5246350	2047 33 5	304	
SB25 FT	25207/ St / FT	5381204	2047 48 7	306		SM16 SW	M16x1,53000/ St / FSK	5621799	2047 52 8	304	
SB25 G	25207/ St / G	5153467	2047 41 2	306		SM16 VA	M16x1,53000/ V2A	5622338	2047 65 7	304	
SB25 RO	25207/ St / G/K	5153702	2047 42 7	307		SM20 FT	M20x1,53000/ St / FT	5152910	2047 33 9	304	
SB25 SW	25207/ St / FSK	5622024	2047 55 4	306		SM20 G	M20x1,53000/ St / G	5246367	2047 33 8	304	
SB25 VA	25207/ V2A	5622567	2047 68 4	307		SM20 SW	M20x1,53000/ St / FSK	5621805	2047 52 9	304	
SB32 FT	32245/ St / FT	5381211	2047 48 8	306		SM20 VA	M20x1,53000/ V2A	5622345	2047 65 8	304	
SB32 G	32245/ St / G	5153474	2047 41 3	306		SM25 FT	M25x1,53000/ St / FT	5152927	2047 34 2	304	
SB32 RO	32245/ St / G/K	5153719	2047 42 8	307		SM25 G	M25x1,53000/ St / G	5246374	2047 34 1	304	
SB32 SW	32245/ St / FSK	5622031	2047 55 5	306		SM25 SW	M25x1,53000/ St / FSK	5621812	2047 53 0	304	
SB32 VA	32245/ V2A	5622574	2047 68 5	307		SM25 VA	M25x1,53000/ V2A	5622352	2047 66 0	304	
SB40 FT	40288/ St / FT	5381228	2047 48 9	306		SM32 FT	M32x1,53000/ St / FT	5152934	2047 34 5	304	
SB40 G	40288/ St / G	5153481	2047 41 4	306		SM32 G	M32x1,53000/ St / G	5246381	2047 34 4	304	
SB40 RO	40288/ St / G/K	5153726	2047 42 9	307		SM32 SW	M32x1,53000/ St / FSK	5621829	2047 53 1	304	
SB40 SW	40288/ St / FSK	5622048	2047 55 6	306		SM32 VA	M32x1,53000/ V2A	5622369	2047 66 1	304	
SB40 VA	40288/ V2A	5622581	2047 68 6	307		SM40 FT	M40x1,53000/ St / FT	5152941	2047 34 8	304	
SB50 FT	50346/ St / FT	5381235	2047 49 0	306		SM40 G	M40x1,53000/ St / G	5246398	2047 34 7	304	
SB50 G	50346/ St / G	5153528	2047 41 5	306		SM40 SW	M40x1,53000/ St / FSK	5621836	2047 53 2	304	
SB50 RO	50346/ St / G/K	5153764	2047 43 0	307		SM40 VA	M40x1,53000/ V2A	5622376	2047 66 2	304	
SB50 SW	50346/ St / FSK	5622055	2047 55 7	306		SM50 FT	M50x1,53000/ St / FT	5152972	2047 35 1	304	
SB63 FT	63467/ St / FT	5381242	2047 49 1	306		SM50 G	M50x1,53000/ St / G	5246404	2047 35 0	304	
SB63 G	63467/ St / G	5153535	2047 41 6	306		SM50 SW	M50x1,63000/ St / FSK	5621843	2047 53 3	304	
SB63 RO	63467/ St / G/K	5153771	2047 43 1	307		SM63 FT	M63x1,53000/ St / FT	5152989	2047 35 4	304	
SB63 SW	63467/ St / FSK	5622062	2047 55 8	306		SM63 G	M63x1,53000/ St / G	5246411	2047 35 3	304	
SBM16 FT	M16x1,5178/ St / FT	5381259	2047 50 1	305		SM63 SW	M63x1,53000/ St / FSK	5621850	2047 53 4	304	
SBM16 G	M16x1,5178/ St / G	5153788	2047 44 0	305							
SBM16 SW	M16x1,5178/ St / FSK	5622079	2047 56 0	306		SQ 1632		16 5028154	2153 57 2	312	6401532
SBM16 VA	M16x1,5178/ V2A	5622611	2047 69 0	306							
SBM20 FT	M20x1,5183/ St / FT	5381266	2047 50 2	305							
SBM20 G	M20x1,5183/ St / G	5153825	2047 44 1	305		SQ M6	M615/ PC	5016069	2146 50 9	260	LV1322500
SBM20 SW	20183/ St / FSK	5622086	2047 56 1	306		SQ M8	M815/ PC	5016113	2146 51 1	260	LV1322500
SBM20 VA	M20x1,5183/ V2A	5622628	2047 69 2	306		SQ-10 LGR	109,5-12 / PA	5595359	2146 05 3	260	LV1322501
SBM25 FT	M25x1,5207/ St / FT	5381273	2047 50 3	305		SQ-12 LGR	12-14 11,5-15 / PA	5595410	2146 06 1	260	LV1322501
SBM25 G	M25x1,5207/ St / G	5153832	2047 44 2	305		SQ-15 LGR	15-16 14-16,5 / PA	5595472	2146 09 6	260	LV1322501
SBM25 SW	M25x1,5207/ St / FSK	5622123	2047 56 2	306		SQ-17 LGR	17-19 16-20 / PA	5595533	2146 11 8	260	LV1322501
SBM25 VA	M25x1,5207/ V2A	5622635	2047 69 3	306							
SBM32 FT	M32x1,5245/ St / FT	5381280	2047 50 4	305							
SBM32 G	M32x1,5245/ St / G	5153849	2047 44 3	305							
SBM32 SW	M32x1,5288/ St / FSK	5622130	2047 56 3	306							

01 VBS Katalog 2010_Neuer_Stand / fi / 23/11/2011 (LLExpert_01071)

Tyyppiluettelo

EAN-numeron rakenne: maatumnus 40

valmistajan tunnus 1219 (tuotenumeroille, jotka alkavat numerolla 0 pätee: 1010)

yksilöllinen EAN-C 5647589

Tyyppi	Mitat/väri/eril.	EAN-C.	Tuotenro	Side	Fl-nr.	Tyyppi	Mitat/väri/eril.	EAN-C.	Tuotenro	Side	Fl-nr.
SQ-20 LGR	20-23 19,5-23,5 / PA	5595656	2146 13 4	260	LVI322501	SVM40 FT	M40x1,550/ St / FT	5381150	2047 47 4	307	
SQ-25 LGR	25-28 24-28 / PA	5595717	2146 20 7	260	LVI322502	SVM40 G	M40x1,550/ St / G	5153351	2047 39 9	307	
SQ-28 LGR	28-32 27,5-32 / PA	5595779	2146 21 5	260	LVI322502	SVM40 SW	M40x1,550/ St / G/K	5621973	2047 54 8	307	
						SVM40 VA	M40x1,550/ V2A	5622512	2047 67 8	308	
SQ-32 LGR	32-35 31,2-35,8 / PA	5595830	2146 25 8	260	LVI322502						
SQ-36 LGR	35-40 35-40,1 / PA	5204275	2146 29 0	260	LVI322502	SVM50 FT	M50x1,554/ St / FT	5381167	2047 47 5	307	
						SVM50 G	M50x1,554/ St / G	5153368	2047 40 0	307	
SQ-40 LGR	40-44 39,3-44,5 / PA	5595892	2146 32 0	260	LVI322502	SVM50 SW	M50x1,554/ St / G/K	5621980	2047 54 9	307	
SQ-47 LGR	45-50 44-50 / PA	5204398	2146 36 3	260	LVI322502						
						SVM63 FT	M63x1,565/ St / FT	5381174	2047 47 6	307	
SQ-51 LGR	50-54 48-55 / PA	5595953	2146 44 4	260	LVI322503	SVM63 G	M63x1,565/ St / G	5153405	2047 40 1	307	
SQ-59 LGR	59-65 58,5-65 / PA	5204510	2146 48 7	260	LVI322503	SVM63 SW	M63x1,565/ St / G/K	5621997	2047 55 0	307	
SV16 FT	18,650/ St / FT	5380986	2047 45 5	308		T 100	/ PP	5246794	2007 07 7	170	
SV16 G	18,650/ St / G	5152996	2047 36 5	308							
SV16 RO	18,650/ St / G/K	5153122	2047 38 0	308		T 100 2MSD RO	/ PP	5615897	2007 82 3	179	
SV16 SW	18,650/ St / G/K	5621867	2047 53 6	308		T 100 2MSD WS	/ PP	5615880	2007 82 1	179	
SV16 VA	18,650/ V2A	5622406	2047 66 5	309		T 100 4MSD WS	/ PP	5615903	2007 82 5	179	
						T 100 D 2MSD RO	vaaleanharmaa/ PP	5654575	2007 82 4	179	
SV20 FT	22,654/ St / FT	5380993	2047 45 6	308		T 100 D MSD2A	vaaleanharmaa/ PP	5654582	2007 82 6	179	
SV20 G	22,654/ St / G	5153009	2047 36 6	308		T 100 D MSD4A	vaaleanharmaa/ PP	5654643	2007 82 9	179	
SV20 RO	22,654/ St / G/K	5153160	2047 38 1	308							
SV20 SW	22,654/ St / G/K	5621874	2047 53 7	308							
SV20 VA	22,654/ V2A	5622413	2047 66 6	309		T 100 F	/ PP	5286547	2007 34 7	170	
						T 100 KL	/ PP	5441212	2007 43 6	170	1627182
						T 100 M25-M32	/ PP	5470632	2007 08 1	170	
SV25 FT	28,364/ St / FT	5381006	2047 45 7	308		T 100 OE	/ PP	5246855	2007 25 5	172	
SV25 G	28,364/ St / G	5153047	2047 36 7	308		T 100 RO-LGR	/ PP	5303282	2007 64 4	170	
SV25 RO	28,364/ St / G/K	5153177	2047 38 2	308		T 100 RW	/ PP	5286677	2007 53 3	170	1627162
SV25 SW	28,364/ St / G/K	5621881	2047 53 8	308		T 100 UV RW	/ PP	5441106	2007 41 4	170	
SV25 VA	28,364/ V2A	5622420	2047 66 8	309							
						T 100 WB	/ PP	5615811	2007 80 7	176	
SV32 FT	3574/ St / FT	5381037	2047 45 8	308		T 100 WB 1WS 1SW	/ PP	5615859	2007 81 5	177	
SV32 G	3574/ St / G	5153054	2047 36 8	308		T 100 WB 1WS 2SW	/ PP	5615866	2007 81 7	178	
SV32 RO	3574/ St / G/K	5153184	2047 38 3	308		T 100 WB 2SW	/ PP	5615828	2007 80 9	176	
SV32 SW	3574/ St / G/K	5621898	2047 53 9	308		T 100 WB 2WS 2SW	/ PP	5615873	2007 81 9	178	
SV32 VA	3574/ V2A	5622437	2047 66 9	309		T 100 WB 2WS 4SW	/ PP	5654551	2007 82 0	178	
						T 100 WB 3SW	/ PP	5615842	2007 81 3	177	
SV40 FT	4495/ St / FT	5381044	2047 45 9	308		T 100 WB 4SW	/ PP	5615835	2007 81 1	177	
SV40 G	4495/ St / G	5153061	2047 36 9	308		T 100 WB 6SW	/ PP	5654568	2007 82 2	177	
SV40 RO	4495/ St / G/K	5153221	2047 38 4	308		T 100 ZE IP30	/ PP	5615781	2007 80 5	176	
SV40 SW	4495/ St / G/K	5621904	2047 54 0	308							
SV40 VA	4495/ V2A	5622444	2047 67 0	309							
						T 160	/ PP/GF	5246800	2007 09 3	170	1627153
SV50 FT	54110/ St / FT	5381051	2047 46 0	308		T 160 F	/ PP/GF	5286554	2007 35 5	170	
SV50 G	54110/ St / G	5153108	2047 37 0	308		T 160 KL	/ PP/GF	5682189	2007 44 0	170	1627186
SV50 RO	54110/ St / G/K	5153238	2047 38 5	308		T 160 M32	/ PP/GF	5470649	2007 09 7	170	
SV50 SW	54110/ St / G/K	5621911	2047 54 1	308		T 160 OE	/ PP/GF	5246862	2007 27 1	172	
						T 160 RO-LGR	/ PP/GF	5303299	2007 64 9	170	
SV63 FT	67116/ St / FT	5381068	2047 46 1	308		T 160 RW	/ PP/GF	5286684	2007 54 1	170	1627154
SV63 G	67116/ St / G	5153115	2047 37 1	308		T 160 UV RW	/ PP/GF	5441113	2007 41 6	170	
SV63 RO	67116/ St / G/K	5153245	2047 38 6	308							
SV63 SW	67116/ St / G/K	5621928	2047 54 2	308							
						T 25	/ PP	5246770	2007 02 9	169	
						T 25 F	/ PP	5286486	2007 31 2	169	
						T 25 KL	/ PP	5441168	2007 43 0	169	
SVK16 SW	M16x1,520/ St / G/K	5622178	2047 56 8	309		T 25 RO-LGR	/ PP	5303237	2007 62 2	169	
						T 25 RW	/ PP	5286615	2007 50 9	169	1627159
SVK20 SW	M20x1,523/ St / G/K	5622185	2047 56 9	309		T 25 UV RW	/ PP	5441052	2007 40 8	169	
SVK25 SW	M25x1,528/ St / G/K	5622192	2047 57 0	309		T 250	/ PP/GF	5246817	2007 10 9	170	1627155
						T 250 F	/ PP/GF	5286561	2007 36 3	170	
SVK32 SW	M32x1,536/ St / G/K	5622208	2047 57 1	309		T 250 KL	/ PP/GF	5682196	2007 44 4	170	1627188
						T 250 OE	/ PP/GF	5246879	2007 28 7	172	
SVK40 SW	M40x1,544/ St / G/K	5622215	2047 57 2	309		T 250 RO-LGR	/ PP/GF	5303305	2007 65 7	170	
						T 250 RW	/ PP/GF	5286721	2007 55 4	170	1627156
SVK50 SW	M50x1,555/ St / G/K	5622222	2047 57 3	309		T 250 UV RW	/ PP/GF	5441120	2007 41 8	170	
SVK63 SW	M63x1,568/ St / G/K	5622239	2047 57 4	309							
						T 350	/ PP/GF	5246824	2007 12 5	171	1627157
SVM16 FT	M16x1,532/ St / FT	5381099	2047 47 0	307		T 350 F	/ PP/GF	5286608	2007 37 1	171	
SVM16 G	M16x1,532/ St / G	5153283	2047 39 5	307		T 350 KL	/ PP/GF	5682202	2007 44 8	171	1627189
SVM16 SW	M16x1,532/ St / G/K	5621935	2047 54 4	307		T 350 OE	/ PP/GF	5246886	2007 30 3	173	
SVM16 VA	M16x1,532/ V2A	5622475	2047 67 3	308		T 350 RO-LGR	/ PP/GF	5303312	2007 66 5	171	
						T 350 RW	/ PP/GF	5286738	2007 56 8	171	1627158
SVM20 FT	M20x1,534/ St / FT	5381105	2047 47 1	307		T 350 UV RW	/ PP/GF	5441151	2007 42 0	171	
SVM20 G	M20x1,534/ St / G	5153290	2047 39 6	307							
SVM20 SW	M20x1,532/ St / G/K	5621942	2047 54 5	307		T 40 F	/ PP	5246756	2007 04 5	169	
SVM20 VA	M20x1,540/ V2A	5622482	2047 67 4	308		T 40 F	/ PP	5286493	2007 32 0	169	1627175
SVM25 FT	M25x1,540/ St / FT	5381112	2047 47 2	307		T 40 KL	/ PP	5441175	2007 43 2	169	1627180
SVM25 G	M25x1,540/ St / G	5153306	2047 39 7	307		T 40 OE	/ PP	5246831	2007 22 3	172	
SVM25 SW	M20x1,540/ St / G/K	5621959	2047 54 6	307		T 40 RO-LGR	/ PP	5303244	2007 63 0	169	
SVM25 VA	M25x1,540/ V2A	5622499	2047 67 6	308		T 40 RW	/ PP	5286622	2007 51 7	169	1627160
						T 40 UV RW	/ PP	5441069	2007 41 0	169	
SVM32 FT	M32x1,544/ St / FT	5381129	2047 47 3	307							
SVM32 G	M32x1,544/ St / G	5153344	2047 39 8	307		T 40 ZE IP30	/ PP	5615767	2007 80 1	176	
SVM32 SW	M32x1,544/ St / G/K	5621966	2047 54 7	307							
SVM32 VA	M32x1,544/ V2A	5622505	2047 67 7	308							
						T 60	/ PP	5246787	2007 06 1	169	

Tyyppi	Mitat/väri/eril.	EAN-C.	Tuoteno	Side	FI-nr.	Tyyppi	Mitat/väri/eril.	EAN-C.	Tuoteno	Side	FI-nr.
T 60 F	/ PP	5286509	2007 33 9	169	1627176	TKD 25	M6x25/ St / ZD	5148876	1486 62 4	320	
T 60 KL	/ PP	5441182	2007 43 4	169	1627181	TKD 38	M6x38/ St / ZD	5148937	1486 63 2	320	
T 60 OE	/ PP	5246848	2007 23 9	172		TKD 9	M6x9/ St / ZD	5148753	1486 60 8	320	
T 60 RO-LGR	/ PP	5303275	2007 63 8	169		TKD G	M6,0,22/ St / ZD	5148999	1486 67 5	320	
T 60 RW	/ PP	5286660	2007 52 5	169	1627161						
T 60 UV RW	/ PP	5441090	2007 41 2	169		TKG 13-6	7-13 0,45/ St / ZD	5144373	1483 45 5	316	
T 60 ZE IP30	/ PP	5615774	2007 80 3	176		TK-G 16	10-16 38/ St / ZD	5407041	1481 11 4	316	
T4012 M4x10 G	M4/ St / G	5052036	1134 05 1	341		TKG 19-6	14-19 0,45/ St / ZD	5144434	1483 46 3	316	
T4012 O.S. M4 G	M4/ St / G	5052333	1134 26 4	341		TK-G 20	17-20 38/ St / ZD	5407072	1481 12 0	316	
T4012G M5x13 G	M5/ St / G	5051978	1134 04 3	341		TK-G 4	2-4 28/ St / ZD	5407027	1481 10 2	316	
T4012G O.S. M5 G	M5/ St / G	5052272	1134 25 6	341							
T4012N M4x10 G	M4/ St / G	5051855	1134 02 7	341	1339481	TKG 7-6	3-6,5 0,45/ St / ZD	5144311	1483 44 7	316	
T4012N M4x8 G	M4/ St / G	5491712	1134 30 2	341		TK-G 9	5-9 38/ St / ZD	5407034	1481 10 8	316	
T5012 M5x13 G	M5/ St / G	5052999	1140 01 9	342	1339498						
T5012 O.S. M5 G	M5/ St / G	5053057	1140 21 3	342	1339499	TKI 13-6	7-13 0,45/ St / ZD	5144557	1483 58 7	316	
						TKI 19-6	14-19 0,45/ St / ZD	5144618	1483 59 5	316	
						TKI 7-6	3-6,5 0,45/ St / ZD	5144496	1483 57 9	316	
TC 7-10 ZD	5-7 3-10 / St / ZD	5150732	1487 70 1	318							
TC 9-20 ZD	8-9 7-20 / St / ZD	5150794	1487 72 8	318		TKK 6-240	2-6 240/ St / ZD	5140955	1481 40 1	316	1317607
						TKK 6-365	2-6 365/ St / ZD	5141013	1481 42 8	316	
TK 13-0	5-13 33,3/ St / ZD	5140535	1481 02 9	316	1317605	TKK13-240	5-13 240/ St / ZD	5141075	1481 45 2	316	1317609
TK 19-0	14-19 33,3/ St / ZD	5140658	1481 04 5	316	1317614	TKK13-365	5-13 365/ St / ZD	5141136	1481 46 0	316	
						TKK19-240	14-19 240/ St / ZD	5141310	1481 53 3	316	
						TKK19-365	14-19 365/ St / ZD	5141372	1481 54 1	316	
TK 213	2-13 1,35/ St / ZD	5145936	1484 70 2	319							
TK 6-0	2-6 33,3/ St / ZD	5140474	1481 01 0	316	1317602	TKL 4	1,5-4 52/ St / ZD	5146353	1485 10 5	318	
						TKL 6	4-6 54/ St / ZD	5146414	1485 11 3	318	
TK FL G	0-24 M10/ St / ZD	5407140	1488 11 1	319							
TK GS M10 M12	M10 - M1226/ St / ZD	5407102	1486 69 8	320		TKR 13-10	5-13 M10/ St / ZD	5142218	1482 08 4	317	1317650
TK GS M4 M8	M4 - M819/ St / ZD	5407096	1486 69 4	320		TKR 13-6	5-13 M6/ St / ZD	5142096	1482 06 8	317	
						TKR 13-8	5-13 M8/ St / ZD	5142157	1482 07 6	317	
						TKR 19	14-19 0,9/ St / ZD	5141617	1481 74 6	316	
TKA	2579/ St / ZD	5407089	1486 68 2	320		TKR 19-6	14-19 M6/ St / ZD	5142270	1482 11 4	317	
						TKR 19-8	14-19 M8/ St / ZD	5142331	1482 12 2	317	
TKB 13	5-13 0,8/ St / ZD	5140771	1481 21 5	318		TKR 6	2-6 0,9/ St / ZD	5141433	1481 70 3	316	
TKB 19	14-19 0,8/ St / ZD	5140894	1481 23 1	318		TKR 9	5-9 0,9/ St / ZD	5141495	1481 71 1	316	
TKB 6	2-6 0,8/ St / ZD	5140719	1481 20 7	318							
TKC 13-20	5-13 17-20 / St / ZD	5142812	1482 46 7	317		TKS 13-25	5-13 18-25 / St / ZD	5143598	1483 10 2	317	
TKC 13-25	5-13 23-25 / St / ZD	5142874	1482 47 5	317		TKS 13-32	5-13 28-32 / St / ZD	5143659	1483 11 0	317	
TKC 13-32	5-13 25-32 / St / ZD	5142935	1482 48 3	317		TKS 13-37	5-13 35-37 / St / ZD	5143710	1483 12 9	317	
TKC 19-20	14-19 17-20 / St / ZD	5143178	1482 60 2	317		TKS 13-42	5-13 37-42 / St / ZD	5143772	1483 13 7	317	
TKC 19-25	14-19 23-25 / St / ZD	5143239	1482 61 0	317		TKS 19-25	14-19 18-25 / St / ZD	5144076	1483 30 7	317	
TKC 19-32	14-19 25-32 / St / ZD	5143291	1482 62 9	317		TKS 19-32	14-19 28-32 / St / ZD	5144137	1483 31 5	317	
TKC 6-20	2-6 17-20 / St / ZD	5142638	1482 40 8	317		TKS 19-37	14-19 35-37 / St / ZD	5144199	1483 32 3	317	
TKC 6-25	2-6 23-25 / St / ZD	5142690	1482 41 6	317		TKS 213-25	2-13 18-25 / St / ZD	5145998	1484 81 8	319	
						TKS 213-32	2-13 28-32 / St / ZD	5146056	1484 82 6	319	
						TKS 213-37	2-13 35-37 / St / ZD	5146117	1484 83 4	319	
TKCI 12-7	8,5-12,5 5,5-7 / St / ZD	5150312	1487 41 8	318		TKS 213-42	2-13 37-42 / St / ZD	5146179	1484 84 2	319	
TKCI 12-9	8,5-12,5 8,9-5 / St / ZD	5150374	1487 42 6	318		TKS 6-25	2-6 18-25 / St / ZD	5143352	1483 01 3	317	
TKCI 12-11	8,5-12,5 9,5-11 / St / ZD	5150435	1487 43 4	318		TKS 6-32	2-6 28-32 / St / ZD	5143413	1483 02 1	317	
TKCI 12-14	8,5-12,5 12-14 / St / ZD	5150497	1487 44 2	318	1317771	TKS 6-37	2-6 35-37 / St / ZD	5143475	1483 04 8	317	
TKCI 12-18	8,5-12,5 13-18 / St / ZD	5150558	1487 45 0	318	1317772	TKS 6-42	2-6 37-42 / St / ZD	5143536	1483 05 6	317	
TKCI 12-24	8,5-12,5 19-24 / St / ZD	5150619	1487 46 9	318	1317773						
TKCI 12-32	8,5-12,5 25-32 / St / ZD	5150671	1487 47 7	318	1317774	TKSU 13-25	7-13 18-25 / St / ZD	5145455	1484 40 0	317	
TKCI 5-11	1,5-5 9,5-11 / St / ZD	5149590	1487 02 7	318		TKSU 13-32	7-13 28-32 / St / ZD	5145516	1484 41 9	317	
TKCI 5-14	1,5-5 12-14 / St / ZD	5149651	1487 03 5	318	1317751	TKSU 13-37	7-13 35-37 / St / ZD	5145578	1484 42 7	317	
TKCI 5-18	1,5-5 13-18 / St / ZD	5149712	1487 04 3	318	1317752	TKSU 13-42	7-13 37-42 / St / ZD	5145639	1484 43 5	317	
TKCI 5-24	1,5-5 19-24 / St / ZD	5149774	1487 05 1	318	1317753	TKSU 19-25	14-19 18-25 / St / ZD	5145691	1484 50 8	317	
TKCI 5-32	1,5-5 25-32 / St / ZD	5149835	1487 07 8	318	1317754	TKSU 19-32	14-19 28-32 / St / ZD	5145752	1484 51 6	317	
TKCI 5-7	1,5-5 5,5-7 / St / ZD	5149477	1487 00 0	318		TKSU 19-37	14-19 35-37 / St / ZD	5145813	1484 52 4	317	
TKCI 5-9	1,5-5 8-9,5 / St / ZD	5149538	1487 01 9	318		TKSU 7-25	3-6,5 18-25 / St / ZD	5145219	1484 30 3	317	
TKCI 7-11	5-7 9,5-11 / St / ZD	5150015	1487 22 1	318		TKSU 7-32	3-6,5 28-32 / St / ZD	5145271	1484 31 1	317	
TKCI 7-14	5-7 12-14 / St / ZD	5150077	1487 24 8	318	1317761	TKSU 7-37	3-6,5 35-37 / St / ZD	5145332	1484 33 8	317	
TKCI 7-18	5-7 13-18 / St / ZD	5150138	1487 25 6	318	1317762	TKSU 7-42	3-6,5 37-42 / St / ZD	5145394	1484 34 6	317	
TKCI 7-24	5-7 19-24 / St / ZD	5150190	1487 26 4	318	1317763						
TKCI 7-32	5-7 25-32 / St / ZD	5150251	1487 27 2	318	1317764	TKT	70,45/ St / ZD	5149231	1486 86 1	320	
TKCI 7-7	5-7 5,5-7 / St / ZD	5149897	1487 20 5	318							
TKCI 7-9	5-7 8-9,5 / St / ZD	5149958	1487 21 3	318							
TKCI-A	12-20 37/ St / ZD	5407133	1487 49 6	318		U 15 GS	153000/ St / G	5025399	2003 26 5	191	
TKCU 13-20	7-13 17-20 / St / ZD	5144854	1484 07 9	317							
TKCU 13-25	7-13 23-25 / St / ZD	5144915	1484 08 7	317	1317721	U 20 GS	202500/ St / G	5292319	2004 67 6	191	
TKCU 13-32	7-13 25-32 / St / ZD	5144977	1484 09 5	317	1317733						
TKCU 19-20	14-19 17-20 / St / ZD	5145035	1484 13 3	317	1317722						
TKCU 19-25	14-19 23-25 / St / ZD	5145097	1484 14 1	317		U 25 GS	252000/ St / G	5025450	2003 26 9	191	
TKCU 19-32	14-19 25-32 / St / ZD	5145158	1484 16 8	317	1317734						
TKCU 7-20	3-6,5 17-20 / St / ZD	5144670	1484 00 1	317	1317720						
TKCU 7-25	3-6,5 23-25 / St / ZD	5144731	1484 02 8	317		U 30 GS	302000/ St / G	5292371	2004 68 0	191	
TKCU 7-32	3-6,5 25-32 / St / ZD	5144793	1484 03 6	317	1317732						
TKD 16	M6x16/ St / ZD	5148814	1486 61 6	320		U 35 GS	351500/ St / G	5027676	2003 27 3	191	

01 VBS Katalog 2010_Neuer_Stand / fi / 23/11/2011 (LLEExport_01071)

Tyyppiluettelo

EAN-numeron rakenne: maatumnus 40

valmistajan tunnus 1219 (tuotenumeroille, jotka alkavat numerolla 0 pätee: 1010)

yksilöllinen EAN-C 5647589

Tyyppi	Mitat/väri/eril.	EAN-C.	Tuoteno	Side	FI-nr.	Tyyppi	Mitat/väri/eril.	EAN-C.	Tuoteno	Side	FI-nr.
U 40 GS	40 1000 / St / G	5027737	2003 27 7	191		VTEC EX PG11 SW	Pg 11 musta / PA	5907572	2050 02 1	210	
						VTEC EX PG13.5SW	Pg 13,5 musta / PA	5830290	2050 04 8	210	
UG 60 D	Uppoasennus musta / PS	5000204	2003 01 5	188		VTEC EX PG16 SW	Pg 16 musta / PA	5622093	2050 05 6	210	
UG 60 D NL	Uppoasennus musta / PS	5003694	2003 03 1	188		VTEC EX PG21 SW	Pg 21 musta / PA	5620952	2050 06 4	210	
UG 60 DOS	Uppoasennus musta / PS	5018254	2003 05 8	189		VTEC EX PG29 SW	Pg 29 musta / PA	5618973	2050 07 2	210	
UG 60 FD	valkoinen / PS	5024194	2003 22 3	190		VTEC EX PG36 SW	Pg 36 musta / PA	5615071	2050 08 0	210	
UG 60 PA 12	Uppoasennus punainen / PS	5027911	2003 28 7	191		VTEC EX PG42 SW	Pg 42 musta / PA	5612490	2050 09 9	210	
UG 60 PA 24	Uppoasennus punainen / PS	5028031	2003 29 5	191		VTEC EX PG48 SW	Pg 48 musta / PA	5606017	2050 10 2	210	
UG 60 SD	Uppoasennus punainen / PE	5029298	2003 31 7	192		VTEC EX PG7 SW	Pg 7 musta / PA	5622819	2050 00 5	210	
UG 60 VD	Uppoasennus musta / PS	5002314	2003 01 9	188		VTEC EX PG9 SW	Pg 9 musta / PA	5907633	2050 01 3	210	
UG 60 VD NL	musta 62 / PS	5013457	2003 03 5	189		VTEC EXL PG11 SW	Pg 11 musta / PA	5601210	2050 15 3	210	
UG 60 VK	Uppoasennus musta / PS	5003571	2003 02 3	188		VTEC EXL PG13 SW	Pg 13,5 musta / PA	5600855	2050 16 1	210	
						VTEC EXL PG16 SW	Pg 16 musta / PA	5212232	2050 18 8	210	
UG AS	Uppoasennus musta / PS	5021377	2003 21 2	188		VTEC EXL PG21 SW	Pg 21 musta / PA	5208631	2050 19 6	210	
						VTEC EXL PG9 SW	Pg 9 musta / PA	5829997	2050 14 5	210	
UG UD	valkoinen / PS	5024316	2003 23 6	190		V-TEC KA PG16LGRPG 16 vaaleanharmaa / PA		5313458	2024 86 1	209	
UG UD	valkoinen / PS	5024316	2003 23 6	196		V-TEC L PG11 LGR	Pg 11 vaaleanharmaa / PA	5839651	2024 30 6	209	
						V-TEC L PG11 MS	Pg 11 / CuZn / N	5840855	2085 74 7	237	
UG-UPM1	väritön	5406075	6119 94 0	194		V-TEC L PG11 SGR	Pg 11 hopeanharmaa / PA	5843016	2024 19 5	209	
UG-UPM2	väritön	5406082	6119 94 1	194		V-TEC L PG13 LGRPg 13,5 vaaleanharmaa / PA		5839712	2024 31 4	209	
UG-UPM3	väritön	5406112	6119 94 3	194		V-TEC L PG13 MS	Pg 13,5 / CuZn / N	5840916	2085 75 5	237	
UV 100 D	Uppoasennus 130 / PS	5024439	2003 24 4	191		V-TEC L PG13 SGRPg 13,5 hopeanharmaa / PA		5843078	2024 20 9	209	
						V-TEC L PG16 LGR	Pg 16 vaaleanharmaa / PA	5839774	2024 32 2	209	
UV 100 K	Uppoasennus musta / PS	5023715	2003 11 8	189		V-TEC L PG16 MS	Pg 16 / CuZn / N	5840978	2085 76 3	237	
UV 100 KSD	Uppoasennus punainen / PE	5032717	2003 33 7	192		V-TEC L PG16 SGR	Pg 16 hopeanharmaa / PA	5843139	2024 21 7	209	
UV 150 D	Uppoasennus 200 / PS	5024491	2003 24 8	191		V-TEC L PG21 LGR	Pg 21 vaaleanharmaa / PA	5839835	2024 33 0	209	
UV 150 K	Uppoasennus musta / PS	5023777	2003 12 4	189		V-TEC L PG21 MS	Pg 21 / CuZn / N	5841036	2085 77 1	237	
UV 200 D	Uppoasennus 260 / PS	5025276	2003 25 2	191		V-TEC L PG21 SGR	Pg 21 hopeanharmaa / PA	5843191	2024 22 5	209	
						V-TEC L PG29 LGR	Pg 29 vaaleanharmaa / PA	5839897	2024 34 9	209	
UV 200 K	Uppoasennus musta / PS	5023951	2003 13 0	189	1627177	V-TEC L PG29 MS	Pg 29 / CuZn / N	5841098	2085 79 8	237	
UV 250 D	Uppoasennus 328 / PS	5025337	2003 25 6	191		V-TEC L PG29 SGR	Pg 29 hopeanharmaa / PA	5843252	2024 23 3	209	
UV 250 K	Uppoasennus musta / PS	5024071	2003 13 6	189	1156002	V-TEC L PG36 LGR	Pg 36 vaaleanharmaa / PA	5839958	2024 35 7	209	
						V-TEC L PG36 SGR	Pg 36 hopeanharmaa / PA	5843313	2024 24 1	209	
						V-TEC L PG42 LGR	Pg 42 vaaleanharmaa / PA	5840015	2024 36 5	209	
UV 70 D	musta 36 / PS	5013518	2003 04 3	189		V-TEC L PG48 LGR	Pg 48 vaaleanharmaa / PA	5840077	2024 37 3	209	
UV 70 D NL	Uppoasennus musta / PS	5013570	2003 04 7	189		V-TEC L PG48 MS	Pg 48 / CuZn / N	5841210	2085 83 6	237	
UV 70 FD	valkoinen / PS	5024255	2003 22 7	190		V-TEC L PG7 LGR	Pg 7 vaaleanharmaa / PA	5839538	2024 28 4	209	
UV 70 PA 12	Uppoasennus punainen / PS	5027973	2003 29 1	191		V-TEC L PG7 MS	Pg 7 / CuZn / N	5840732	2085 72 0	237	
UV 70 PA 24	Uppoasennus punainen / PS	5028390	2003 29 9	191		V-TEC L PG7 SGR	Pg 7 hopeanharmaa / PA	5842897	2024 17 9	209	
UV 70 SD	Uppoasennus punainen / PE	5032533	2003 32 1	192		V-TEC L PG9 LGR	Pg 9 vaaleanharmaa / PA	5839590	2024 29 2	209	
UV 80 D	Uppoasennus 102 / PS	5024378	2003 24 0	191		V-TEC L PG9 MS	Pg 9 / CuZn / N	5840794	2085 73 9	237	
UV 80 FD	valkoinen / PS	5291909	2004 63 4	190		V-TEC L PG9 SGR	Pg 9 hopeanharmaa / PA	5842958	2024 18 7	209	
UV 80 K	Uppoasennus musta / PS	5020479	2003 11 2	189		V-TEC M KA M20 M20x1,5 vaaleanharmaa / PA		5502456	2024 82 9	207	
UV 80 KSD	Uppoasennus punainen / PE	5032656	2003 33 3	192		V-TEC PG11 LGR	Pg 11 vaaleanharmaa / PA	5446897	2024 72 1	208	1711011
UW AD	Uppoasennus valkoinen / PS	5024132	2003 21 8	190		V-TEC PG11 MS	Pg 11 / CuZn / N	5190035	2085 62 3	237	1729403
UW ASD	Uppoasennus punainen / PE	5032595	2003 32 5	192		V-TEC PG11 SGR	Pg 11 hopeanharmaa / PA	5160816	2022 62 1	208	1711013
UWA	Uppoasennus valkoinen / PS	5022633	2003 08 2	190		V-TEC PG13 LGR	Pg 13,5 vaaleanharmaa / PA	5446958	2024 74 8	208	1711013
VBX 25 M	vaaleanharmaa / PP	5128052	2008 07 6	167		V-TEC PG13 MS	Pg 13,5 / CuZn / N	5190097	2085 63 1	237	1729404
VBX 25 M 5	vaaleanharmaa / PP	5128953	2008 44 0	167		V-TEC PG13.5 SGRPg 13,5 hopeanharmaa / PA		5160878	2022 64 8	208	1711016
VBX 60 M	vaaleanharmaa / PP	5126379	2008 11 4	167	1627172	V-TEC PG16 LGR	Pg 16 vaaleanharmaa / PA	5447016	2024 75 6	208	1711016
VBX 60 M 5	vaaleanharmaa / PP	5126430	2008 56 4	167	1627172	V-TEC PG16 MS	Pg 16 / CuZn / N	5190158	2085 65 8	237	1729405
VBX KL25	vaaleanharmaa / PA	5448990	2009 10 2	168	1627173	V-TEC PG16 SGR	Pg 16 hopeanharmaa / PA	5160939	2022 65 6	208	1711021
VBX KL25	vaaleanharmaa / PA	5448990	2009 10 2	175	1627173	V-TEC PG21 LGR	Pg 21 vaaleanharmaa / PA	5447078	2024 76 4	208	1711021
VBX KL60	vaaleanharmaa / PA	5449058	2009 11 0	168	1627173	V-TEC PG21 MS	Pg 21 / CuZn / N	5448631	2085 66 6	237	1729406
VBX KL60	vaaleanharmaa / PA	5449058	2009 11 0	175	1627173	V-TEC PG21 SGR	Pg 21 hopeanharmaa / PA	5160991	2022 66 4	208	1711029
VBX MO	50 / St / FS	5456018	2008 97 1	168	1462165	V-TEC PG29 LGR	Pg 29 vaaleanharmaa / PA	5447139	2024 77 2	208	1711029
VTEC EX M12 SW	M12 x 1,5 musta / PA	5596295	2050 30 7	211		V-TEC PG29 MS	Pg 29 / CuZn / N	5448693	2085 67 4	237	1729407
VTEC EX M16 SW	M16 x 1,5 musta / PA	5594857	2050 31 5	211		V-TEC PG29 SGR	Pg 29 hopeanharmaa / PA	5161059	2022 67 2	208	1711036
VTEC EX M20 SW	M20 x 1,5 musta / PA	5594734	2050 32 3	211		V-TEC PG36 LGR	Pg 36 vaaleanharmaa / PA	5447191	2024 78 0	208	1711036
VTEC EX M25 SW	M25 x 1,5 musta / PA	5594673	2050 33 1	211							
VTEC EX M32 SW	M32 x 1,5 musta / PA	5594611	2050 35 8	211							
VTEC EX M40 SW	M40 x 1,5 musta / PA	5315131	2050 36 6	211							
VTEC EX M50 SW	M50 x 1,5 musta / PA	5316695	2050 37 4	211							
VTEC EX M63 SW	M63 x 1,5 musta / PA	5373391	2050 38 2	211							

01 VBS Katalog 2010_Neuer_Stand / fi / 23/11/2011 (LLEExport_01071)

Tyyppi	Mitat/väri/eril.	EAN-C.	Tuoteno	Side	Fl-nr.	Tyyppi	Mitat/väri/eril.	EAN-C.	Tuoteno	Side	Fl-nr.
V-TEC PG36 MS	Pg 36 / CuZn / N	5448754	2085 68 2	237	1729408	V-TEC VM20 EMV-K	M20x1,5/ CuZn / N	5655480	2086 16 9	238	1729651
V-TEC PG36 SGR	Pg 36 hopeanharmaa / PA	5161110	2022 68 0	208		V-TEC VM20 LGRM20 x 1,5vaaleanharmaa / PA		5533658	2022 86 6	206	1711120
V-TEC PG42 LGR	Pg 42 vaaleanharmaa / PA	5447252	2024 79 9	208	1711042	V-TEC VM20 MS	M20 x 1,5/ CuZn / N	5809418	2086 03 0	236	
V-TEC PG42 MS	Pg 42 / CuZn / N	5448815	2085 69 0	237	1729409	V-TEC VM20 SGRM20 x 1,5hopeanharmaa / PA		5532750	2022 84 7	206	
V-TEC PG42 SGR	Pg 42 hopeanharmaa / PA	5161172	2022 69 9	208		V-TEC VM20 SW	M20 x 1,5musta / PA	5535690	2022 88 7	206	
V-TEC PG48 LGR	Pg 48 vaaleanharmaa / PA	5447313	2024 80 2	208	1711048	V-TEC VM25 EMV	M25 x 1,5/ CuZn / N	5655596	2086 21 5	238	
V-TEC PG48 MS	Pg 48 / CuZn / N	5448877	2085 70 4	237	1729410	V-TEC VM25 EMV-K	M25x1,5/ CuZn / N	5655497	2086 17 3	238	1729652
V-TEC PG48 SGR	Pg 48 hopeanharmaa / PA	5161233	2022 70 2	208		V-TEC VM25 LGRM25 x 1,5vaaleanharmaa / PA		5533719	2022 86 8	206	1711125
V-TEC PG7 LGR	Pg 7 vaaleanharmaa / PA	5446774	2024 70 5	208	1711007	V-TEC VM25 MS	M25 x 1,5/ CuZn / N	5809593	2086 03 6	236	
V-TEC PG7 MS	Pg 7 / CuZn / N	5189916	2085 60 7	237	1729401	V-TEC VM25 SGRM25 x 1,5hopeanharmaa / PA		5532811	2022 84 9	206	
V-TEC PG7 SGR	Pg 7 hopeanharmaa / PA	5160694	2022 60 5	208		V-TEC VM25 SW	M25 x 1,5musta / PA	5535751	2022 88 9	206	
V-TEC PG9 LGR	Pg 9 vaaleanharmaa / PA	5446835	2024 71 3	208	1711009	V-TEC VM32 EMV	M32 x1,5/ CuZn / N	5655602	2086 21 9	238	
V-TEC PG9 MS	Pg 9 / CuZn / N	5189978	2085 61 5	237	1729402	V-TEC VM32 EMV-K	M32x1,5/ CuZn / N	5655503	2086 17 7	238	1729653
V-TEC PG9 SGR	Pg 9 hopeanharmaa / PA	5160755	2022 61 3	208		V-TEC VM32 LGRM32 x 1,5vaaleanharmaa / PA		5533771	2022 87 0	206	1711132
V-TEC RA		5033912	3010 20 1	211		V-TEC VM32 MS	M32 x 1,5/ CuZn / N	5809777	2086 04 2	236	
V-TEC RA SET		5034278	3010 27 5	211		V-TEC VM32 SGRM32 x 1,5hopeanharmaa / PA		5532934	2022 85 1	206	
V-TEC ST15	M12 15	5034032	3010 23 6	211		V-TEC VM32 SW	M32 x 1,5musta / PA	5538219	2022 89 1	206	
V-TEC ST20	M16 20	5034094	3010 24 4	211		V-TEC VM40 EMV	M40 x 1,5/ CuZn / N	5655619	2086 22 3	238	
V-TEC ST24	M20 24	5034155	3010 25 2	211		V-TEC VM40 EMV-K	M40x1,5/ CuZn / N	5655534	2086 18 1	238	1729654
V-TEC ST29	M25 29	5034216	3010 26 0	211		V-TEC VM40 LGRM40 x 1,5vaaleanharmaa / PA		5533832	2022 87 2	206	1711140
V-TEC VM L12 LGR	M12 x 1,5vaaleanharmaa / PA	5004127	2022 94 3	207		V-TEC VM40 MS	M40 x 1,5/ CuZn / N	5809890	2086 04 8	236	
V-TEC VM L12 SGR	M12 x 1,5hopeanharmaa / PA	5003786	2022 92 1	207		V-TEC VM40 SGRM40 x 1,5hopeanharmaa / PA		5532996	2022 85 3	206	
V-TEC VM L12 SW	M12 x 1,5musta / PA	5004363	2022 96 4	207		V-TEC VM40 SW	M40 x 1,5musta / PA	5538332	2022 89 3	206	
V-TEC VM L16 LGR	M16 x 1,5vaaleanharmaa / PA	5004141	2022 94 5	207		V-TEC VM50 EMV	M50 x 1,5/ CuZn / N	5655626	2086 22 7	238	
V-TEC VM L16 SGR	M16 x 1,5hopeanharmaa / PA	5003823	2022 92 4	207		V-TEC VM50 EMV-K	M50x1,5/ CuZn / N	5655541	2086 18 5	238	1729655
V-TEC VM L16 SW	M16 x 1,5musta / PA	5004370	2022 96 6	207		V-TEC VM50 LGRM50 x 1,5vaaleanharmaa / PA		5533894	2022 87 4	206	1711150
V-TEC VM L20 LGR	M20 x 1,5vaaleanharmaa / PA	5004158	2022 94 7	207		V-TEC VM50 MS	M50 x 1,5/ CuZn / N	5810070	2086 05 4	236	
V-TEC VM L20 SGR	M20 x 1,5hopeanharmaa / PA	5003885	2022 92 6	207		V-TEC VM50 SGRM50 x 1,5hopeanharmaa / PA		5533054	2022 85 5	206	
V-TEC VM L20 SW	M20 x 1,5musta / PA	5004387	2022 96 8	207		V-TEC VM50 SW	M50 x 1,5musta / PA	5538455	2022 89 5	206	
V-TEC VM L25 LGR	M25 x 1,5vaaleanharmaa / PA	5004202	2022 94 9	207		V-TEC VM63 EMV	M63 x 1,5/ CuZn / N	5655657	2086 23 1	238	
V-TEC VM L25 SGR	M25 x 1,5hopeanharmaa / PA	5003908	2022 92 8	207		V-TEC VM63 EMV-K	M63x1,5/ CuZn / N	5655558	2086 18 9	238	1729656
V-TEC VM L25 SW	M25 x 1,5musta / PA	5004424	2022 97 0	207		V-TEC VM63 LGRM63 x 1,5vaaleanharmaa / PA		5533955	2022 87 6	206	1711163
V-TEC VM L32 LGR	M32 x 1,5vaaleanharmaa / PA	5004240	2022 95 1	207		V-TEC VM63 MS	M63 x 1,5/ CuZn / N	5810131	2086 06 0	236	
V-TEC VM L32 SGR	M32 x 1,5hopeanharmaa / PA	5003946	2022 93 0	207		V-TEC VM63 SGRM63 x 1,5hopeanharmaa / PA		5533115	2022 85 7	206	
V-TEC VM L32 SW	M32 x 1,5musta / PA	5004486	2022 97 2	207		V-TEC VM63 SW	M63 x 1,5musta / PA	5538516	2022 89 7	206	
V-TEC VM L40 LGR	M40 x 1,5vaaleanharmaa / PA	5004257	2022 95 3	207		W-Cut		5647447	5303 76 7	301	
V-TEC VM L40 SGR	M40x1,5hopeanharmaa / PA	5004004	2022 93 3	207		WN 7855 A 10	10 4000 / St / GTP	5029113	1043 19 6	287	
V-TEC VM L40 SW	M40 x 1,5musta / PA	5004493	2022 97 4	207		WN 7855 A 12	12 2000 / St / GTP	5029175	1043 22 6	287	
V-TEC VM L50 LGR	M50 x 1,5vaaleanharmaa / PA	5004264	2022 95 5	207		WN 7855 A 14	14 2000 / St / GTP	5029236	1043 24 2	287	
V-TEC VM L50 SGR	M50x1,5hopeanharmaa / PA	5004028	2022 93 5	207		WN 7855 A 2	2 4000 / St / GTP	5028451	1043 01 3	287	
V-TEC VM L50 SW	M50 x 1,5musta / PA	5004509	2022 97 6	207		WN 7855 A 2.5	2,5 4000 / St / GTP	5028512	1043 02 1	287	
V-TEC VM L63 LGR	M63 x 1,5vaaleanharmaa / PA	5004301	2022 95 7	207		WN 7855 A 4	4 4000 / St / GTP	5028697	1043 06 4	287	
V-TEC VM L63 SGR	M63x1,5hopeanharmaa / PA	5004066	2022 93 7	207		WN 7855 A 4.5	4,5 4000 / St / GTP	5028758	1043 07 2	287	
V-TEC VM L63 SW	M63 x 1,5musta / PA	5004547	2022 97 8	207		WN 7855 A 5	5 4000 / St / GTP	5028819	1043 08 0	287	
V-TEC VM LM12 MS	M12 x 1,5 / CuZn / N	5810254	2086 11 1	236		WN 7855 A 6	6 4000 / St / GTP	5028871	1043 10 2	287	
V-TEC VM LM16 MS	M16 x 1,5 / CuZn / N	5810377	2086 11 7	236		WN 7855 A 7	7 4000 / St / GTP	5028932	1043 12 9	287	
V-TEC VM LM20 MS	M20 x 1,5 / CuZn / N	5810438	2086 12 3	236		WN 7855 A 8	8 4000 / St / GTP	5028994	1043 14 5	287	
V-TEC VM LM25 MS	M25 x 1,5 / CuZn / N	5810735	2086 12 9	236		WN 7855 A 9	9 4000 / St / GTP	5029052	1043 16 1	287	
V-TEC VM LM32 MS	M32 x 1,5 / CuZn / N	5810858	2086 13 5	236		WN 7855 B 10	10 2400 / St / GTP	5030133	1044 19 2	288	
V-TEC VM LM40 MS	M40 x 1,5 / CuZn / N	5810971	2086 14 1	236		WN 7855 B 12	12 1800 / St / GTP	5030195	1044 21 4	288	
V-TEC VM LM50 MS	M50 x 1,5 / CuZn / N	5811152	2086 14 7	236		WN 7855 B 14	14 1200 / St / GTP	5030256	1044 23 0	288	
V-TEC VM LM63 MS	M63 x 1,5 / CuZn / N	5811213	2086 15 3	236		WN 7855 B 16	16 1200 / St / GTP	5030317	1044 25 7	288	
V-TEC VM12 EMV	M12 x 1,5 / CuZn / N	5655565	2086 20 3	238		WN 7855 B 3	3 5000 / St / GTP	5029595	1044 04 4	288	
V-TEC VM12 LGRM12 x 1,5vaaleanharmaa / PA		5533177	2022 86 2	206	1711112	WN 7855 B 4	4 5000 / St / GTP	5029717	1044 06 0	288	
V-TEC VM12 MS	M12 x 1,5 / CuZn / N	5808992	2086 01 8	236		WN 7855 B 4.5	4,5 5000 / St / GTP	5029779	1044 07 9	288	
V-TEC VM12 SGRM12 x 1,5hopeanharmaa / PA		5532637	2022 84 3	206		WN 7855 B 5	5 5000 / St / GTP	5029830	1044 08 7	288	
V-TEC VM12 SW	M12 x 1,5musta / PA	5534013	2022 88 3	206		WN 7855 B 6	6 5000 / St / GTP	5029892	1044 10 9	288	
V-TEC VM16 EMV	M16 x 1,5 / CuZn / N	5655572	2086 20 7	238		WN 7855 B 7	7 4800 / St / GTP	5029953	1044 12 5	288	
V-TEC VM16 EMV-K	M16x1,5 / CuZn / N	5655435	2086 16 5	238	1729650						
V-TEC VM16 LGRM16 x 1,5vaaleanharmaa / PA		5533238	2022 86 4	206	1711116						
V-TEC VM16 MS	M16 x 1,5 / CuZn / N	5809234	2086 02 4	236							
V-TEC VM16 SGRM16 x 1,5hopeanharmaa / PA		5532699	2022 84 5	206							
V-TEC VM16 SW	M16 x 1,5musta / PA	5535638	2022 88 5	206							
V-TEC VM20 EMV	M20 x 1,5 / CuZn / N	5655589	2086 21 1	238							

01 VBS Katalog 2010_Neuer_Stand / fi / 23/11/2011 (LLEExport_01071)

Tyyppiluettelo

EAN-numeron rakenne: maatunnus 40

valmistajan tunnus 1219 (tuotenumeroille, jotka alkavat numerolla 0 pätee: 1010)

yksilöllinen EAN-C 5647589

Tyyppi	Mitat/väri/eril.	EAN-C.	Tuotenro	Side	Fl-nr.					
WN 7855 B 8	84800 / St / GTP	5030010	1044 14 1	288						
WN 7855 B 9	92400 / St / GTP	5030072	1044 17 6	288						

01 VBS Katalog 2010_Neuer_Stand / fi / 23/11/2011 (LLEExport_01071)

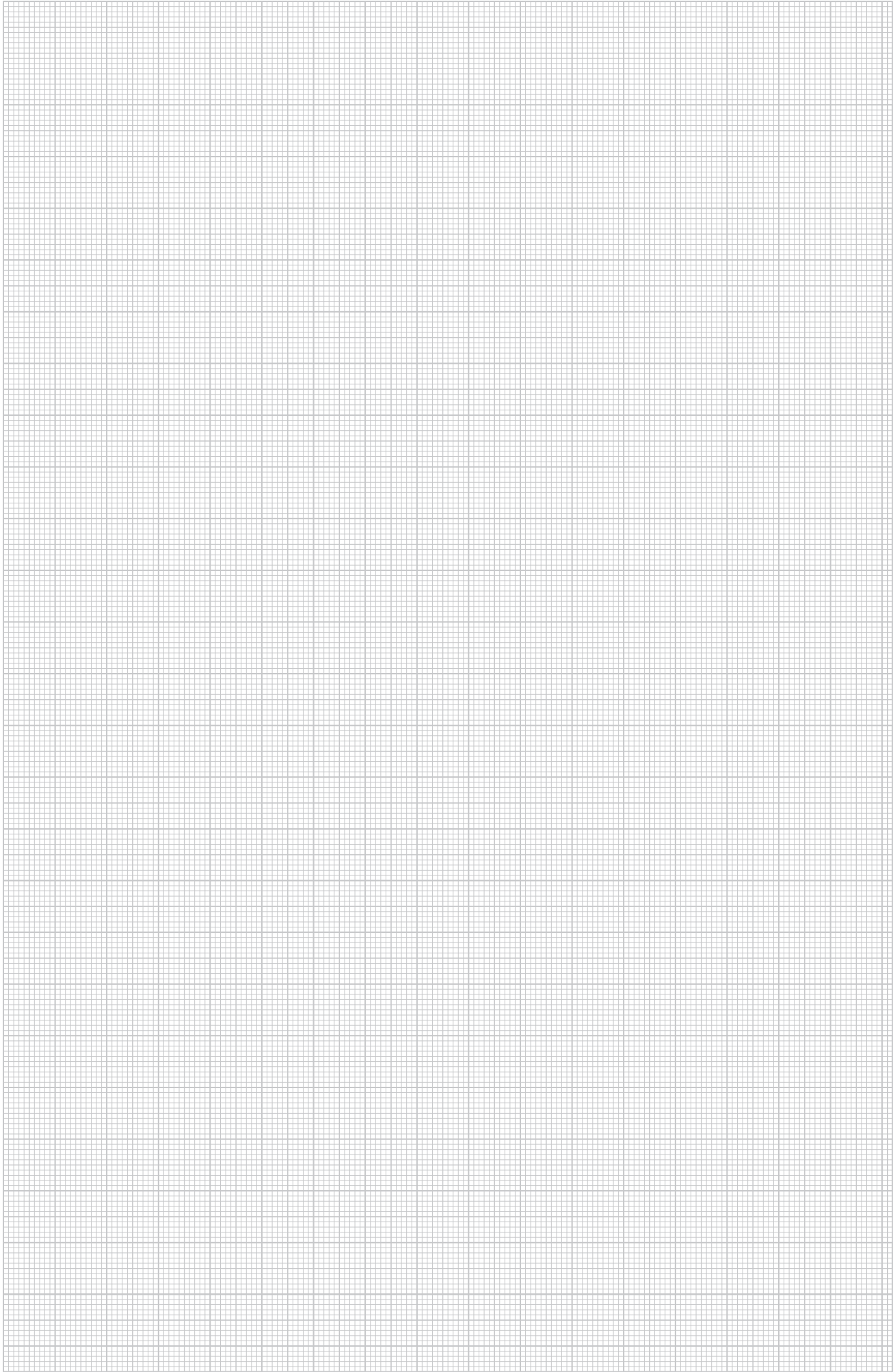



OBO Bettermann Oy

Ruosilantie 18
00390 Helsinki

Asiakaspalvelu

Puh: 0207 417 500
Fax: 0207 417 501
E-Mail: info@obo.fi

www.obo.fi