

PRESSOSTAT

Swiss based Trafag is a leading international supplier of high quality sensors and monitoring instruments for measurement of pressure and temperature.

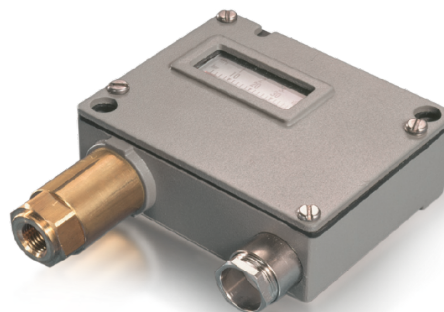

Applications

- Shipbuilding
- Engine manufacturing
- Railways
- Machine tools
- Hydraulics

Features

- Rugged aluminium housing
- Protection IP65
- Any mounting position possible

Technical Data



Measuring principle	Bellow	Repeatability	± 1.0 % FS typ.
Measuring range	-0.9 ... 1.5 to 10 ... 100 bar 5 ... 50 to 125 ... 1500 psi	Media temperature	-40°C ... +150°C
Output signal	1 Floating change-over contact (SPDT)	Ambient temperature	-25°C ... +70°C
Switching differential	Not adjustable	Approval / conformity	ABS, BV, CCS, DNV, GL, KRS, LRS, RINA EN60730-1/ EN60730-2-6: Typ 2.B.H

02/2017

Data sheet H72252s



Subject to change

Ordering information/type code

		XXX	XX	XX	XXXXXX	XX	XX	
Custom build code	With display and adjusting screw	900						
	Without display, with adjusting screw	904						
	With display and adjusting knob	912						
Microswitch	Small switching differential, standard vibration resistance ^{1) 2)}					10		
	Average switching differential, standard vibration resistance ¹⁾					11		
	Average switching differential, increased vibration resistance  ¹⁾					23		
	Large switching differential, high vibration resistance  ¹⁾					26		
	With gold plated contacts, standard vibration resistance ¹⁾					21		
Range	Range [bar]	Over pressure [bar]	Burst pressure [bar]		Range [psi]	Over pressure [psi]	Burst pressure [psi]	
	-0.9 ... 1.5	10	13	72	5 ... 50	175	350	G6
	0.2 ... 1.6	10	13	73	10 ... 100	350	500	G8
	0.2 ... 2.5	10	13	75	25 ... 200	350	500	G9
	0 ... 4	12	26	76	50 ... 500	500	1000	H1
	0 ... 6	12	26	77	125 ... 1500	1500	2300	H3
	1 ... 10	24	36	78				
	1 ... 16	24	36	79				
	2 ... 25	40	75	80				
	4 ... 40	40	75	81				
	6 ... 60	100	160	82				
10 ... 100	100	160	83					

Sensor	Sensor material	Sensor housing material	Thread	Range		Sensor material	Sensor housing material	Thread	Range	
	Bronze bellow (CuSn6)	Brass (CuZn39Pb3)	G1/4" female	72	900	Bronze bellow (CuSn6)	Brass chemically nickel plated	G1/4" female	78, 79	955
	Bronze bellow (CuSn6)	Brass (CuZn39Pb3)	G1/4" female	73, 75	901	Bronze bellow (CuSn6)	Brass chemically nickel plated	G1/4" female	80, 81	957
	Bronze bellow (CuSn6)	Brass (CuZn39Pb3)	G1/4" female	76, 77	903	Bronze bellow (CuSn6)	Brass chemically nickel plated	G1/2" male	72	959
	Bronze bellow (CuSn6)	Brass (CuZn39Pb3)	G1/4" female	78, 79	905	Bronze bellow (CuSn6)	Brass chemically nickel plated	G1/2" male	73, 75	952
	Bronze bellow (CuSn6)	Brass (CuZn39Pb3)	G1/4" female	80, 81	907	Bronze bellow (CuSn6)	Brass chemically nickel plated	G1/2" male	76, 77	954
	Stainless steel 1.4435	Brass (CuZn39Pb3)	G1/4" female	82, 83	940	Bronze bellow (CuSn6)	Brass chemically nickel plated	G1/2" male	78, 79	956
	Bronze bellow (CuSn6)	Brass (CuZn39Pb3)	G1/2" male	72	909	Bronze bellow (CuSn6)	Brass chemically nickel plated	G1/2" male	80, 81	958
	Bronze bellow (CuSn6)	Brass (CuZn39Pb3)	G1/2" male	73, 75	902	Stainless steel 1.4435	Brass nickel plated	G1/4" female	72	800
	Bronze bellow (CuSn6)	Brass (CuZn39Pb3)	G1/2" male	76, 77	904	Stainless steel 1.4435	Brass nickel plated	G1/4" female	73, 75	801
	Bronze bellow (CuSn6)	Brass (CuZn39Pb3)	G1/2" male	78, 79	906	Stainless steel 1.4435	Brass nickel plated	G1/4" female	76, 77	803
	Bronze bellow (CuSn6)	Brass (CuZn39Pb3)	G1/2" male	80, 81	908	Stainless steel 1.4435	Brass nickel plated	G1/4" female	78, 79	805
	Stainless steel 1.4435	Brass	G1/2" male	82, 83	941	Stainless steel 1.4435	Brass nickel plated	G1/4" female	80, 81	807
	Bronze bellows (CuSn6)	Brass (CuZn39Pb3)	1/4"NPT female	G6	G6.103	Stainless steel 1.4435	Brass nickel plated	G1/4" female	82, 83	840
	Bronze bellows (CuSn6)	Brass (CuZn39Pb3)	1/4"NPT female	G8	G8.105	Stainless steel 1.4435	Brass nickel plated	G1/2" male	72	809
	Bronze bellows (CuSn6)	Brass (CuZn39Pb3)	1/4"NPT female	G9	G9.105	Stainless steel 1.4435	Brass nickel plated	G1/2" male	73, 75	802
	Bronze bellows (CuSn6)	Brass (CuZn39Pb3)	1/4"NPT female	H1	H1.107	Stainless steel 1.4435	Brass nickel plated	G1/2" male	76, 77	804
	Bronze bellows (CuSn6)	Brass (CuZn39Pb3)	1/4"NPT female	H3	H3.140	Stainless steel 1.4435	Brass nickel plated	G1/2" male	78, 79	806
	Bronze bellow (CuSn6)	Brass chemically nickel plated	G1/4" female	72	950	Stainless steel 1.4435	Brass nickel plated	G1/2" male	80, 81	808
	Bronze bellow (CuSn6)	Brass chemically nickel plated	G1/4" female	73, 75	951	Stainless steel 1.4435	Brass nickel plated	G1/2" male	82, 83	841
	Bronze bellow (CuSn6)	Brass chemically nickel plated	G1/4" female	76, 77	953					

XXX XX XX XXXXXX XX XX

Fixing	Direct on sensor or housing	00
	With mounting bracket	31
Accessories	Lead seal (manipulation protection)	16
	Screwed cable gland M20x1.5 (EN50262) 	07
	Screwed cable gland M24x1.5 (DIN89280) 	27
	Screwed cable gland M18x1.5 (DIN89280) 	40
	Without screwed cable gland	33
	Railway version (UIC 616)	28
	Damping elements and snubber see data sheet H72258	

¹⁾ Switching differential not adjustable

²⁾ Not suitable for applications under vibration

Standard products (extra short lead time)

Product No.	Type Code	Pressure range [bar]	Over pressure max. [bar]	Switching differential [bar]	Diameter Y [mm]	Length X [mm]
P1.5	900 2672 900	-0.9 ... 1.5	10	0.1 (fixed)	45	56.5
P2.5	900 2675 901	0.2 ... 2.5	10	0.1 (fixed)	45	56.5
P4	900 2376 903	0 ... 4	12	0.2 (fixed)	33	47
P6	900 2377 903	0 ... 6	12	0.2 (fixed)	33	47
P10	900 2378 905	1 ... 10	24	0.4 (fixed)	27	42.5
P16	900 2379 905	1 ... 16	24	0.4 (fixed)	27	42.5
P25	900 2380 907	2 ... 25	40	1 (fixed)	33	47
P40	900 2381 907	4 ... 40	40	1 (fixed)	33	47
PS1.5	904 2672 900	-0.9 ... 1.5	10	0.1 (fixed)	45	56.5
PS2.5	904 2675 901	0.2 ... 2.5	10	0.1 (fixed)	45	56.5
PS6	904 2377 903	0 ... 6	12	0.2 (fixed)	33	47
PS16	904 2379 905	1 ... 16	24	0.4 (fixed)	27	42.5
PS40	904 2381 907	4 ... 40	40	1 (fixed)	27	42.5

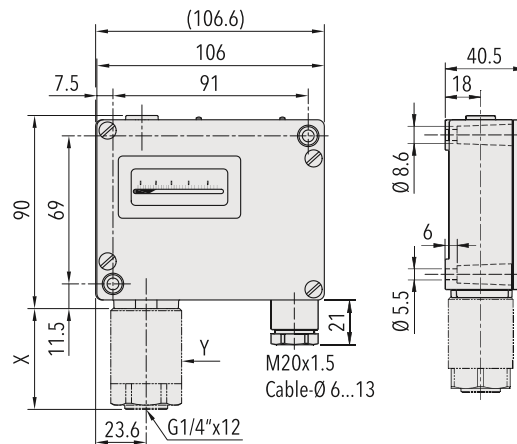

Specifications		
Accuracy	Repeatability	± 1.0 % FS typ.
	Scale accuracy typ.	± 2.0 % FS typ.
	Switching differential	See table
	Adjustment range switchpoint ¹⁾	10% ... 90% FS
Environmental conditions	Ambient temperature	-25°C ... +70°C
	Media temperature	-40°C ... +150°C
	Storage temperature	-25°C ... +85°C
	Protection	IP65
	Humidity	Max. 95% relative
	Vibration	Switch 23/26, 5...25 Hz: ±1.6 mm 25...100 Hz: 4g Ranges 72, 73, 75, 5...50 Hz: 20 mm/sec.
	Shock	50 g / 11ms
Mechanical Data	Sensor	See ordering information
	Housing	AlSi10Mg/ Epoxy coated
	Sealing	NBR
	Housing seal	EPDM 75 Sh
	Screwed cable gland	Brass nickel plated
	Male electrical plug	PA, Polyamide
	Mounting torque	max. 25 Nm
	Installation	any position
	Weight	~ 710 g
Microswitch	Rating	See table
	Resistance of insulation	> 2 MΩ
	Dielectric strength	U ≤ 250V: 1.45 kV / U ≤ 500V: 2 kV terminal ground
	Life time (mechanical)	Microswitch 10/11: 20 Mio. cycles Microswitch 21: 0.5 Mio. cycles Microswitch 23/26: 0.3 Mio. cycles
Electrical connection	Electrical connections	Terminal screw
	Cable gland	M20x1.5 Cable-Ø 6...13 mm
	Terminal screw	3 x 1.5...4 mm ²

¹⁾ Other adjustment ranges upon request

Additional information		
Documents	Data sheet	www.trafag.com/H72252
	Instructions	www.trafag.com/H71261
	Flyer	www.trafag.com/H70911

Dimensions

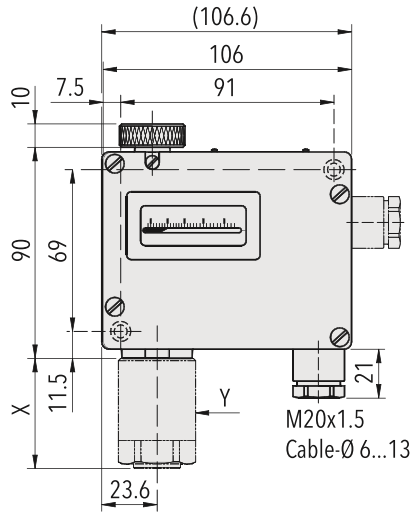

Dimension X and Y see data sheet H72271

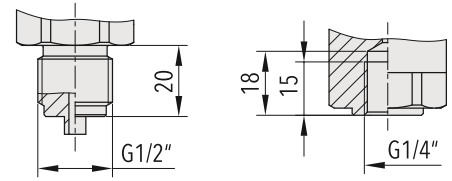
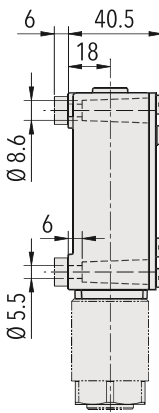

G1/2" male

G1/4" female

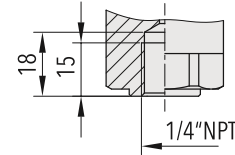

1/4" NPT female

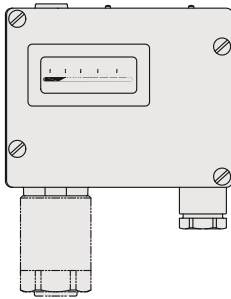

900.XX.XX.XXX.XX.XX

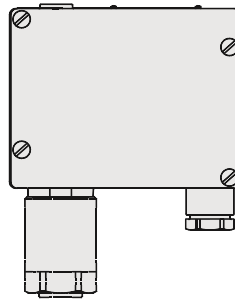

904.XX.XX.XXX.XX.XX

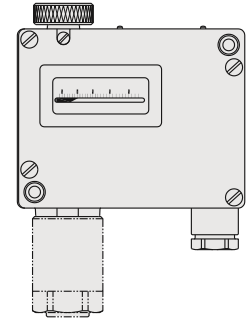

912.XX.XX.XXX.XX.XX

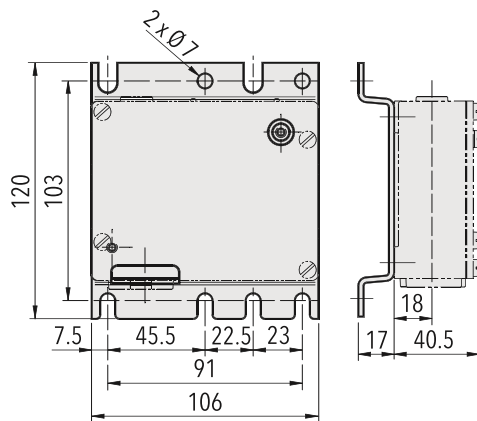

9XX.XX.XX.XXX.31.XX

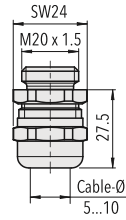

9XX.XX.XX.XXX.XX.07
M20x1.5

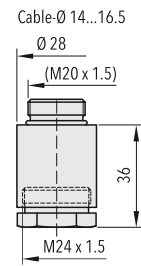

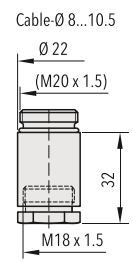

9XX.XX.XX.XXX.XX.27
M24x1.5



9XX.XX.XX.XXX.XX.40
M18x1.5

Switching differential typ. @ 25°C						
Measuring range of bellows sensor	[bar]	-0.9 ... 1.5 0.2 ... 1.6 0.2 ... 2.5	0 ... 4 0 ... 6	1 ... 10 1 ... 16	2 ... 25 4 ... 40	6 ... 60 10 ... 100
Microswitch 10 Switching differential (not adjustable)	[bar]	0.03	0.08	0.2	0.5	1.5
Microswitch 11/21/23 Switching differential (not adjustable)	[bar]	0.1	0.2	0.4	1.0	3.0
Microswitch 26 Switching differential (not adjustable)	[bar]	0.1	0.3	0.8	2.0	5.0
Measuring range of bellows sensor	[psi]	5 ... 50	10 ... 100 25 ... 200	50 ... 500	125 ... 1500	
Microswitch 10 Switching differential (not adjustable)	[psi]	1.2	3	7.5	22	
Microswitch 11/21/23 Switching differential (not adjustable)	[psi]	3	6	14.5	44	
Microswitch 26 Switching differential (not adjustable)	[psi]	4.4	12	30	72.5	

Electrical data switch			
Type	Features	Rating	
		Resistive Load (Inductive Load)	
		AC	DC
10	Small switching differential (not recommended for applications under vibrations)	125 V 10 (1.5) A 250 V 10 (1.25) A	250 V 0.2 (0.02) A 125 V 0.4 (0.03) A 30 V 2 (1) A 14 V 15 (2.5) A
11	Average switching differential, standard vibration resistance	125 V 15 (1.5) A 250 V 15 (1.25) A 500 V 10 (0.75) A	250 V 0.25 (0.03) A 125 V 0.5 (0.05) A 30 V 6 (1.5) A 14 V 15 (1.5) A
23 	Average switching differential, increased vibration resistance	125 V 15 (1.5) A 250 V 15 (1.25) A 500 V 10 (0.75) A	250 V 0.3 (0.05) A 125 V 0.6 (0.1) A 30 V 15 (1.5) A 14 V 15 (1.5) A
26 	Large switching differential, high vibration resistance	125 V 15 (1.5) A 250 V 15 (1.25) A 500 V 10 (0.75) A	250 V 0.3 (0.2) A 125 V 0.75 (0.4) A 30 V 15 (1.5) A 14 V 15 (1.5) A
21	With gold plated contacts, standard vibration resistance	24 V 0.1 (0.1) A 12 V 1.0 (1.0) A 5 V 2.0 (2.0) A	24 V 0.1 (0.1) A 12 V 1.0 (1.0) A 5 V 2.0 (2.0) A

Electrical connection

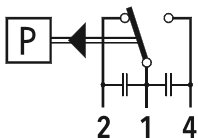

Switch 10/11/23

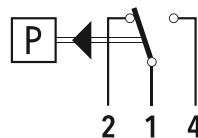

Switch 21/26